

## Commercial Vehicle Bearings



**⚠ WARNING Failure to observe the following warnings could create a risk of serious injury.**

Proper maintenance and handling procedures are critical. Always follow installation instructions and maintain proper lubrication.

Never spin a bearing with compressed air. The rollers may be forcefully expelled.

**Note**

*Timken has taken extreme care in the research and production of this catalog, but cannot under any circumstances be liable for any errors or omissions. Timken reserves the right to modify the contents of this catalog without prior notice. The contents of this catalog are the property of The Timken Company and may not be reproduced, in any form, in whole or in part, without written permission from The Timken Company. Application data may only apply up to the catalog publication date shown on the cover.*

**⚠ ¡ADVERTENCIA! El incumplimiento de las siguientes normas de seguridad puede originar daños físicos a personas.**

Es de vital importancia llevar a cabo unas prácticas adecuadas de mantenimiento y manipulación. No cumplir con las instrucciones de montaje dictadas por el fabricante del vehículo ni realizar una lubricación adecuada de mantenimiento podría provocar fallos en el equipo.

No haga girar nunca un rodamiento con aire comprimido. Los rodillos podrían salir proyectados.

**Nota**

*Timken ha dedicado especial cuidado a la realización de las labores de documentación y elaboración de este catálogo, pero declina cualquier tipo de responsabilidad por errores u omisiones en los que pueda haberse incurrido en la edición del mismo. Timken se reserva el derecho de modificar el contenido de este catálogo sin notificación previa. Este catálogo es propiedad de The Timken Company, no estando autorizada su reproducción, en ningún modo, parcial ni total, si no se cuenta con el permiso escrito de Timken. La información de aplicaciones de productos puede ser válida únicamente hasta la fecha de publicación de este catálogo mostrada en la portada del mismo.*

**⚠ AVERTISSEMENT! Le non-respect des consignes ci-dessous peut engendrer un risque sérieux de dommages corporels.**

Le respect des consignes de montage et de maintenance est essentiel. Le non-respect des instructions de montage fournies par le fabricant du véhicule et une lubrification inappropriée peuvent entraîner un dysfonctionnement de l'appareil.

Ne jamais actionner un roulement avec de l'air comprimé. Les rouleaux peuvent être éjectés violemment.

**Note**

*Timken a apporté toute son attention à l'élaboration et à la production de ce catalogue mais ne peut être tenue pour responsable en cas d'erreur ou d'omission. Timken se réserve le droit de modifier le contenu de ce catalogue sans avertissement préalable. Le contenu de ce catalogue est la propriété de The Timken Company et ne peut être reproduit sous quelque forme que ce soit, dans son intégralité ou partiellement, sans autorisation écrite de The Timken Company. Les informations des différentes applications ne s'appliquent qu'à la date de publication figurant sur la couverture du catalogue.*

**⚠ ACHTUNG! Missachtung der folgenden Warnhinweise kann schwere körperliche Verletzungen verursachen.**

Wartung und Einsatz der Produkte müssen fachgerecht erfolgen. Die Missachtung der Einbauvorschriften des Fahrzeugherstellers und unsachgemäße Schmierung können zu einem Ausfall der Anwendung führen.

Drehen Sie Wälzlager nie mit Druckluft. Die Wälzkörper könnten dabei herausgeschleudert werden.

**Anmerkung**

*Dieser Katalog wurde von Timken mit größter Sorgfalt hergestellt. Die Haftung für etwaige Fehler oder Weglassungen ist ausgeschlossen. Timken behält sich das Recht vor, den Inhalt dieser Druckschrift ohne vorherige Ankündigung zu modifizieren. Der Inhalt dieser Druckschrift ist geistiges Eigentum der Timken Company. Er darf ohne schriftliche Genehmigung in keiner Form, weder als Ganzes noch in Auszügen, reproduziert werden.*

**⚠ ATTENZIONE! La non osservanza delle seguenti raccomandazioni può creare seri rischi di danni fisici.**

L'adozione di procedure corrette di manutenzione e manipolazione è di importanza fondamentale. Il mancato rispetto delle istruzioni di installazione del costruttore del veicolo e una lubrificazione scorretta possono danneggiare l'attrezzatura.

Non utilizzare mai aria compressa per far ruotare un cuscinetto. La forza dell'aria compressa può causare l'espulsione ad alta velocità dei rulli.

**Nota**

*Il presente catalogo è stato redatto a cura di The Timken Company la quale, in nessuna circostanza, potrà essere ritenuta responsabile per eventuali errori o/è omissioni in esso riscontrabili. The Timken Company si riserva il diritto di modificare il contenuto del presente catalogo senza preavviso. Il contenuto di questo documento è di proprietà di The Timken Company e non può essere riprodotto - integralmente o in parte - in nessuna forma senza autorizzazione scritta da parte di The Timken Company. I dati delle applicazioni valgono soltanto fino alla data riportata sulla copertina.*

**⚠ AVISO! A não observação dos seguintes avisos poderá resultar num risco de danos pessoais graves.**

A manutenção e o manuseio apropriados são muito importantes. A não observação das instruções de instalação do fabricante do veículo e a lubrificação inapropriada podem levar a uma avaria do equipamento.

Nunca gire os rolamentos com ar comprimido. Os roletes podem ser projectados a alta velocidade.

**Note**

*A Timken dedicou um especial cuidado à pesquisa e elaboração deste catálogo, mas não pode assumir, em qualquer circunstância, responsabilidade por eventuais erros ou omissões. A Timken reserva-se o direito de alterar o conteúdo deste catálogo sem aviso prévio. Todo o conteúdo deste catálogo é propriedade de The Timken Company e não pode ser reproduzido, em qualquer meio ou forma, no todo ou em parte, sem a permissão escrita de The Timken Company. Os dados relativos às aplicações poderão aplicar-se apenas até à data de publicação do catálogo indicada na capa.*

## Index

**A. Application listings - Wheel End . . . . . p. A1**

*Truck . . . . . p. A3*

*Trailer . . . . . p. A189*

*Bus . . . . . p. A205*

*Light Commercial Vehicle . . . p. A241*

**B. Applications listings - Final drive. . . . . p. B1**

**C. Product information . . . . . p. C1**

*Numerical Listings. . . . . p. C3*

*Dimensional Guide . . . . . p. C15*

*Cross-Reference Guide. . . . . p. C17*

*Fitting Instructions. . . . . p. C27*

*Bearing Damage Analysis. . . p. C31*

*Maintenance Tools. . . . . p. C35*



# APPLICATION LISTINGS - WHEEL END

# A

## ***Application listings - Wheel End***

*Truck* . . . . . p. A3

*Trailer* . . . . . p. A189

*Bus* . . . . . p. A205

*Light Commercial Vehicle* . . . . . p. A241

A



**APPLICATION LISTINGS - WHEEL END**

**A**

# APPLICATION LISTINGS - TRUCK

















A



# APPLICATION LISTINGS - TRUCK





				 			
<b>AWD</b>							
<b>TL 16</b>							
	EATON 16 SERIES EATON 16 SERIES		SET401 560/552A				
<b>TL 24</b>							
	ROCKWELL 55 MD ROCKWELL 55 MD		SET404 SET401				
<b>TL 27</b>							
	ROCKWELL 55 MD ROCKWELL 55 MD		SET404 SET401				
<b>BEDFORD</b>							
<b>BFP/BRP/SB/VAM</b>							
	YRQ YRQ	SET278 SET1119					
<b>KC TK 750</b>							
	3-4 T, 6000 LBS 3-4 T, 6000 LBS 3-4 T, 13440 LBS 3-4 T, 13440 LBS	528R/522 2580/2520	482/472 SET1061				
<b>KC TK 1470</b>							
	9-14 T, 13200 LBS 9-14 T, 13200 LBS 9-14 T, 18200 LBS, 2 SPEED 9-14 T, 18200 LBS, 2 SPEED	H414245X/H414210 SET123	SET403 SET1135				
<b>KD 750</b>							
	5 T, 6000 LBS 5 T, 6000 LBS 5 T, 13440 LBS 5 T, 13440 LBS	528R/522 2580/2520	482/472 SET1061				
<b>KD 860</b>							
	11.75 T, 6000 LBS 11.75 T, 6000 LBS 11.75 T, 13440 LBS 11.75 T, 13440 LBS	528R/522 2580/2520	482/472 SET1061				
<b>KE TK 1000</b>							
	6-8 T, 8200/9600 LBS 6-8 T, 8200/9600 LBS 7-10 T, 8200/9600 LBS	SET278 SET1119 SET278					



























# APPLICATION LISTINGS - TRUCK



A















				 			
<b>BEDFORD</b>							
<b>KE TK 1000 ...</b>							
	7-10 T, 8200/9600 LBS 15 T, 8200/9600 LBS 15 T, 8200/9600 LBS 6-8 T, 19040 LBS, 2 SPEED BEDFORD 6-8 T, 19040 LBS, 2 SPEED BEDFORD 6-8 T, 18220 SERIES, 2 SPEED EATON 6-8 T, 18220 SERIES, 2 SPEED EATON 15 T, 17472/19040, SINGLE SPEED 15 T, 17472/19040, SINGLE SPEED 6-8 T, 17472/19040, SINGLE SPEED 6-8 T, 17472/19040, SINGLE SPEED 7-10 T, 17472/19040, SINGLE SPEED 7-10 T, 17472/19040, SINGLE SPEED 7-10 T, 19040 LBS, 2 SPEED BEDFORD 7-10 T, 19040 LBS, 2 SPEED BEDFORD 7-10 T, 18220 SERIES, 2 SPEED EATON 7-10 T, 18220 SERIES, 2 SPEED EATON	<b>SET1113</b> <b>SET278</b> <b>SET1119</b>	575S/572 478XA/473XS SET403 SET1135 42686/42624 SET1061 42686/42624 SET1061 42686/42624 SET1061 575S/572 478XA/473XS SET403 SET1135				
<b>KF 60 TK 1630/1930</b>							
	8200/9600 LBS 8200/9600 LBS 17472/19040 LBS, KGL/KGS 60 17472/19040 LBS, KGL/KGS 60 18220 SERIES, 2 SPEED EATON 18220 SERIES, 2 SPEED EATON 17472/19040, SINGLE SPEED BEDFORD 17472/19040, SINGLE SPEED BEDFORD 19040 LBS, 2 SPEED BEDFORD 19040 LBS, 2 SPEED BEDFORD 22500 SINGLE SPEED BEDFORD 22500 SINGLE SPEED BEDFORD	<b>SET278</b> <b>SET1119</b>	575S/572 478XA/473XS SET403 478XA/473XS 42686/42624 SET1061 575S/572 478XA/473XS SET1067 SET1065				
<b>KFA TRACTOR</b>							
	16 T, 8200/9600 LBS 16 T, 8200/9600 LBS 16T, 17472/19040 LBS 16T, 17472/19040 LBS	<b>SET278</b> <b>SET1119</b>	575S/572 478XA/473XS				
<b>KG TK 1260</b>							
	7.5-12 T, 8200/9600 LBS 7.5-12 T, 8200/9600 LBS 7.5-12 T, 17472/19040, SINGLE SPEED 7.5-12 T, 17472/19040, SINGLE SPEED 7.5-12 T, 19040 LBS, 2 SPEED 7.5-12 T, 19040 LBS, 2 SPEED 7.5 -12 T, 18220 SERIES, 2 SPEED EATON 7.5 -12 T, 18220 SERIES, 2 SPEED EATON	<b>SET278</b> <b>SET1119</b>	575S/572 478XA/473XS 575S/572 478XA/473XS SET403 SET1135				
<b>KGA TRACTOR</b>							
	19 T, 8200/9600 LBS 19 T, 8200/9600 LBS 19 T, 19040 LBS, 2 SPEED BEDFORD 19 T, 19040 LBS, 2 SPEED BEDFORD	<b>SET278</b> <b>SET1119</b>	575S/572 478XA/473XS				







				 			
<b>BEDFORD</b>							
<b>KHA TRACTOR</b>							
	22 T, 13200 LBS 22 T, 13200 LBS 22 T, 22500 LBS 22 T, 22500 LBS	H414245X/H414210 SET123	SET1067 SET1065				
<b>KM [6X2]</b>							
	13200 LBS 13200 LBS 22500 LBS 22500 LBS	H414245X/H414210 SET123	SET1067 SET1065				
<b>KM [6X4]</b>							
	20 T, 13200 LBS 20 T, 13200 LBS 22 T, 13200 LBS 22 T, 13200 LBS 22 T, 19000 LBS, 38DT, EATON BOGIE 22 T, 19000 LBS, 38DT, EATON BOGIE 20 T, 17000 LBS, 30DT, EATON BOGIE 20 T, 17000 LBS, 30DT, EATON BOGIE	H414245X/H414210 SET123 H414245X/H414210 SET123	SET403 SET1135 SET401 560/552A				
<b>KM TA 1630</b>							
	22 T, 13200 LBS 22 T, 13200 LBS 10-11 T, 13200 LBS 10-11 T, 13200 LBS 10-11 T, 22500 LBS 10-11 T, 22500 LBS 22 TON 22, 500 LBS 22 TON 22, 500 LBS 10-11 T, 18220 SERIES, 2 SPEED EATON 10-11 T, 18220 SERIES, 2 SPEED EATON 22 T, 18220 SERIES, 2 SPEED EATON 22 T, 18220 SERIES, 2 SPEED EATON	H414245X/H414210 SET123 H414245X/H414210 SET123	SET1067 SET1065 SET1067 SET1065 SET403 SET1135 SET403 SET1135				
<b>KM TRACTOR</b>							
	32 T, 13200 LBS 32 T, 13200 LBS 32 T, 22500 LBS 32 T, 22500 LBS	H414245X/H414210 SET123	SET1067 SET1065				
<b>TL 570/750/860</b>							
	6000 LBS 6000 LBS 13440 LBS 13440 LBS 13440 LBS 13440 LBS	528R/522 2580/2520	482A/472 3977X/3921XA 482A/472		- 07/1982 - 07/1982 07/1982 - 07/1982 -		
<b>TL 1000/1260</b>							
	8200/9600 LBS 8200/9600 LBS	SET278 SET1119					



# APPLICATION LISTINGS - TRUCK

A











				 					
<b>BEDFORD</b>									
<b>TL 1470</b>									
	13200 LBS 13200 LBS 18220 SERIES, 2 SPEED EATON 18220 SERIES, 2 SPEED EATON	H414245X/H414210 SET123		SET403 SET1135					
<b>TL 1500</b>									
	18220 SERIES, 2 SPEED EATON			SET403					
<b>TL 1630</b>									
	13200 LBS 13200 LBS 17472/19040 LBS, SINGLE SPEED 17472/19040 LBS, SINGLE SPEED 17472/19040 LBS, SINGLE SPEED 19040 LBS, 2 SPEED 19040 LBS, 2 SPEED 19040 LBS, 2 SPEED 18220 SERIES, 2 SPEED EATON 18220 SERIES, 2 SPEED EATON	H414245X/H414210 SET123		SET1061 42686/42624 SET1061 575S/572 478XA/473XS 478XA/473XS SET403 SET1135		07/82 - -07/82 -07/82 -07/82 -07/82 07/82 -			
<b>TL 1650</b>									
	18220 SERIES, 2 SPEED EATON 17472/19040LBS, SINGLE SPEED			SET1135 478XA/473XS		-07/82			
<b>TL 1930</b>									
	8200/9600 LBS 8200/9600 LBS 17472/19040LBS, SINGLE SPEED 18220 SERIES, 2 SPEED EATON 18220 SERIES, 2 SPEED EATON	SET278 SET1119		SET1061 SET403 SET1135		07/82 -			
<b>TM 1700</b>									
	13200 LBS, RIGID, BEDFORD 500 ENGINE 13200 LBS, RIGID, BEDFORD 500 ENGINE 13200 LBS, RIGID, DETROIT ENGINE 13200 LBS, RIGID, DETROIT ENGINE 19128 LBS, SINGLE SPEED, SPIRAL BEVEL 19128 LBS, SINGLE SPEED, SPIRAL BEVEL 22500 LBS, RIGID, BEDFORD 500 ENGINE 22500 LBS, RIGID, BEDFORD 500 ENGINE	H414245X/H414210 SET123 H414245X/H414210 SET123		SET403 SET1135 SET1067 SET1065					
<b>TM 2250 [6X4]</b>									
	13200 LBS 13200 LBS DS380 & DSP380, BOGIE EATON DS380 & DSP380, BOGIE EATON	H414245X/H414210 SET123		SET403 SET1135					























											
<b>BEDFORD</b>											
<b>TM 2250/2300/2500/2600/3250 TRACTOR</b>											
	13200 LBS 13200 LBS 19128 LBS, SINGLE SPEED, SPIRAL BEVEL 19128 LBS, SINGLE SPEED, SPIRAL BEVEL 18300 LBS, DOUBLE RED. SPIRAL BEVEL 18300 LBS, DOUBLE RED. SPIRAL BEVEL	H414245X/H414210 SET123		SET403 SET1135 SET403 SET1135		I O I O I O					
<b>TM 3800 TRACTOR</b>											
	13200 LBS 13200 LBS SOMA SOMA ROCKWELL ROCKWELL	H414245X/H414210 SET123		SET1091 SET1047 SET403 SET1137		I O I O I O		10 10			
<b>YRT SERIES</b>											
		H414245X/H414210 SET123		SET1067 SET1065		I O I O					
<b>BRISTOL</b>											
<b>LH SERIES</b>											
		SET1139 SET1119		SET1137 566/563		I O I O					
<b>NATIONAL CHASSIS</b>											
		SET114 SET315		SET109 SET109		I O I O					
<b>RE SERIES</b>											
		558/552A 49175/49368		SET414 SET414		I O I O					
<b>TLH/TLL/TSH/VR</b>											
		H414245X/H414210 SET123		SET414 SET414		I O I O					



# APPLICATION LISTINGS - TRUCK







A

				 			
<b>DAF</b>							
<b>CF 65</b>							
	150N/152N 150N/152N 172N 182N 182N SR1132 SR1132 SR1347 SR1347 AAS1354/AAS1355 TRAILING AXLE TRAILING AXLE	SET1304 SET1079 SET1080 SET1304 SET1079		SET1303 SET1091 SET1303 SET1091 SET1306 681A/672 SET405		ABS/Seal, no integration ABS/Seal, no integration ABS/Seal, no integration ABS/Seal, no integration ABS/Seal, no integration ABS/Seal, no integration ABS/Seal, no integration ABS/Seal, no integration ABS/Seal, no integration ABS/Seal, no integration ABS/Seal, no integration	
<b>CF 75</b>							
	150N 150N 152N 152N 172N SR1132 SR1132 SR1339 SR1339 AAS1354 AAS1355 HR1346 HR1346 TRAILING AXLE TRAILING AXLE	SET1304 SET1079 SET1304 SET1079 SET1080		SET1303 SET1091 SET1303 SET1091 SET1306 SET1306 SET1303 SET1091 681A/672 SET405		ABS/Seal, no integration ABS/Seal, no integration ABS/Seal, no integration ABS/Seal, no integration ABS/Seal, no integration ABS/Seal, no integration ABS/Seal, no integration ABS/Seal, no integration ABS/Seal, no integration ABS/Seal, no integration ABS/Seal, no integration ABS/Seal, no integration	
<b>CF 85</b>							
	152N 152N 172N 182N 182N SR1347 SR1347 AAS1354 HR1355 TRAILING AXLE TRAILING AXLE	SET1304 SET1079 SET1080 SET1304 SET1079		SET1303 SET1091 SET1306 SET1306 681A/672 SET405		ABS/Seal, no integration ABS/Seal, no integration ABS/Seal, no integration ABS/Seal, no integration ABS/Seal, no integration ABS/Seal, no integration ABS/Seal, no integration ABS/Seal, no integration ABS/Seal, no integration ABS/Seal, no integration	
<b>F95 SERIES</b>							
	152N 152N 172N HR1346 HR1346 AAS1354 AAS1355 TRAILING AXLE TRAILING AXLE	SET1304 SET1079 SET1080		SET1303 SET1091 SET1306 SET1306 681A/672 SET405		3 3	







































				 			
<b>DAF</b>							
<b>F600/F800 SERIES</b>							
	60 N 60 N 512 512	SET1109 32206		SET1125 SET1125			
<b>F1000 SERIES</b>							
	84N 84N 715 715	SET416 SET1119		SET325 SET1178			
<b>F1600 SERIES</b>							
	N94 N94 N100 N100 N142 N142 1635 1635 1635 1635	SET278 SET102 5583/5535 3782/3720 SET1300 SET1079		681A/672 SET1129 SET404 SET1129			Track width 1718mm with 10 bolt  Track width 1718mm with 10 bolt  Track width 1655mm with 8 bolt  Track width 1655mm with 8 bolt 
<b>F1700 SERIES</b>							
	122N	SET1078					
<b>F1800 SERIES</b>							
	1628V 1628V 2255 2255	SET1138 SET262		681A/672 SET405			
<b>F1900 SERIES</b>							
	122N 131N	32309B 32309B					
<b>F2000/F2005 SERIES</b>							
	N100 N100 N122 N122 N142 N142 N142 N142 1635 1635 2255 2255 TRAILING AXLE TRAILING AXLE	5583/5535 3782/3720 6379/6321 3782/3720 SET1300 SET1079 SET1300 SET1110		681A/672 SET1129 681A/672 SET405 681A/672 SET405			   



A

									
									
<b>DAF</b>									
<b>F2100/F2105 SERIES</b>									
	N100	5583/5535							
	N100	3782/3720							
	N142	SET1300						2	
	N142	SET1110						2	
	N142	SET1300						1	11
	N142	SET1079						1	11
	N142	SET1300						1	12
	N142	SET1079						1	12
	2255		681A/672						
	2255		SET405						
	2699		SET508						
	2699		SET1130						
	TRAILING AXLE		681A/672						
	TRAILING AXLE		SET405						
<b>F2200/F2205 SERIES</b>									
	N122	6379/6321							
	N122	3782/3720							
	N142	SET1079						1	12
	N142	SET1079						1	11
	2255		681A/672						
	2255		SET405						
	2676		SET109						
	2676		749A/742						
	2699		SET508						
	2699		SET1130						
	TRAILING AXLE		681A/672						
	TRAILING AXLE		SET405						
<b>F2300/F2305 SERIES</b>									
	N142	SET1300						2	
	N142	SET1110						2	
	N142	SET1300						1	11
	N142	SET1079						1	11
	N142	SET1300						1	12
	N142	SET1079						1	12
	2255		681A/672						
	2255		SET405						
	2699		SET508					3	
	2699		SET1130					3	
	TRAILING AXLE		681A/672						
	TRAILING AXLE		SET405						
<b>F2500/F2503/F2505 SERIES</b>									
	N142	SET1300							
	N142	SET1079							
	2255		681A/672						Exc. FAR
	2255		SET405						Exc. FAR
	2255		681A/672						FAR
	2255		SET405						FAR
	2699		SET1306						Exc. FA & FT
	2699		SET508						FA & FT



































					
<b>DAF</b>					
<b>F2500/F2503/F2505 SERIES ...</b>					
	2699 TRAILING AXLE TRAILING AXLE		SET1130 681A/672 SET405		FA & FT
<b>F2700 SERIES</b>					
	N142 N142 1346 1346	SET1300 SET1079	SET1303 SET1091		
<b>F2800 SERIES</b>					
	140N 140N 140N 140N N140 N140 N140 N140 142N 142N 142N 142N 2255 2255 2699 2699 TRAILING AXLE TRAILING AXLE	SET1300 SET1110 SET1300 SET1110 SET1300 SET1079 SET1300 SET1079 SET1300 SET1079 SET1300 SET1079 681A/672 SET405 SET508 SET1130 681A/672 SET405			                
<b>F2900 SERIES</b>					
	142N 142N 142N 142N 1346 1346 1354 1355	SET1300 SET1079 SET1300 SET1079	SET1303 SET1091 SET1306 SET1306		       
<b>F3200 SERIES</b>					
	142N 142N 1354 TRAILING AXLE TRAILING AXLE	SET1300 SET1079	SET1306 681A/672 SET405		
<b>F3300/3305 SERIES</b>					
	N142 N142 2699 2699 TRAILING AXLE TRAILING AXLE	SET1300 SET1079	SET508 SET1130 681A/672 SET405		



# APPLICATION LISTINGS - TRUCK

A















									
<b>DAF</b>									
<b>F3600 SERIES</b>									
	N142 N142 1346 1346 1355 2699	SET1300 SET1079		SET1303 SET1091 SET1306 SET1306					
<b>LF 45</b>									
	F36 F36 F48 F48 SR5.14 SR5.14	SET1177 32206 SET278 32206		SET1046 SET98					
<b>LF 55</b>									
	F60 F60 152N 152N SR10.20 SR10.20 SR1132 SR1132	SET114 SET1109 SET1304 SET1079		SET1049 495/493 SET1303 SET1091					
<b>N2800 SERIES</b>									
	142N 142N 142N 142N 2699 2699	SET1300 SET1079 SET1300 SET1079		SET508 SET1130			   		
<b>VARIOUS</b>									
	DANA S 130			SET1262					
<b>XF 95</b>									
	150N 150N 152N 152N 172N SR1347 SR1347 AAS1354 AAS1355 TRAILING AXLE TRAILING AXLE	SET1304 SET1079 SET1304 SET1079 SET1080		SET1303 SET1091 SET1306 SET1306 681A/672 SET405			 /Seal, no integration  /Seal, no integration  /Seal, no integration  /Seal, no integration  /Seal, no integration  /Seal, no integration  /Seal, no integration  /Seal, no integration   /Seal, no integration 		















				 			
<b>DAF</b>							
<b>XF 95.530</b>							
	182N 182N SR1347 SR1347 AAS1354 AAS1355 TRAILING AXLE TRAILING AXLE	SET1304 SET1079		SET1303 SET1091 SET1306 SET1306 681A/672 SET405		I O I O I O I O	ABS/Seal, no integration ABS/Seal, no integration ABS/Seal, no integration ABS/Seal, no integration ABS/Seal, no integration ABS/Seal, no integration
<b>DODGE</b>							
<b>50 SERIES RB S35</b>							
	AX 1 AX 6 AX 6			397XA/394XS SET98 SET1042		I I O	
<b>50 SERIES RB S38/S56</b>							
		SET230 30305				I O	
<b>50 SERIES RB S46</b>							
	AX 6 AX 6 AX 8	SET230 30305		SET98 SET1042 30213		I O I O I	
<b>50 SERIES RB S66</b>							
	AX 9 AX 9	SET230 30305		567X/563 SET98		I O I O	
<b>50 SERIES RB S75</b>							
	AX 9 AX 9	25580/25520 1988/1922		567X/563 SET98		I O I O	
<b>100 SERIES G08/09/10</b>							
	3.5T 3.5T 4X4 4X4 EATON 16000, 2 SPEED EATON 16000, 2 SPEED	SET1009 3778/3720		578X/572 SET98 578X/572 SET98		I O I O I O I	
<b>100 SERIES G15</b>							
	14.5T, KIRKSTALL 14.5T, KIRKSTALL 14.5T, ALFORD & ALDER 5.2 14.5T, ALFORD & ALDER 5.2 EATON 18000, 1 & 2 SPEED	SET1146 SET210 SET412 SET102		SET403		I O I O I	



# APPLICATION LISTINGS - TRUCK

A

				 			
<b>DODGE</b>							
<b>100 SERIES G15 ...</b>							
	EATON 18000, 1 & 2 SPEED			HM515745/HM515716			
<b>100 SERIES G16</b>							
	16T, KIRKSTALL 16T, KIRKSTALL 16T, ALFORD & ALDER 6.5 16T, ALFORD & ALDER 6.5 16 T, EATON 18000 16 T, EATON 18000	SET1146 SET210 SET1146 SET210		SET403 HM515745/HM515716			
<b>100 SERIES G18</b>							
	3.5 T 3.5 T EATON 16000, 2 SPEED EATON 16000, 2 SPEED DODGE AX4 DODGE AX4	3778/3720 SET1009		578X/572 SET98 578X/572 SET98			
<b>100 SERIES G20</b>							
	EATON 16000, 2 SPEED EATON 16000, 2 SPEED AX4 AX4 EATON 18000 EATON 18000	SET278 SET1119		578X/572 SET98 578X/572 SET98 SET403 HM515745/HM515716			
<b>100 SERIES G24</b>							
	KIRKSTALL KIRKSTALL	SET1146 SET210					
<b>100 SERIES G26</b>							
	16T, ALFORD & ALDER 6.5 16T, ALFORD & ALDER 6.5 EATON 18000 EATON 18000	SET1146 SET210		SET403 HM515745/HM515716			
<b>300 SERIES K 3820 P TRACTOR</b>							
	8T 8T 232 N 232 N	H212749/H212710 SET123		SET317 SET414			
<b>ERF</b>							
<b>B SERIES [DRAWBAR]</b>							
	KIRKSTALL, 14000 LBS KIRKSTALL, 14000 LBS KIRKSTALL D85-10.2 KIRKSTALL D85-10.2	SET114 HM204049/10		56426/56650 SET403			















					
<b>ERF</b>					
<b>35/38 C2, 35/38 R2</b>					
	KIRKSTALL, 14000 LBS KIRKSTALL, 14000 LBS KIRKSTALL D85-10.2 KIRKSTALL D85-10.2	SET114 HM204049/10	56426/56650 SET403		
<b>VARIOUS TRUCKS</b>					
	KIRKSTALL S62/S63 KIRKSTALL S62/S63 KIRKSTALL S60 KIRKSTALL S60 ROCKWELL ROCKWELL KIRKSTALL D65 ROCKWELL R170/R180 ROCKWELL R170/R180 GKN D85 10.2 KIRKSTALL D85 KIRKSTALL D85	SET114 HM204049/10 SET110 615/612 H414249/H414210 SET210	SET1132 SET403 SET1137 SET403 56426/56650 SET403		
<b>FODEN</b>					
<b>200 SERIES</b>					
	GKN S63 GKN S63 24T, G.V.W 24T, G.V.W	SET114 HM204049/10 SET113 SET315			
<b>FLEETMASTER TRACTOR UNIT</b>					
	FODEN 6.5T FODEN 6.5T ROCKWELL 11.3T ROCKWELL 11.3T	SET113 SET315	SET113 SET401		
<b>HAULMASTER [6X4]</b>					
	FODEN 6.5T FODEN 6.5T 10T 10T ROCKWELL SRQHD BOGIE ROCKWELL SRQHD BOGIE	SET113 SET315	SET405 SET289 SET404 SET401		
<b>HAULMASTER [8X4]</b>					
	FODEN 6.5T FODEN 6.5T 10T 10T	SET113 SET315	SET405 SET289		
<b>RIGID [6X4]</b>					
	24T, G.V.W 24T, G.V.W 24T, G.V.W, HIGH SPEED HUB RED. 24T, G.V.W, HIGH SPEED HUB RED. 24T, G.V.W-10T, SINGLE RED.	SET113 SET315	74550/74850 SET289 SET405		









# APPLICATION LISTINGS - TRUCK



A















					
<b>FODEN</b>					
<b>RIGID [6X4] ...</b>					
	24T, G.V.W-10T, SINGLE RED.		SET289		
<b>RIGID MIXER [6X4]</b>					
	24T, G.V.W 24T, G.V.W 24T, G.V.W-EATON 24T, G.V.W-EATON	SET113 SET315	SET403 SET1135		
<b>RIGID TIPPER [8X4]</b>					
	30T, G.V.W 30T, G.V.W 30T, G.V.W, HIGH SPEED HUB RED. 30T, G.V.W, HIGH SPEED HUB RED. 30T, G.V.W, 10T, SINGLE RED. 30T, G.V.W, 10T, SINGLE RED.	SET113 SET315	74550/74850 SET289 SET405 SET289		
<b>S 10</b>					
	FODEN 6.5T FODEN 6.5T 10T 10T	SET113 SET315	SET405 SET289		
<b>SIXER</b>					
	FODEN 6.5T FODEN 6.5T EATON D58 7380 EATON D58 7380	SET113 SET315	SET403 SET1135		
<b>TIPPER [8X4]</b>					
	32T, G.V.W-FODEN 6.5T 32T, G.V.W-FODEN 6.5T 32T, G.V.W 32T, G.V.W	SET113 SET315	74550/74850 SET289		
<b>TRACTOR UNIT [4X2]</b>					
	26T, G.V.W 26T, G.V.W 26T, G.V.W, FODEN 10T, SINGLE RED. 26T, G.V.W, FODEN 10T, SINGLE RED.	SET113 SET315	SET405 SET289		
<b>UNIVERSAL 38 T</b>					
	FODEN 6.5T FODEN 6.5T EATON D58 7380 EATON D58 7380 KIRKSTALL S 62 KIRKSTALL S 62	SET113 SET315	SET403 SET1135 HM212044/HM212011 HM204049/10		

				 			
<b>HINO</b>							
<b>FS 271 KD</b>							
		SET1082 SET1079				I O	
<b>FS 275</b>							
		SET1082 SET1079	SET1067 SET1066			I O I O	
<b>SH 283 KA</b>							
		SET1082 SET1079				I O	
<b>IVECO</b>							
<b>50-9</b>							
	IVECO 5822 IVECO 5822 IVECO 4516HD IVECO 4516HD IVECO 4419 [N050-9 D/V] IVECO 4419 [N050-9 D/V]	SET1031 SET1030	SET1044 SET1044 SET1100 SET1100			I O I O I O	-12/86 -12/86 01/87 - 01/87 -
<b>55-8/9/10 [I SERIES]</b>							
	IVECO 5822/IVECO 5830 IVECO 5822/IVECO 5830 IVECO 4516 IVECO 4516	SET1031 SET1030	SET1100 SET1100			I O I O	
<b>A 55-10/60-10/A 60-10 [I-II SERIES]</b>							
	IVECO 5822/IVECO 5830 IVECO 5822/IVECO 5830 IVECO 4516 IVECO 4516	SET1031 SET1030	SET1100 SET1100			I O I O	
<b>60-8 [III SERIES]</b>							
	IVECO 5822/IVECO 5830 IVECO 5822/IVECO 5830 IVECO 4516 IVECO 4516	SET1031 SET1030	SET1100 SET1100			I O I O	
<b>65-9/EXPORT CKD, 65-12/D/H/V</b>							
	IVECO 5827 IVECO 5827 IVECO 5830 IVECO 5830 IVECO 4519 IVECO 4519 IVECO 4517 IVECO 4517	SET1195 SET1199 SET1031 SET1030	SET1100 SET1100 SET1293 SET1293			I O I O I O I O	









# APPLICATION LISTINGS - TRUCK

A

				 			
<b>IVECO</b>							
<b>70-10 [I SERIES]</b>							
	IVECO 5830 IVECO 5830 IVECO 4519 IVECO 4519	SET1031 SET1030		SET1100 SET1100			
<b>A 70-12 [I-II SERIES] / A 70-14</b>							
	IVECO 5830 IVECO 5830 IVECO 4519 IVECO 4519	SET1031 SET1030		SET1100 SET1100			
<b>75-13/16 AW</b>							
	IVECO 5918 [AVA 36] IVECO 5918 [AVA 36] IVECO 7899 [HA 72] IVECO 7899 [HA 72]	SET1047 47487/47420		SET1047 47487/47420			
<b>75-13 WM [4X4] / 75-14 WM</b>							
	IVECO 5918 [AVA 36] IVECO 5918 [AVA 36] IVECO 4518 IVECO 4518	SET1047 47487/47420		SET1047 47487/47420			
<b>79-11 / 79-12 D</b>							
	IVECO 5830 IVECO 5830 IVECO 4519 IVECO 4519	SET1031 SET1030		SET1100 SET1100			
<b>79-12 V/CKD, 79-14/D/V</b>							
	IVECO 5830 IVECO 5830 IVECO 4519 IVECO 4519	SET1031 SET1030		SET1100 SET1100			
<b>80-13 [I SERIES]</b>							
	IVECO 5830 IVECO 5830 IVECO 5822 IVECO 5822	SET1031 SET1030 SET1031 SET1030					
<b>80-13 A/AH/AT, 80-16 A</b>							
	IVECO 582201 IVECO 582201 IVECO 5830 IVECO 5830 ROCKWELL 125E01 ROCKWELL 125E01	SET1031 SET1030 SET1031 SET1030		SET349 SET98			01/85 - 01/85 -  01/85 - 01/85 -
<b>80-13 AW / 80-16 AW [4X4]</b>							
	IVECO 5918 [AVA 36] IVECO 5918 [AVA 36] IVECO 7899 [HA 72]	XAA33212-90KA1 SET1109		SET1047			



































											
<b>IVECO</b>											
<b>80-13 AW / 80-16 AW [4X4] ...</b>											
	IVECO 7899 [HA 72]				47487/47420						
<b>80-14/17 W</b>											
	IVECO 5918 [AVA 36] IVECO 5918 [AVA 36] IVECO 4518 IVECO 4518	SET1047 47487/47420			SET1047 47487/47420						
<b>90-13/A90-13 [I-II SERIES]</b>											
	IVECO 5830 IVECO 5830 IVECO 5822 IVECO 5822	SET1031 SET1030 SET1031 SET1030									
<b>90-13 A/AH, A90-14 [III-IV SERIES]</b>											
	IVECO 5830 IVECO 5830 IVECO 5822 IVECO 5822 ROCKWELL [125E] ROCKWELL [125E]	SET1031 SET1030 SET1031 SET1030			SET349 SET98						
<b>90-14 WM [4X4] / 90-17 WM</b>											
	IVECO 5918 [AVA 36] IVECO 5918 [AVA 36] IVECO 4518 IVECO 4518	SET1047 47487/47420			SET1047 47487/47420						
<b>90-16 AW</b>											
	IVECO 5918 [AVA 36] IVECO 5918 [AVA 36] IVECO 7899 [HA 72] IVECO 7899 [HA 72]	SET1047 47487/47420			SET1047 47487/47420						
<b>95-14 [III-IV SERIES]</b>											
	IVECO 5830 IVECO 5830 IVECO 5822 IVECO 5822 ROCKWELL [125E] ROCKWELL [125E]	SET1031 SET1030 SET1031 SET1030			SET349 SET98						- 01/85 - 01/85 - 01/85 - 01/85
<b>100 E15/E18</b>											
	IVECO 5833 IVECO 5833 IVECO 4517 IVECO 4517 IVECO 4521 IVECO 4521 ROCKWELL [F120-F125] ROCKWELL [F120-F125]	SET1195 SET1199			SET1293 SET1293 SET1207 SET1207 SET349 SET98						



# APPLICATION LISTINGS - TRUCK

A















									
									
<b>IVECO</b>									
<b>100 E17</b>									
	IVECO 5833 IVECO 5833 IVECO 4521 IVECO 4521	SET1195 SET1199		SET1207 SET1207					
<b>109-14/CKD</b>									
	IVECO 5830  ROCKWELL [H140E] ROCKWELL [H140E]	SET1107 SET1031 SET1030		SET1286 SET325			12/85 - 12/85 -		
<b>110-16 A/AH</b>									
	IVECO [VA43] IVECO [VA43] IVECO 4540 IVECO 4540	SET1060 32208		SET1022 SET1064					
<b>115-14/17/17 H [I-II SERIES]</b>									
	IVECO 5844M IVECO 5844M ROCKWELL [H125-P130] ROCKWELL [H125-P130]	SET1112 SET1111		SET1286 SET325					
<b>115-17 [II SERIES]</b>									
	ROCKWELL [H140E] ROCKWELL [H140E]			SET1286 SET325					
<b>120-13/14 [II SERIES]</b>									
	IVECO 5850 IVECO 5850 IVECO 4528/2	SET1081 30311		SET1066					
<b>120-17 ANW</b>									
		SET1022 30215		SET1026 SET1024					
<b>120 E15/E15 H/E18/E18 H</b>									
	IVECO 5842/5851 IVECO 5842/5851 ROCKWELL [H125-P130] ROCKWELL [H125-P130]	SET1201 SET1201		SET1286 SET325					
<b>120 E21 H</b>									
				SET1286 SET325					
<b>130-13 A/AH, 130-16 A/AH</b>									
	IVECO [VA43] IVECO [VA43] IVECO 4540 IVECO 4540	SET1060 32208		SET1022 SET1064					







											
<b>IVECO</b>											
<b>130 E28 TECTOR</b>											
				SET1201 SET1201		SET1286 SET325					
<b>130-M7 FAL CKD</b>											
	IVECO 5918 [AVA36] IVECO 5918 [AVA36] IVECO 7899 [HA72] IVECO 7899 [HA72]		47487/47420 SET1047		47487/47420 SET1047						
<b>A135-14 [5000]/CKD</b>											
	IVECO 5844M IVECO 5844M ROCKWELL [H140E] ROCKWELL [H140E]		SET1112 SET1111		SET1286 SET325				12/85 - 12/85 - 12/85 - 12/85 -		
<b>A135-17 [5000]/[4400] CKD</b>											
	IVECO 5844M IVECO 5844M ROCKWELL [H140E] ROCKWELL [H140E]		SET1112 SET1111		SET1286 SET325				12/85 - 12/85 - 12/85 - 12/85 -		
<b>135-14 H/HCKD, 135-14 [H]</b>											
	IVECO 5844M IVECO 5844M ROCKWELL [H140E] ROCKWELL [H140E]		SET1112 SET1111		SET1286 SET325				12/85 - 12/85 - 12/85 - 12/85 -		
<b>135-14 [H] / CKD</b>											
	IVECO 5844M IVECO 5844M ROCKWELL [H140E] ROCKWELL [H140E]		SET1112 SET1111		SET1286 SET325				12/85 - 12/85 - 12/85 - 12/85 -		
<b>135-17 [H], 135-17 H/HCKD</b>											
	IVECO 5844M IVECO 5844M ROCKWELL [H140E] ROCKWELL [H140E]		SET1112 SET1111		SET1286 SET325				12/85 - 12/85 - 12/85 - 12/85 -		
<b>135-17 [HO CKD] / 135-17 T</b>											
	IVECO 5844M IVECO 5844M ROCKWELL [H140E] ROCKWELL [H140E]		SET1112 SET1111		SET1286 SET325				12/85 - 12/85 - 12/85 - 12/85 -		
<b>135-17 [I SERIES]/[II SERIES]</b>											
	IVECO 5844M IVECO 5844M ROCKWELL [H140E] ROCKWELL [H140E]		SET1112 SET1111		SET1286 SET325						



# APPLICATION LISTINGS - TRUCK

A







				 			
<b>IVECO</b>							
<b>A135-17 [II SERIES]</b>							
	IVECO 5844M IVECO 5844M ROCKWELL [H140E] ROCKWELL [H140E]	SET1112 SET1111		SET1286 SET325			
<b>140-14 [II SERIES] / 140-20 [II SERIES]</b>							
	IVECO 5850 IVECO 5850 IVECO 4542 IVECO 4542	SET1081 30311		SET1068 SET1066			
<b>145-17 [II SERIES]</b>							
	IVECO 5844M IVECO 5844M ROCKWELL [S180E] ROCKWELL [S180E]	SET1112 SET1111		SET1287 SET1286			
<b>150-14 [II SERIES] / 150-16 A [II SERIES]</b>							
	IVECO 5850 IVECO 5850 IVECO 4542 IVECO 4542	SET1081 30311		SET1068 SET1066			
<b>150-17 [I SERIES][II SERIES]</b>							
	IVECO 5850 IVECO 5850 IVECO 4542 IVECO 4542	SET1081 30311		SET1068 SET1066			
<b>150 E18 TECTOR</b>							
				SET1287 SET1286			
<b>159-17/20 [I SERIES], 159-17B/16A [II SERIES]</b>							
	IVECO 5860 IVECO 5860 IVECO 4542 IVECO 4542	6386/6320 SET1079		SET1068 SET1066			
<b>160-23 AH</b>							
	IVECO 5875 IVECO 5875 IVECO 4590 IVECO 4590	SET115 SET1080		SET1053 SET1026			
<b>160-23 AHW/ANW [4X4]</b>							
	IVECO 5965/5975 IVECO 5965/5975 IVECO 4590 IVECO 4590	SET1051 SET1091		SET1053 SET1026			







											
<b>IVECO</b>											
<b>160-26</b>											
	IVECO 5865 IVECO 5865 IVECO 4560 IVECO 4560	6386/6320 SET1079		SET1070 6581X/6535							
<b>160-30 AHW</b>											
	IVECO 5965/5975 IVECO 5965/5975 IVECO 4590 IVECO 4590	SET1051 SET1091		SET1053 SET1026							
<b>165-24 [II SERIES]</b>											
	IVECO 5860 IVECO 5860 IVECO 4542 IVECO 4542	6386/6320 SET1079		SET1068 SET1066							
<b>170/190-20/26/35</b>											
	IVECO 5865 IVECO 5865 IVECO 4590 IVECO 4590	6386/6320 SET1079		SET1053 SET1026							
<b>170-23/25/34 AH/AHW</b>											
		SET115 SET1080 SET1051 SET1091		SET1053 SET1026						RWD RWD FWD FWD	
<b>175-17/24/24T, 175-24 NETT./URB</b>											
	IVECO 5860 IVECO 5860 IVECO 5865 IVECO 5865 ROCKWELL [R130-S180] ROCKWELL [R130-S180] ROCKWELL [S160E] ROCKWELL [S160E]	6386/6320 SET1079 6386/6320 SET1079		SET1287 SET1286 SET1287 SET1286							
<b>175-24 CKD, A 175-24</b>											
	IVECO 5860 IVECO 5860 IVECO 5865 IVECO 5865 ROCKWELL [R130-S180] ROCKWELL [R130-S180] ROCKWELL [S160E] ROCKWELL [S160E]	6386/6320 SET1079 6386/6320 SET1079		SET1287 SET1286 SET1287 SET1286							



# APPLICATION LISTINGS - TRUCK

A

















				 			
<b>IVECO</b>							
<b>190-25 AN/ANT/ANCKD</b>							
	IVECO 5875 IVECO 5875 IVECO 4590 IVECO 4590	SET115 SET1080		SET1053 SET1026			
<b>190-25 AN [TAM]/AHT/[256M19]</b>							
	IVECO 5875 IVECO 5875 IVECO 4590 IVECO 4590	SET115 SET1080		SET1053 SET1026			
<b>190-25 ANW [4X4]</b>							
	IVECO 5975/5965 IVECO 5975/5965 IVECO 4590 IVECO 4590	SET1051 SET1091		SET1053 SET1026			
<b>190-26 H/HT/HCKD</b>							
	IVECO 5875 IVECO 5875 IVECO 4590 IVECO 4590	SET115 SET1080		SET1053 SET1026			
<b>190-26 N [CB5] NT [CB5] / 190-26 N CKD</b>							
	IVECO 5875 IVECO 5875 IVECO 4590 IVECO 4590	SET115 SET1080		SET1053 SET1026			
<b>190-26 HW [4X4]</b>							
	IVECO 5975/5965 IVECO 5975/5965 IVECO 4590 IVECO 4590	SET1051 SET1091		SET1053 SET1026			
<b>190-29 290 M19</b>							
	IVECO 5875 IVECO 5875 IVECO 4590 IVECO 4590	SET115 SET1080		SET1053 SET1026			
<b>190-30</b>							
	IVECO 5875 IVECO 5875 ROCKWELL U SERIES ROCKWELL U SERIES	SET115 SET1080		SET1070 SET1286			
<b>190-30 G.V.-06/88, 190-30 TRU-01/85</b>							
	IVECO 5875 IVECO 5875 ROCKWELL [U180E] ROCKWELL [U180E]	SET115 SET1080		SET1070 SET1286			

											
<b>IVECO</b>											
<b>190-30 H CKD</b>											
	IVECO 5830 IVECO 5830 IVECO 4519 IVECO 4519	SET1031 SET1030		SET1100 SET1100							
<b>190-30 HW</b>											
	IVECO 5965/5975 IVECO 5965/5975 IVECO 4590 IVECO 4590	SET1091 SET1051		SET1053 SET1026							
<b>190-30 PT. RANGE/PT GR. VOL./PT T. RANGE</b>											
	IVECO 5875 IVECO 5875 ROCKWELL [U180E] ROCKWELL [U180E]	SET115 SET1080		SET1070 SET1286							
<b>190-30 T EKO [T-UN]/T T. RANGE/PT GR. VOL.T</b>											
	IVECO 5875 IVECO 5875 ROCKWELL [U180E] ROCKWELL [U180E]	SET115 SET1080		SET1070 SET1286							
<b>190-30 N/NT</b>											
	IVECO 5875 IVECO 5875 IVECO 4590 IVECO 4590	SET115 SET1080		SET1053 SET1026							
<b>190-32 320 M19</b>											
	IVECO 5875 IVECO 5875 IVECO 4590 IVECO 4590	SET115 SET1080		SET1053 SET1026							
<b>190-32 P/PT GR. VOL.</b>											
	IVECO 5875 IVECO 5875 ROCKWELL [U180E] ROCKWELL [U180E]	SET115 SET1080		SET1070 SET1286							
<b>190-35</b>											
	IVECO 5865 IVECO 5865 IVECO 4560 IVECO 4560	6386/6320 SET1079		SET1070 6581X/6535							
<b>190-36 360 M19</b>											
	IVECO 5875 IVECO 5875 IVECO 4590 IVECO 4590	SET115 SET1080		SET1053 SET1026							









# APPLICATION LISTINGS - TRUCK

A

													
<b>IVECO</b>													
<b>190-36 PT. RANGE/PT T.RANGE/T. RANGE</b>													
	IVECO 5875 IVECO 5875 ROCKWELL [U180E] ROCKWELL [U180E]	SET115 SET1080		SET1070 SET1286									
<b>190-36 PT/P/T/TT TURBOSTAR</b>													
	IVECO 5875 IVECO 5875 ROCKWELL [U180E] ROCKWELL [U180E]	SET115 SET1080		SET1070 SET1286									
<b>190-38 /[T-UN]/T [T-UN]/T.R.U.</b>													
	IVECO 5875 IVECO 5875 ROCKWELL [U180E] ROCKWELL [U180E]	SET115 SET1080		SET1070 SET1286									
<b>190-42/PH/T</b>													
	IVECO 5875 IVECO 5875 ROCKWELL [U180E] ROCKWELL [U180E]	SET115 SET1080		SET1070 SET1286									
<b>220-30 PT [6X2] T-UN/T.R.U. [- 01/85]</b>													
	IVECO 5875 IVECO 5875 ROCKWELL [U180E] ROCKWELL [U180E]	SET115 SET1080		SET1070 SET1286									
<b>220-32 AHT</b>													
	IVECO 5875 IVECO 5875 IVECO 4590 IVECO 4590	SET115 SET1080		SET1053 SET1026									
<b>230-35 WM [6X6]</b>													
	IVECO 5965/5975 IVECO 5965/5975 IVECO 4590 IVECO 4590	SET1051 SET1091		SET1053 SET1026									
<b>220-36 [- 04/87], 220-36 P/PT [6X2] T RANGE</b>													
	IVECO 5875 IVECO 5875 ROCKWELL [U180E] ROCKWELL [U180E]	SET115 SET1080		SET1070 SET1286									
<b>220-36 360 M22, 220-38</b>													
	IVECO 5875 IVECO 5875 IVECO 4590 IVECO 4590	SET115 SET1080		SET1053 SET1026									























					
<b>IVECO</b>					
<b>220-38 T.R.U. [- 01/85]</b>					
	IVECO 5875 IVECO 5875 ROCKWELL [U180E] ROCKWELL [U180E]	SET115 SET1080	SET1070 SET1286	I O I O	
<b>240-26/T.R.U. [- 06/88]</b>					
	IVECO 5875 IVECO 5875 ROCKWELL [U180E] ROCKWELL [U180E]	SET115 SET1080	SET1070 SET1286	I O I O	
<b>240-30 [- 01/85] / T.R.U. [- 01/85], 240-30 P [6X2] T-UN</b>					
	IVECO 5875 IVECO 5875 ROCKWELL [U180E] ROCKWELL [U180E]	SET115 SET1080	SET1070 SET1286	I O I O	
<b>240-30</b>					
	IVECO 5875 IVECO 5875 IVECO 4590 IVECO 4590	SET115 SET1080	SET1053 SET1026	I O I O	
<b>240-36 [- 04/87] / T.S [- 06/88] / P [6X2] T RANGE</b>					
	IVECO 5875 IVECO 5875 ROCKWELL [U180E] ROCKWELL [U180E]	SET115 SET1080	SET1070 SET1286	I O I O	
<b>240-38</b>					
	IVECO 5875 IVECO 5875 IVECO 4590 IVECO 4590	SET115 SET1080	SET1053 SET1026	I O I O	
<b>260-25 AH [6X4]/[6X6], 260-32 AH [ARMY], 260-35 HM [6X4] [6X6]</b>					
	IVECO 5875 IVECO 5875 IVECO 5965/5975 IVECO 5965/5975 IVECO 4590 IVECO 4590	SET115 SET1080 SET1051 SET1091	SET1053 SET1026	I O I O I O	
<b>260-32 AH [ARMY] / 260-35 HM [6X4] [6X6]</b>					
	IVECO 5875 IVECO 5875 IVECO 5965/5975 IVECO 5965/5975 IVECO 4590 IVECO 4590	SET115 SET1080 SET1051 SET1091	SET1053 SET1026	I O I O I O	



# APPLICATION LISTINGS - TRUCK







A















					
<b>IVECO</b>					
<b>260-25 AHW [6X6] / 260-26 NW [6X6]</b>					
	IVECO 5875 IVECO 5875 IVECO 5965/5975 IVECO 5965/5975 IVECO 4590 IVECO 4590	SET115 SET1080 SET1051 SET1091		SET1053 SET1026	
<b>260-35 HWM [6X6] / 260-35 WM [6X6]</b>					
	IVECO 5875 IVECO 5875 IVECO 5965/5975 IVECO 5965/5975 IVECO 4590 IVECO 4590	SET115 SET1080 SET1051 SET1091		SET1053 SET1026	
<b>300-30 AH [8X4]</b>					
	IVECO 5875 IVECO 5875 IVECO 4590 IVECO 4590	SET115 SET1080		SET1053 SET1026	
<b>320 D 26 AK CKD</b>					
	IVECO 5830 IVECO 5830 IVECO 4519 IVECO 4519	SET1031 SET1030		SET1100 SET1100	
<b>320-45 HWMT [6X6]</b>					
	IVECO 5965/5975 IVECO 5965/5975 IVECO 4590 IVECO 4590	SET1051 SET1091		SET1053 SET1026	
<b>330-25 AN [TAM], 330-26 H/HT [6X4]</b>					
	IVECO 5875 IVECO 5875 IVECO 5965/5975 IVECO 5965/5975 IVECO 4590 IVECO 4590	SET115 SET1080 SET1051 SET1091		SET1053 SET1026	
<b>330-30 H/HT/HCKD/HTCKD [6X4], 330-30 N</b>					
	IVECO 5875 IVECO 5875 IVECO 5965/5975 IVECO 5965/5975 IVECO 4590 IVECO 4590	SET115 SET1080 SET1051 SET1091		SET1053 SET1026	
<b>330-35 H/HCKD/HT [6X4]</b>					
	IVECO 5875 IVECO 5875 IVECO 5965/5975 IVECO 5965/5975	SET115 SET1080 SET1051 SET1091			

					
<b>IVECO</b>					
<b>330-35 H/HCKD/HT [6X4] ...</b>					
	IVECO 4590 IVECO 4590		SET1053 SET1026	I O	
<b>330-26 HW/HTW [6X6], 330-30 HW/NW/ANW [6X6]</b>					
	IVECO 5875 IVECO 5875 IVECO 5965/5975 IVECO 5965/5975 IVECO 4590 IVECO 4590	SET115 SET1080 SET1051 SET1091	SET1053 SET1026	I O I O I O	
<b>330-32 ANW [6X6], 330-35 HW/CKD [6X6]</b>					
	IVECO 5875 IVECO 5875 IVECO 5965/5975 IVECO 5965/5975 IVECO 4590 IVECO 4590	SET115 SET1080 SET1051 SET1091	SET1053 SET1026	I O I O I O	
<b>619 T 1P / N 1P CKD</b>					
	IVECO 5875 IVECO 5875 IVECO 4560 IVECO 4560	SET115 SET1080	SET1070 6581X/6535	I O I O	
<b>EUROCARGO 60 E10/E12/E14</b>					
	IVECO 5827 IVECO 5827 IVECO 4517 IVECO 4517	SET1199 SET1199	SET1293 SET1293	I O I O	
<b>EUROCARGO 65 E10/E12/E12 H/E14</b>					
	IVECO 5827 IVECO 5827 IVECO 5830 IVECO 5830 IVECO 4517 IVECO 4517 IVECO 4519 IVECO 4519	SET1199 SET1199 SET1031 SET1030	SET1293 SET1293 SET1100 SET1100	I O I O I O I O	
<b>EUROCARGO 75 E13 TECTOR</b>					
	IVECO 5827 IVECO 5827 IVECO 5833 IVECO 5833 IVECO 4517 IVECO 4517 IVECO 4521 IVECO 4521	SET1199 SET1199 SET1195 SET1199	SET1293 SET1293 SET1207 SET1207	I O I O I O I O	



A

















									
									
<b>IVECO</b>									
<b>EUROCARGO 75 E15 TECTOR</b>									
	IVECO 5827	SET1199							
	IVECO 5827	SET1199							
	IVECO 5833	JXC18439CA/439DA							
	IVECO 5833	SET1199							
	IVECO 4515			SET1293					
	IVECO 4515			SET1293					
	IVECO 4521			SET1207					
	IVECO 4521			SET1207					
<b>EUROCARGO 75 E17 TECTOR</b>									
	IVECO 5827	SET1199							
	IVECO 5827	SET1199							
	IVECO 5833	JXC18439CA/439DA							
	IVECO 5833	SET1199							
	IVECO 4515			SET1293					
	IVECO 4515			SET1293					
	IVECO 4521			SET1207					
	IVECO 4521			SET1207					
<b>EUROCARGO 75 E18 TECTOR</b>									
	IVECO 5827	SET1199							
	IVECO 5827	SET1199							
	IVECO 5833	SET1195							
	IVECO 5833	SET1199							
	IVECO 4517			SET1293					
	IVECO 4517			SET1293					
	IVECO 4521			SET1207					
	IVECO 4521			SET1207					
<b>EUROCARGO 75 E12/E14/E15</b>									
	IVECO 5827	SET1199							
	IVECO 5827	SET1199							
	IVECO 5833	SET1195							
	IVECO 5833	SET1199							
	IVECO 4517			SET1293					
	IVECO 4517			SET1293					
	IVECO 4521			SET1207					
	IVECO 4521			SET1207					
<b>EUROCARGO 80 E15/E18/E21</b>									
	IVECO 5833	SET1195							
	IVECO 5833	SET1199							
	IVECO 4521			SET1207					
	IVECO 4521			SET1207					
<b>EUROCARGO 85 E15/E18/E18 H</b>									
		SET1195							
		SET1199							
				SET1207					
				SET1207					

















				 			
<b>IVECO</b>							
<b>EUROCARGO 95 E15/E21 [4X4]</b>							
		SET1091 SET1048		SET1104 30215			
<b>EUROCARGO 95 E18</b>							
		SET1195 SET1199		SET1207 SET1207			
<b>EUROCARGO 100 E21</b>							
	IVECO 5833 IVECO 5833 IVECO 4517 IVECO 4517 IVECO 4521 IVECO 4521 ROCKWELL [F120-F125] ROCKWELL [F120-F125]	SET1195 SET1199		SET1293 SET1293 SET1207 SET1207 SET349 SET98			04/91-04/92 04/91-04/92
<b>EUROCARGO 100 E17/E18/E21 TECTOR</b>							
	IVECO 5833 IVECO 5833 IVECO 4521 IVECO 4521	SET1195 SET1199		SET1207 SET1207			
<b>EUROCARGO 120 E23</b>							
	IVECO 5842/5851 IVECO 5842/5851 ROCKWELL [H125-P130] ROCKWELL [H125-P130]	SET1201 SET1201		SET1286 SET325			
<b>EUROCARGO 120 E18/E22/E25/E28 [4X2]</b>							
	MERITOR MS08 MERITOR MS10-144			SET1263 SET1263			
<b>EUROCARGO 130 E15/E18/E23</b>							
	IVECO 5842/5851 IVECO 5842/5851 ROCKWELL [H125-P130] ROCKWELL [H125-P130]	SET1201 SET1201		SET1286 SET325			
<b>EUROCARGO 130 E18/E25 [4X2]</b>							
	MERITOR MS08 MERITOR MS10-144			SET1263 SET1263			
<b>EUROCARGO 130 E24</b>							
		SET1201 SET1201		SET1286 SET325			



# APPLICATION LISTINGS - TRUCK

A















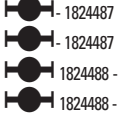

				 			
<b>IVECO</b>							
<b>EUROCARGO 135 E18/E23 [4X4]</b>							
		SET1051 SET1091		SET1026 SET1024			
<b>EUROCARGO 140 E18/E22/E25/E28 [4X2]</b>							
	MERITOR MS08 MERITOR MS10-144			SET1263 SET1263			
<b>EUROCARGO 150 E15/E18/E23/E27</b>							
	IVECO 5842/5851 IVECO 5842/5851 ROCKWELL [R130-S180] ROCKWELL [R130-S180]	SET1201 SET1201		SET1287 SET1286			
<b>EUROCARGO 150 E15 H/E18 H/E21 H/E23 H</b>							
		JXC25381CH/381DC SET1208		SET1026 SET1024			
<b>EUROCARGO 150 E22/E25/E28/E30 [4X2]</b>							
	MERITOR MS08 MERITOR MS10-144			SET1263 SET1263			
<b>EUROCARGO 160 E22/E25 [4X2]</b>							
	MERITOR MS10-164			SET1237			
<b>EUROCARGO 160 E28/E30 [4X2]</b>							
	MERITOR MS13-165			SET1242			
<b>EUROCARGO 170 E15/E18/E23/E27</b>							
		JXC25381CH/381DC SET1208		SET1287 SET1286			
<b>EUROCARGO 180 E21</b>							
	IVECO 5833 IVECO 5833 IVECO 4521 IVECO 4521	SET1195 SET1199		SET1207 SET1207			
<b>EUROCARGO 260 E23</b>							
	IVECO 5842/5851 IVECO 5842/5851 ROCKWELL [H125-P130] ROCKWELL [H125-P130]	SET1201 SET1201		SET1286 SET325			
<b>EUROCARGO 280 E23</b>							
	IVECO 5842/5851 IVECO 5842/5851 ROCKWELL [R130-S180] ROCKWELL [R130-S180]	SET1201 SET1201		SET1287 SET1286			

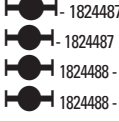
					
<b>IVECO</b>					
<b>EUROCARGO 320 E27</b>					
	IVECO 5842/5851 IVECO 5842/5851 IVECO 5842/5851 IVECO 5842/5851	SET1201 SET1201	SET1287 SET1286		
<b>EUROFIRE 95 E18 W</b>					
		SET1091 SET1048	30215		
<b>EUROFIRE 135 E22 W</b>					
		SET1091 SET1051	SET1026		
<b>EUROFIRE 135 E24</b>					
		SET1091 SET1051	SET1026		
<b>EUROFIRE 140 E24 TECTOR</b>					
		SET1091 SET1048	SET1026		
<b>EUROFIRE 140 E28</b>					
		SET1091 SET1051	SET1026		
<b>EUROTECH 180 E24/E30</b>					
		JXC25381CH/381DC SET1208	SET1287 SET1286		
<b>EUROTECH 180 E27/E34 MT</b>					
		JXC25381CH/381DC SET1208	SET1287 SET1286		
<b>EUROTECH 180 E34 MP</b>					
		JXC25381CH/381DC SET1208	SET1287 SET1286		
<b>EUROTECH 180 E38/E42</b>					
		JXC25381CH/381DC SET1208	SET1287 SET1286		Ch.173789- Ch.173789-



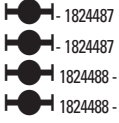























# APPLICATION LISTINGS - TRUCK

A

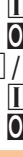
									
<b>IVECO</b>									
<b>EUROTECH 190 E24</b>									
		JXC25381CH/381DC SET1208		SET1070 SET1286 SET1070 SET1286			- 1824487 - 1824487 1824488 - 1824488 -		
<b>EUROTECH 190 E24 CURSOR</b>									
	MERITOR [MS17/U177E]	JXC25381CH/381DC SET1208		SET1242					
<b>EUROTECH 190 E27/E30</b>									
		JXC25381CH/381DC SET1208		SET1070 SET1286 SET1070 SET1286			- 1824487 - 1824487 1824488 - 1824488 -		
<b>EUROTECH 190 E30 MP</b>									
		JXC25381CH/381DC SET1208		SET1069 SET1068					
<b>EUROTECH 190 E31 CURSOR</b>									
	MERITOR [MS17/U177E]	JXC25381CH/381DC SET1208		SET1242					
<b>EUROTECH 190 E34</b>									
		JXC25381CH/381DC SET1208		SET1070 SET1286 SET1070 SET1286			- 1824487 - 1824487 1824488 - 1824488 -		
<b>EUROTECH 190 E35 CURSOR</b>									
	MERITOR [MS17/U177E]	JXC25381CH/381DC SET1208		SET1242 SET1053 SET1026			Exc. Ratio 3.79/1 Ratio 3.79/1 Ratio 3.79/1		
<b>EUROTECH 190 E38</b>									
		JXC25381CH/381DC SET1208							
<b>EUROTECH 190 E39/E43 CURSOR</b>									
	MERITOR [MS17/U177E]	JXC25381CH/381DC SET1208		SET1242					















































													
<b>IVECO</b>													
<b>EUROTECH 190 E42</b>													
			JXC25381CH/381DC SET1208		SET1070 SET1286 SET1070 SET1286			 - 1824487  - 1824487  1824488 -  1824488 -					
<b>EUROTECH 240 E30</b>													
		TRAILING AXLE TRAILING AXLE	JXC25381CH/381DC SET1208		SET1069 SET1068 JXC25381CH/381DC SET1208								
<b>EUROTECH 240 E 34</b>													
		TRAILING AXLE TRAILING AXLE	JXC25381CH/381DC SET1208		SET1287 SET1286 JXC25381CH/381DC SET1208								
<b>EUROTECH 260 E24/E31/E35 CURSOR</b>													
		MERITOR [MS17/U177E] TRAILING AXLE TRAILING AXLE TRAILING AXLE TRAILING AXLE	JXC25381CH/381DC SET1208		SET1242 JXC25381CH/381DC SET1208 SET1287 SET1286			   RI  RI					
<b>EUROTECH 260 E38/E42</b>													
			JXC25381CH/381DC SET1208		SET1287 SET1286								
<b>EUROTECH 260 E39/E43 CURSOR</b>													
		MERITOR [MS17/U177E] TRAILING AXLE TRAILING AXLE	JXC25381CH/381DC SET1208		SET1242 JXC25381CH/381DC SET1208								
<b>EUROTECH 325 E27</b>													
			JXC25381CH/381DC SET1208		SET1287 SET1286								
<b>EUROTECH 350/480 HP [1998]</b>													
		MERITOR MS13-175			SET1242								



# APPLICATION LISTINGS - TRUCK

A













						
<b>IVECO</b>						
<b>EUROTECH 400 E30/E34 MP/E34 MT</b>						
		JXC25381CH/381DC SET1208	SET1287 SET1286			
<b>EUROTECH 400 E38</b>						
		JXC25381CH/381DC SET1208	SET1287 SET1286			Ch.173789- Ch.173789-
<b>EUROTECH 400 E42</b>						
		JXC25381CH/381DC SET1208	SET1287 SET1286			
<b>EUROTECH 440 E31/E35 CURSOR</b>						
	MERITOR MS17 [U177E]	JXC25381CH/381DC SET1208	SET1242			
<b>EUROTECH 440 E34 MP</b>						
		JXC25381CH/381DC SET1208	SET1070 SET1286 SET1070 SET1286			 - 1824487  - 1824487  1824488 -  1824488 -
<b>EUROTECH 440 E38 MP</b>						
	TRAILING AXLE TRAILING AXLE	JXC25381CH/381DC SET1208	SET1287 SET1286 SET1069 SET1068 SET1070 SET1286 SET1070 SET1286 JXC25381CH/381DC SET1208			-Ch.173788  -Ch.173789,  - 1824487 -Ch.173789,  - 1824487 -Ch.173789,  1824488 - -Ch.173789,  1824488 -
<b>EUROTECH 440 E39/E43 CURSOR</b>						
	MERITOR [MS17/U177E]	JXC25381CH/381DC SET1208	SET1242			
<b>EUROTECH 440 E42 [4X2]</b>						
		JXC25381CH/381DC SET1208	SET1070 SET1286			 - 1824487  - 1824487







				 			
<b>IVECO</b>							
<b>EUROTECH 440 E42 [4X2] ...</b>							
				SET1070 SET1286		 1824488 -  1824488 -	
<b>EUROTECH 440 E42 [6X2]</b>							
		JXC25381CH/381DC SET1208		SET1287 SET1286 SET1070 SET1286 SET1070 SET1286 JXC25381CH/381DC SET1208		-Ch.173788 -Ch.173788 -Ch.173789,  - 1824487 -Ch.173789,  - 1824487 -Ch.173789,  - 1824488 - -Ch.173789,  - 1824488 -	TRAILING AXLE TRAILING AXLE
<b>EUROTECH 440 E42 [6X4]</b>							
		JXC25381CH/381DC SET1208		SET1287 SET1286			
<b>EUROTRAKKER 180 E25 [4X4]</b>							
		SET1051 SET1091		SET1053 SET1026			
<b>EUROTRAKKER 190 E30/190 E31 [4X2]</b>							
		JXC25381CH/381DC SET1208		SET1053 SET1026			
<b>EUROTRAKKER 190 E31 [4X4]</b>							
		SET1051 SET1091		SET1053 SET1026			
<b>EUROTRAKKER 190 E34</b>							
		JXC25381CH/381DC SET1208		SET1053 SET1026			
<b>EUROTRAKKER 190 E35/E38/E44 CURSOR</b>							
		JXC25381CH/381DC SET1208		SET1053 SET1026			



# APPLICATION LISTINGS - TRUCK















A













				 			
<b>IVECO</b>							
<b>EUROTRAKKER 190 E37</b>							
		JXC25381CH/381DC SET1208	SET1053 SET1026				
<b>EUROTRAKKER 260 E30/E34 [6X4]</b>							
		JXC25381CH/381DC SET1208	SET1053 SET1026 SET1053 SET1026		Ratio 4.23/1 Ratio 4.23/1 Exc. Ratio 4.23/1 Exc. Ratio 4.23/1		
<b>EUROTRAKKER 260 E31/E35 CURSOR</b>							
		JXC25381CH/381DC SET1208	SET1053 SET1026				
<b>EUROTRAKKER 260 E38/E44/E48 CURSOR</b>							
	FORWARD REAR FORWARD REAR REAR REAR	JXC25381CH/381DC SET1208	SET1053 SET1026 SET1053 SET1026				
<b>EUROTRAKKER 260 E37 [6X4]</b>							
	FORWARD REAR FORWARD REAR REAR REAR REAR REAR REAR REAR REAR REAR	JXC25381CH/381DC SET1208	SET1053 SET1026 SET1053 SET1026 SET1053 SET1026		Ratio 4.23/1 Ratio 4.23/1 Exc. Ratio 4.23/1 Exc. Ratio 4.23/1		
<b>EUROTRAKKER 260 E42/E47 [6X4]</b>							
	FORWARD REAR FORWARD REAR REAR REAR REAR REAR	JXC25381CH/381DC SET1208	SET1053 SET1026 SET1053 SET1026				
<b>EUROTRAKKER 260 E42 [6X6]</b>							
	FORWARD REAR FORWARD REAR REAR REAR REAR REAR	SET1051 SET1091	SET1053 SET1026 SET1053 SET1026				

													
<b>IVECO</b>													
<b>EUROTRAKKER 330 E34/E37 [6X4]</b>													
	IVECO 5875 IVECO 5875 IVECO 5965/5975 IVECO 5965/5975  IVECO 4590 IVECO 4590	JXC25381CH/381DC SET1208 SET115 SET1080 SET1051 SET1091		SET1053 SET1026 SET1053 SET1026		I O I O I O I O I O							
<b>EUROTRAKKER 340 E34/E37/E42 [8X4]</b>													
	FORWARD FRONT FORWARD FRONT REAR FRONT REAR FRONT FORWARD REAR FORWARD REAR REAR REAR REAR REAR	JXC25381CH/381DC SET1208 JXC25381CH/381DC SET1208		SET1053 SET1026 SET1053 SET1026		I O I O I O I O							
<b>EUROTRAKKER 340 E35/E38/E44 CURSOR</b>													
	FORWARD REAR FORWARD REAR REAR REAR	JXC25381CH/381DC SET1208		SET1053 SET1026 SET1053 SET1026		I O I O I O							
<b>EUROTRAKKER 340 E42 [6X6]</b>													
	FORWARD REAR FORWARD REAR REAR REAR REAR REAR	SET1051 SET1091		SET1053 SET1026 SET1053 SET1026		I O I O I O							
<b>EUROTRAKKER 380 E31/E37/E42/E47 [6X4]</b>													
	FORWARD REAR FORWARD REAR REAR REAR REAR REAR	JXC25381CH/381DC SET1208		SET1053 SET1026 SET1053 SET1026		I O I O I O							
<b>EUROTRAKKER 380 E31/E37/E42 [6X6]</b>													
	FORWARD REAR FORWARD REAR REAR REAR REAR REAR	SET1051 SET1091		SET1053 SET1026 SET1053 SET1026		I O I O I O							



























A

											
<b>IVECO</b>											
<b>EUROTRAKKER 380 E34/E42 [6X4]</b>											
				JXC25381CH/381DC SET1208		SET1053 SET1026					
<b>EUROTRAKKER 380 E35/E38/E44/E48 CURSOR</b>											
				JXC25381CH/381DC SET1208		SET1053 SET1026 SET1053 SET1026					
		FORWARD REAR FORWARD REAR REAR REAR									
<b>EUROTRAKKER 400 E31/E34/E37/E42 [4X2]</b>											
				JXC25381CH/381DC SET1208		SET1053 SET1026					
<b>EUROTRAKKER 400 E31/E37 [4X4]</b>											
				SET1051 SET1091		SET1053 SET1026					
<b>EUROTRAKKER 400 E35/E38/E44 CURSOR</b>											
				JXC25381CH/381DC SET1208		SET1053 SET1026					
<b>EUROTRAKKER 410 E35 [6X4] CURSOR</b>											
				JXC25381CH/381DC SET1208		SET1053 SET1026 SET1053 SET1026					
		FORWARD REAR FORWARD REAR REAR REAR									
<b>EUROTRAKKER 410 E37/E42 [8X4]</b>											
				JXC25381CH/381DC SET1208 JXC25381CH/381DC SET1208		SET1053 SET1026 SET1053 SET1026					
		FORWARD FRONT FORWARD FRONT REAR FRONT REAR FRONT FORWARD REAR FORWARD REAR REAR REAR REAR REAR									
<b>EUROTRAKKER 410 E38/E44/E48 CURSOR</b>											
				JXC25381CH/381DC SET1208		SET1053 SET1026					
		FORWARD REAR FORWARD REAR									



















					
<b>IVECO</b>					
<b>EUROTRAKKER 410 E38/E44/E48 CURSOR ...</b>					
	REAR REAR		SET1053 SET1026		
<b>EUROTRAKKER 410 E42 [6X6]</b>					
	FORWARD REAR FORWARD REAR REAR REAR REAR REAR	SET1051 SET1091	SET1053 SET1026 SET1053 SET1026		
<b>EUROTRAKKER 440 E34/E42 [6X4]</b>					
	FORWARD REAR FORWARD REAR REAR REAR REAR REAR	JXC25381CH/381DC SET1208	SET1053 SET1026 SET1053 SET1026		
<b>EUROTRAKKER 440 E37 HT</b>					
	FORWARD REAR FORWARD REAR REAR REAR REAR REAR REAR REAR REAR REAR	JXC25381CH/381DC SET1208	SET1053 SET1026 SET1053 SET1026 SET1053 SET1026		Exc. Ratio 3.79/1 Exc. Ratio 3.79/1 Ratio 3.79/1 Ratio 3.79/1
<b>EUROTRAKKER 440 E38/E44 CURSOR</b>					
	FORWARD REAR FORWARD REAR REAR REAR REAR REAR	JXC25381CH/381DC SET1208	SET1053 SET1026 SET1053 SET1026		
<b>EUROTRAKKER 720 E31/E37/E42/E47 [6X4]</b>					
	FORWARD REAR FORWARD REAR REAR REAR REAR REAR	JXC25381CH/381DC SET1208	SET1053 SET1026 SET1053 SET1026		
<b>EUROTRAKKER 720 E31/E37/E42 [6X6]</b>					
	FORWARD REAR FORWARD REAR REAR REAR REAR REAR	SET1051 SET1091	SET1053 SET1026 SET1053 SET1026		



A

									
<b>IVECO</b>									
<b>EUROTRAKKER 720 E44/E48 CURSOR</b>									
	FORWARD REAR FORWARD REAR REAR REAR REAR REAR	JXC25381CH/381DC SET1208	SET1053 SET1026 SET1053 SET1026						
<b>EUROSTAR 180 E38/E42</b>									
		JXC25381CH/381DC SET1208	SET1287 SET1286						
<b>EUROSTAR 190 E38</b>									
		JXC25381CH/381DC SET1208	SET1069 SET1068 SET1070 SET1286 SET1070 SET1286		-Ch.173788 -Ch.173788 -Ch.173789,  1824487 -Ch.173789,  1824487 -Ch.173789,  1824488 - -Ch.173789,  1824488 -				
<b>EUROSTAR 190 E42</b>									
		JXC25381CH/381DC SET1208	SET1070 SET1286 SET1070 SET1286		-Ch.173789,  1824487 -Ch.173789,  1824487 -Ch.173789,  1824488 - -Ch.173789,  1824488 -				
<b>EUROSTAR 190 E39/E43 CURSOR</b>									
	MERITOR [MS17/U177E]	JXC25381CH/381DC SET1208	SET1242						
<b>EUROSTAR 190 E47/E52</b>									
		JXC25381CH/381DC SET1208	SET1070 SET1286 SET1070 SET1286		-Ch.173789,  1824487 -Ch.173789,  1824487 -Ch.173789,  1824488 - -Ch.173789,  1824488 -				
<b>EUROSTAR 240 E38</b>									
	TRAILING AXLE TRAILING AXLE	JXC25381CH/381DC SET1208	SET1069 SET1068 SET1287 SET1286 JXC25381CH/381DC SET1208		-Ch.173788 -Ch.173788 Ch.173789- Ch.173789-				



















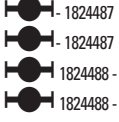









				 			
<b>IVECO</b>							
<b>EUROSTAR 240 E42/E47/E52</b>							
	TRAILING AXLE TRAILING AXLE TRAILING AXLE TRAILING AXLE	JXC25381CH/381DC SET1208	SET1287 SET1286 SET1070 SET1286 SET1070 SET1286 JXC25381CH/381DC SET1208 SET1287 SET1286		ID = 95mm ID = 95mm ID = 105mm,  - 1824487 ID = 105mm,  - 1824487 ID = 105mm,  1824488 - ID = 105mm,  1824488 -	OE 7177196 OE 7177196 OE 7177168 OE 7177168	
<b>EUROSTAR 260 E39/E43 CURSOR</b>							
	MERITOR [MS17/U177E] TRAILING AXLE TRAILING AXLE	JXC25381CH/381DC SET1208	SET1242 JXC25381CH/381DC SET1208				
<b>EUROSTAR 260 E42/E47/E52</b>							
		JXC25381CH/381DC SET1208	SET1287 SET1286				
<b>EUROSTAR 350/480 HP [1998]</b>							
	MERITOR MS13-175		SET1242				
<b>EUROSTAR 400 E38</b>							
		JXC25381CH/381DC SET1208	SET1287 SET1286 SET1069 SET1068		ID = 95mm ID = 95mm		
<b>EUROSTAR 400 E42/E47/E52</b>							
		JXC25381CH/381DC SET1208	SET1287 SET1286				
<b>EUROSTAR 440 E38</b>							
		JXC25381CH/381DC SET1208	SET1069 SET1068 SET1070 SET1286 SET1070 SET1286		-Ch.173788 -Ch.173789,  1824488 - -Ch.173789,  1824488 -		



# APPLICATION LISTINGS - TRUCK















A







						
<b>IVECO</b>						
<b>EUROSTAR 440 E42/E47/E52 [4X2]</b>						
		JXC25381CH/381DC SET1208	SET1070 SET1286 SET1070 SET1286			 - 1824487 - 1824487 1824488 - 1824488 -
<b>EUROSTAR 440 E42/E52 [6X4]</b>						
		JXC25381CH/381DC SET1208	SET1287 SET1286			
<b>EUROSTAR 440 E43/E46/E48 CURSOR</b>						
	MERITOR [MS17/U177E]	JXC25381CH/381DC SET1208	SET1242			
<b>STRALIS 190 S31/S33/S36/S42 [4X2] CURSOR</b>						
	MERITOR MS13-175		SET1242			
<b>STRALIS 190 S45/S50 [4X2] CURSOR</b>						
	MERITOR MS13-175		SET1242			
<b>STRALIS 260 S31/S33/S36/S42/S45 [4X2] CURSOR</b>						
	MERITOR MS13-175		SET1242			
<b>STRALIS 260 S40/S43/S44/S48/S54</b>						
	MERITOR [MS17/U177E] TRAILING AXLE TRAILING AXLE	JXC25381CH/381DC SET1208	SET1242 JXC25381CH/381DC SET1208			
<b>STRALIS 260 S50/S56 [4X2] CURSOR</b>						
	MERITOR MS13-175		SET1242			
<b>STRALIS 440 S36/S42/S45/S50/S56 CURSOR [4X2]</b>						
	MERITOR MS13-175		SET1242			
<b>STRALIS 440 S40/S43/S44/S48/S54</b>						
	FORWARD FRONT FORWARD FRONT REAR FRONT REAR FRONT MERITOR [MS17/U177E]	JXC25381CH/381DC SET1208 JXC25381CH/381DC SET1208	SET1242			
<b>TRAKKER [6X4]</b>						
	MERITOR MS15		SET1242			
<b>TURBOSTAR 190-36</b>						
	IVECO 5875 IVECO 5875	SET115 SET1080				

													
<b>IVECO</b>													
<b>TURBOSTAR 190-36 ...</b>													
	ROCKWELL U SERIES						SET1070				I		
	ROCKWELL U SERIES						SET1286				O		
<b>TURBOSTAR 190-38 HP</b>													
	IVECO 5875		SET115								I		
	IVECO 5875		SET1080								O		
	ROCKWELL U SERIES						SET1070				I		
	ROCKWELL U SERIES						SET1286				O		
<b>TURBOSTAR 190-42/190-48</b>													
	IVECO 5875		SET115								I		
	IVECO 5875		SET1080								O		
	ROCKWELL U SERIES						SET1070				I		
	ROCKWELL U SERIES						SET1286				O		
<b>TURBOSTAR 240-36</b>													
	IVECO 5875		SET115								I		
	IVECO 5875		SET1080								O		
	ROCKWELL [U180E]						SET1070				I		
	ROCKWELL [U180E]						SET1286				O		
<b>TURBOSTAR 240-36 GV</b>													
	IVECO 5875		SET115								I		
	IVECO 5875		SET1080								O		
	ROCKWELL U SERIES						SET1070				I		
	ROCKWELL U SERIES						SET1286				O		
	TRAILING AXLE						SET115				I		
	TRAILING AXLE						SET1080				O		
<b>TURBOSTAR 240-38 GV</b>													
	IVECO 5875		SET115								I		
	IVECO 5875		SET1080								O		
	ROCKWELL U SERIES						SET1070				I		
	ROCKWELL U SERIES						SET1286				O		
	TRAILING AXLE						SET115				I		
	TRAILING AXLE						SET1080				O		
<b>TURBOSTAR 240-42</b>													
	IVECO 5875		SET115								I		
	IVECO 5875		SET1080								O		
	ROCKWELL [U180E]						SET1070				I		
	ROCKWELL [U180E]						SET1286				O		
<b>TURBOSTAR 240-48</b>													
	IVECO 5875		SET115								I		
	IVECO 5875		SET1080								O		
	ROCKWELL U SERIES						SET1070				I		
	ROCKWELL U SERIES						SET1286				O		
	TRAILING AXLE						SET115				I		
	TRAILING AXLE						SET1080				O		
<b>TURBOSTAR 260-36/260-38/260-48</b>													
	IVECO 5875		SET115								I		
	IVECO 5875		SET1080								O		



A

















							
<b>IVECO</b>							
<b>TURBOSTAR 260-36/260-38/260-48 ...</b>							
	ROCKWELL U SERIES ROCKWELL U SERIES ROCKWELL [R130-S180] ROCKWELL [R130-S180] CALABRESE CALABRESE		SET1070 SET1286 SET1287 SET1286 SET1104 SET1113				
<b>TURBOSTAR 260-36/260-42</b>							
	IVECO 5875 IVECO 5875 ROCKWELL [U180E] ROCKWELL [U180E]	SET115 SET1080	SET1070 SET1286				
<b>TURBOTECH 190-24 T.R.U.</b>							
	IVECO 5875 IVECO 5875 ROCKWELL U180E ROCKWELL U180E	SET115 SET1080	SET1070 SET1286				-06/88 -06/88
<b>TURBOTECH 190-26</b>							
	IVECO 5875 IVECO 5875 IVECO 4590 IVECO 4590 ROCKWELL U SERIES ROCKWELL U SERIES	SET115 SET1080	SET1053 SET1026 SET1070 SET1286				
<b>TURBOTECH 190-30</b>							
	IVECO 5875 IVECO 5875 IVECO 4590 IVECO 4590	SET115 SET1080	SET1053 SET1026				
<b>TURBOTECH 190-32 GV</b>							
	IVECO 5875 IVECO 5875 ROCKWELL U SERIES ROCKWELL U SERIES	SET115 SET1080	SET1070 SET1286				
<b>TURBOTECH 190-36 GV</b>							
	IVECO 5875 IVECO 5875 ROCKWELL U SERIES ROCKWELL U SERIES	SET115 SET1080	SET1070 SET1286				
<b>TURBOTECH 190-38</b>							
	IVECO 5875 IVECO 5875 ROCKWELL U SERIES ROCKWELL U SERIES	SET115 SET1080	SET1070 SET1286				
<b>TURBOTECH 220-32 T.R.U.</b>							
	IVECO 5875 IVECO 5875	SET115 SET1080					















				 			
<b>IVECO</b>							
<b>TURBOTECH 220-32 T.R.U. ...</b>							
	ROCKWELL U SERIES ROCKWELL U SERIES TRAILING AXLE TRAILING AXLE		SET1070 SET1286 SET115 SET1080			I O I O	
<b>TURBOTECH 220-36 GV</b>							
	IVECO 5875 IVECO 5875 ROCKWELL U SERIES ROCKWELL U SERIES TRAILING AXLE TRAILING AXLE	SET115 SET1080	SET1070 SET1286 SET115 SET1080			I O I O I O	
<b>TURBOTECH 220-38 GV</b>							
	IVECO 5875 IVECO 5875 ROCKWELL U SERIES ROCKWELL U SERIES TRAILING AXLE TRAILING AXLE	SET115 SET1080	SET1070 SET1286 SET115 SET1080			I O I O I O	
<b>TURBOTECH 240-26</b>							
	IVECO 5875 IVECO 5875 ROCKWELL U SERIES ROCKWELL U SERIES TRAILING AXLE TRAILING AXLE	SET115 SET1080	SET1070 SET1286 SET115 SET1080			I O I O I O	
<b>TURBOTECH 240-32 GV</b>							
	IVECO 5875 IVECO 5875 ROCKWELL U SERIES ROCKWELL U SERIES TRAILING AXLE TRAILING AXLE	SET115 SET1080	SET1070 SET1286 SET115 SET1080			I O I O I O	
<b>TURBOTECH 240-36 GV</b>							
	IVECO 5875 IVECO 5875 ROCKWELL U SERIES ROCKWELL U SERIES TRAILING AXLE TRAILING AXLE	SET115 SET1080	SET1070 SET1286 SET115 SET1080			I O I O I O	
<b>TURBOTECH 240-38 GV</b>							
	IVECO 5875 IVECO 5875 ROCKWELL U SERIES ROCKWELL U SERIES TRAILING AXLE TRAILING AXLE	SET115 SET1080	SET1070 SET1286 SET115 SET1080			I O I O I O	



# APPLICATION LISTINGS - TRUCK

















A

					
<b>IVECO</b>					
<b>TURBOTECH 260-32/260-36/260-38</b>					
	IVECO 5875 IVECO 5875 ROCKWELL U SERIES ROCKWELL U SERIES ROCKWELL [R130-S180] ROCKWELL [R130-S180] CALABRESE CALABRESE	SET115 SET1080	SET1070 SET1286 SET1287 SET1286 SET1104 SET1113		
<b>TURBOTECH 260-36/260-42</b>					
	IVECO 5875 IVECO 5875 ROCKWELL [U180E] ROCKWELL [U180E]	SET115 SET1080	SET1070 SET1286		
<b>TURBOZETA 60-11</b>					
		SET1031 SET1030	SET1044 SET1044		
<b>TURBOZETA 79-12</b>					
		SET1031 SET1030	SET1100 SET1100		
<b>ZETA 50-9/10</b>					
		SET1031 SET1030	SET1044 SET1044		
<b>ZETA 70-14</b>					
		SET1031 SET1030	SET1100 SET1100		
<b>ZETA 95-14</b>					
	ROCKWELL [125E] ROCKWELL [125E]	SET1031 SET1030	SET349 SET98		
<b>ZETA 109-14</b>					
	ROCKWELL [H140E] ROCKWELL [H140E]	SET1031 SET1030	SET1286 SET325		 















				 			
<b>IVECO</b>							
<b>Z RANGE 50-8</b>							
		SET1031 SET1030		SET1044 SET1044			
<b>Z RANGE 60-10/65-10/75-10/79-10/79-14</b>							
		SET1031 SET1030		SET1100 SET1100			
<b>Z 220 STRIPPED CHASS./Z 220 T H</b>							
		SET1031 SET1030		SET1100 SET1100			
<b>LEYLAND</b>							
<b>BISON</b>							
	6.5T, ALFORD & ALDER 6.5T, ALFORD & ALDER ALBION RA 1069/70 ALBION RA 1069/70 ALBION RA 1000 ALBION RA 1000	SET1146 SET210		SET414 SET113 SET401 748S/742			1978- 1978- -1978 -1978
<b>BOXER SERIES-BX 18 TF / BX 19 TA / BX 20 TF</b>							
	3.5T 3.5T BMC 1&2 SPEED, EATON CENTRE BMC 1&2 SPEED, EATON CENTRE	SET278 SET1119		SET216 SET1137			
<b>BOXER SERIES 1000</b>							
	3.5T 3.5T BMC 1&2 SPEED, EATON CENTRE BMC 1&2 SPEED, EATON CENTRE BMC 1&2 SPEED BMC 1&2 SPEED	SET278 SET1119		SET216 SET1137 567X/563 SET103			
<b>BOXER SERIES 1200/1300</b>							
	3.5T 3.5T BMC 1&2 SPEED, EATON CENTRE BMC 1&2 SPEED, EATON CENTRE	SET278 SET1119		SET216 SET1137			
<b>BOXER SERIES 1425</b>							
	6.5T, ALFORD & ALDER 6.5T, ALFORD & ALDER MAUDSLAY, 10T, 1&2 SPEED MAUDSLAY, 10T, 1&2 SPEED	SET1146 SET210		SET216 SET1137			



A





















				 			
<b>LEYLAND</b>							
<b>BUFFALO SERIES</b>							
	6.5T, ALFORD & ALDER 6.5T, ALFORD & ALDER ALBION, RA 1000 ALBION, RA 1000 GUY GUY	SET1146 SET210		SET1137 748S/742 SET289 SET403			
<b>CLYDESDALE 2 CD RIGID</b>							
	6.5T, ALFORD & ALDER 6.5T, ALFORD & ALDER ALBION RA 1000 ALBION RA 1000 ALBION RA 1065 ALBION RA 1065-	SET1146 SET210		SET929 748S/742 SET414 SET113			1972-1978 1972-1978 1978 - 1978 -
<b>CLYDESDALE 2 CD TRACTOR</b>							
	5.35T, ALFORD & ALDER 5.35T, ALFORD & ALDER ALBION RA 1000 ALBION RA 1000 ALBION RA 1065 ALBION RA 1065	HM212044/HM212011 SET102		SET929 748S/742 SET414 SET113			1972-1978 1972-1978 1978 - 1978 -
<b>CONSTRUCTOR SERIES 6</b>							
	2415, 2417, 2420, 2421 2415, 2417, 2420, 2421 2421 2421 2415, 2417, 2420 2415, 2417, 2420 2415, 2417, 2420, 2421 2415, 2417, 2420, 2421 2415, 2417, 2420, 2421, ALBION AXLE 2415, 2417, 2420, 2421, ALBION AXLE	SET1146 SET210 HM212044/HM212011 SET1109 H212749/H212710 SET1109		598X/592A 748S/742 SET401 748S/742			04/84 - 04/84 -
<b>CONSTRUCTOR SERIES 8</b>							
	3021, 3023, 3025, 3026 3021, 3023, 3025, 3026 3021, 3023, 3025, 3026 3021, 3023, 3025, 3026	H212749/H212710 SET1109		SET414 SET113			
<b>CRUISER 1615 +</b>							
	6.5T, ALFORD & ALDER 6.5T, ALFORD & ALDER 6.5T, ALFORD & ALDER 6.5T, ALFORD & ALDER	SET1146 SET210 H212749/H212710 SET1109					
<b>CRUISER 1621</b>							
	6.5T, ALFORD & ALDER 6.5T, ALFORD & ALDER CAM BRAKES CAM BRAKES GUY GUY	SET1146 SET210		598X/592A 748S/742 SET289 SET403			 









				 			
<b>LEYLAND</b>							
<b>CRUISER 1623</b>							
	6.5T, ALFORD & ALDER 6.5T, ALFORD & ALDER 6.5T, ALFORD & ALDER 6.5T, ALFORD & ALDER	SET1146 SET210		SET317 SET317			
<b>CRUSADER SERIES [SCAMMELL]</b>							
	6.5T, ALFORD & ALDER 6.5T, ALFORD & ALDER 4X2, LEYLAND 4X2, LEYLAND 6X4 MAUDSLAY, 10T 6X4 MAUDSLAY, 10T	SET1146 SET210		SET109 SET109 SET216 SET216			
<b>FREIGHTER SERIES 1111/1114</b>							
		SET278 SET1119		SET325 SET1178			
<b>FREIGHTER SERIES 1311/1314/1411/1414</b>							
		SET278 SET1119		SET216 SET1137			
<b>FREIGHTER SERIES 1511</b>							
		HM212044/HM212011 SET102 HM212044/HM212011 SET1058		SET216 SET1137 SET414 SET113			Roller Cam Brakes Roller Cam Brakes Roller Cam Brakes Roller Cam Brakes
<b>FREIGHTER SERIES 1514</b>							
		HM212044/HM212011 SET1109		SET216 SET1137 SET414 SET113			Roller Cam Brakes Roller Cam Brakes Roller Cam Brakes Roller Cam Brakes
<b>FREIGHTER SERIES 1613/1614/1615</b>							
		SET1146 SET210 HM212044/HM212011 SET1109		SET414 SET113			Roller Cam Brakes Roller Cam Brakes Roller Cam Brakes Roller Cam Brakes









A























				 			
<b>LEYLAND</b>							
<b>HANDYMAN SERIES [SCAMMELL]</b>							
	6.5T, ALFORD & ALDER 6.5T, ALFORD & ALDER ALBION RA 1065 ALBION RA 1065	SET1146 SET210		SET414 SET113			
<b>LYNX SERIES 2LX/3LX/4LX TRACTOR</b>							
	5.35T, ALFORD & ALDER 5.35T, ALFORD & ALDER GUY GUY	HM212044/HM212011 SET102		SET289 SET403			 
<b>LYNX SERIES 2LX/3LX/4LX RIGID</b>							
	6.5T, ALFORD & ALDER 6.5T, ALFORD & ALDER ALBION RA 1065 ALBION RA 1065	SET1146 SET210		SET414 SET113			
<b>MARATHON SERIES TRACTOR [34T/38T]</b>							
	6.5T, ALFORD & ALDER 6.5T, ALFORD & ALDER GUY GUY 4X2 LEYLAND 4X2 LEYLAND	SET1146 SET210		SET289 SET403 SET109 SET109			   
<b>REIVER SERIES 2RE</b>							
	6.5T, ALFORD & ALDER 6.5T, ALFORD & ALDER ALBION RA 1000 ALBION RA 1000	SET1146 SET210		SET1137 748S/742			
<b>REIVER SERIES RE 29/RE 31</b>							
		558/552A SET210		SET1137 748S/742			
<b>RELIANCE SERIES</b>							
	LEYLAND LEYLAND 6.5T, ALFORD & ALDER 6.5T, ALFORD & ALDER LEYLAND	SET110 615/612 SET1146 SET210		SET216			
<b>ROADTRAIN</b>							
	6.5T, ALFORD & ALDER 6.5T, ALFORD & ALDER LEYLAND, 13T LEYLAND, 13T LEYLAND RATIONALISED, 17T LEYLAND RATIONALISED, 17T LEYLAND, 10T LEYLAND, 10T	SET1146 SET210		SET109 SET109 SET317 SET317 H212749/H212710 SET1109			

											
<b>LEYLAND</b>											
<b>ROUTEMAN SERIES [SCAMMELL]</b>											
	6.5T, ALFORD & ALDER 6.5T, ALFORD & ALDER 5T, ALFORD & ALDER 5T, ALFORD & ALDER ALBION RA 1069/70 ALBION RA 1069/70	SET1146 SET210 HM212044/HM212011 SET102		SET414 SET113							
<b>TRUNKER SERIES [SCAMMELL]</b>											
	LEYLAND LEYLAND 6.5T, ALFORD & ALDER 6.5T, ALFORD & ALDER	558/552A SET210 SET1146 SET210		SET109 SET109						3 3	
<b>MAN</b>											
<b>6/8T [4X2]-F SERIES L01</b>											
	V7-36 L V7-36 L W 6.1T W 6.8T	EK50024 32207		SET408 SET408							
<b>8/9T [4X2]-FOC SERIES L05</b>											
	V7-36 L V7-36 L W 6.1T W 6.8T	EK50024 32207		SET408 SET408							
<b>10T [4X2]-F SERIES L04</b>											
	V7-36 L V7-36 L W 6.8T	EK50024 32207		SET408							
<b>12T [4X4]-FA SERIES M07</b>											
	VA7-0540 VA7-0540 HY-0955 HY-0955 H7-0870 H7-0870	SET1047 SET1045		SET1024 SET1101 SET1048 SET1064							
<b>12/13T [4X2]-F SERIES M01</b>											
	V7-42 L V7-52 L HY-0955 HY-0955 HY-1175 HY-1175	32208 SET1109		SET1024 SET1101 SET1024 SET1101							

















A































									
									
<b>MAN</b>									
<b>12/13T [4X2]-FL SERIES M02</b>									
	V7-42 L V7-52 L HY-0955 HY-0955 HY-1175 HY-1175	32208 SET1109		SET1024 SET1101 SET1024 SET1101					
<b>14/15 T [4X2]-F SERIES M03</b>									
	V7-52 L HY-0955 HY-0955 HY-1175 HY-1175	SET1109		SET1024 SET1101 SET1024 SET1101					
<b>14/15T [4X2]-FL SERIES M04</b>									
	V7-52 L HY-0955 HY-0955 HY-1175 HY-1175	SET1109		SET1024 SET1101 SET1024 SET1101					
<b>16/19T [4X2]-F SERIES F01</b>									
	V9-75 L V9-75 L HY-13110 HY-13110 H9-16120 H9-13120 H9-13120 H9-13120 H9-10120 H9-10120	SET1300 SET1079		SET1306 SET1091 SET1094 SET1094 SET1094 SET1025 SET1093 SET1049				07/90 - 06/86-07/90 06/86-07/90	
<b>16/19T [4X2]-FL SERIES F02</b>									
	V9-75 L V9-75 L H9-10120 H9-10120 HY-13110 HY-13110 H9-13120 H9-13120	SET1300 SET1079		SET1093 SET1049 SET1306 SET1091 SET1094 SET1025					
<b>16/19T [4X2]-FLL SERIES F03</b>									
	V9-65 L V9-65 L V9-75 L V9-75 L HY-13110 HY-13110 H9-13120 H9-13120	SET1300 SET1079 SET1300 SET1079		SET1306 SET1091 SET1094 SET1025					

					
<b>MAN</b>					
<b>16/19T [4X2]-U SERIES U01</b>					
	V9-75 L V9-75 L H9-10120 H9-10120 H9-13120 H9-13120 HY-13110 HY-13110	SET1300 SET1079	SET1093 SET1049 SET1094 SET1025 SET1306 SET1091		
<b>17/18T [4X2]-FL SERIES M06</b>					
	VF-65 L VF-80 L VF-80 L HY-0955 HY-0955 HY-1175 HY-1175 H7-1080 H7-1080 H7-1080 H7-1080 H7-1180 H7-1180 H7-1180 H7-1180	SET1078 SET1300 SET1079	SET1024 SET1101 SET1306 SET1091 SET1306 SET1049 SET1306 SET1049 SET1306 SET1049 SET1306 SET1049		01/90 - 01/90 -        
<b>19T [4X2]-F SERIES F21</b>					
	V9-75 L V9-75 L HY-13110 HY-13110 H9-13120 H9-13120	SET1300 SET1079	SET1306 SET1091 SET1094 SET1025		
<b>19T [4X2]-FL SERIES F22</b>					
	V9-75 L V9-75 L HY-13110 HY-13110 H9-13120 H9-13120	SET1300 SET1079	SET1306 SET1091 SET1094 SET1025		
<b>19T [4X4]-FA SERIES F04</b>					
	VA9-0950 VA9-0950 H9-13120 H9-13120 H9-13120 H9-13120 H9-16120	XGA32021X SET1049	SET1094 SET1025 SET1094 SET1025 SET1094		   



A





















































				 			
<b>MAN</b>							
<b>22/24/25/26T [6X2]-FNL SERIES F25</b>							
	V9-75 L V9-75 L HN9-75 HN9-75 H9-13120 H9-13120 H9-13120 H9-13120 HY-13110 HY-13110	SET1300 SET1079		SET1300 SET1079 SET1094 SET1025 SET1094 SET1025 SET1306 SET1091			
<b>22/24/25/26T [6X2]-FNLL SERIES F06</b>							
	V9-75 L V9-75 L HN9-75 HN9-75 HY-13110 HY-13110 H9-13120 H9-13120 H9-13120 H9-13120	SET1300 SET1079		SET1300 SET1079 SET1306 SET1091 SET1094 SET1025 SET1094 SET1025			
<b>22/24/25/26T [6X2]-FVL SERIES F07</b>							
	V9-75 L V9-75 L HY-13110 HY-13110 H9-13120 H9-13120	SET1300 SET1079		SET1306 SET1091 SET1094 SET1025			
<b>22/24/25/26T [6X2]- UNL SERIES U15</b>							
	V9-75 L V9-75 L HY-13110 HY-13110 H9-13120 H9-13120 HN9-75 HN9-75	SET1300 SET1079		SET1306 SET1091 SET1094 SET1025 SET1300 SET1079			
<b>24T [6X2]-FNL SERIES M09</b>							
	VF-65 L VF-80 L VF-80 L HY-1175 HY-1175 H7-1080 H7-1080 H7-1080 H7-1080 HN7-67 H9-1180 H9-1180	SET1078 SET1300 SET1079		SET1306 SET1091 SET1306 SET1049 SET1306 SET1049 SET1078 SET1306 SET1049			

				 			
<b>MAN</b>							
<b>24T [6X2/4]-FVL SERIES M10</b>							
	V7-80 L V7-80 L H7-1080/ H7-1180 H7-1080/ H7-1180 HY-1175 HY-1175 H7-1080/ H7-1180 H7-1080/ H7-1180 H9-1180 H9-1180	SET1300 SET1079		SET1306 SET1049 SET1306 SET1091 SET1306 SET1049 SET1306 SET1049		   	
<b>26T [4X2]-FNLL SERIES F19</b>							
	V9-75 L V9-75 L HY-13110 HY-13110 H9-13120 H9-13120 HN9-75 HN9-75	SET1300 SET1079		SET1306 SET1091 SET1094 SET1025 SET1300 SET1079			
<b>26/27/28/30/32/33T [6X6]-DFA SERIES F10</b>							
	VA9-0950 VA9-0950 H9-1080/1180 H9-1080/1180 H9-1080/1180 H9-1080/1180 HD9-16120 HD9-1380 HD9-1080/1180 HD9-1080/1180 HD9-1380 HD9-1380 HD9-13120 HD9-13120 HD9-13120	XGA32021X SET1049		SET1306 SET1049 SET1306 SET1049 SET1094 SET1094 SET1306 SET1049 SET1094 SET1025 SET1094 SET1025 SET1094		        	
<b>26/27/28/30/32/33T [6X4]-DF SERIES F 09</b>							
	V9-75 L V9-75 L V9-90 L V9-90 L HD7-1380 HD7-1380 HD9-1080/1180 HD9-1080/1180 HD9-16120 HD9-1380 HD9-1380 HD9-1380 HD9-1380 HD9-1380 HD9-1380 HD9-13120	SET1300 SET1079 XGA32021X SET1049		SET1094 SET1025 SET1306 SET1049 SET1094 SET1094 SET1025 SET1094 SET1025 SET1094 SET1094		      	









# APPLICATION LISTINGS - TRUCK

A

				 			
<b>MAN</b>							
<b>26/27/28/30/32/33T [6X4]-DF SERIES F 09 ...</b>							
	HD9-13120		SET1025			81.35701.0127	
	HD9-13120		SET1094			81.35701.0081	
<b>32/35/41T-VFA SERIES E15 [8X8/4] [8X6/4] [8X4/4]</b>							
	VA9-0950	XGA32021X					
	VA9-0950	SET1049					
	VA9-90 L	XGA32021X					
	VA9-90 L	SET1049					
	HD9-1080/1180		SET1306				
	HD9-1080/1180		SET1049				
	HD9-1380		SET1094				
	HD9-1380		SET1025				
	HD9-1080/1180		SET1306				
	HD9-1080/1180		SET1049				
	HD9-13120		SET1094				
	HD9-13120		SET1025				
	HD9-13120		SET1094				
	HD9-13120		SET1025				
	HD9-1380		SET1094				
<b>38/40T [6X6]-DFA SERIES F12</b>							
	VA9-0950	XGA32021X					
	VA9-0950	SET1049					
	HD9-16120		SET1094				
<b>40T [6X4]-DF SERIES F11</b>							
	V9-90 L	XGA32021X					
	V9-90 L	SET1049					
	HD9-16120		SET1094				
<b>41T-VFA SERIES E15</b>							
	V9-90 L	XGA32021X					
	V9-90 L	SET1049					
	HD9-1380/H9-1380		SET1094				
	HD9-1380/H9-1380		SET1025				
	HD9-1080/H9-1080		SET1306				
	HD9-1080/H9-1080		SET1049				
	HD9-13120/H9-13120		SET1094				
	HD9-13120/H9-13120		SET1025				
<b>ECONIC 2628</b>							
	VL 4/52 DC-7.5	SET1307				9423340701, 9493340501	































































































				 			
<b>MAN</b>							
<b>F/L/M 2000 SERIES</b>							
	V9-32 L	SET1106					-04/94
	V9-32 L	SET1106					05/94 -
	V9-34 L	EK50024					-04/94
	V9-34 L	32207					-04/94
	V9-34 L	EK50024					05/94 -
	V9-34 L	32207					05/94 -
	V9-40 L	EK50024					-04/94
	V9-40 L	32207					-04/94
	V9-40 L	EK50024					05/94 -
	V9-40 L	32207					05/94 -
	V9-42 L	EK50024					05/94 -
	V9-42 L	32207					05/94 -
	V9-50 L/V9-60 L	SET1109					-07/96
	V9-50 L/V9-60 L	SET1109					08/96 -, 19.5"
	V9-50 L/V9-60 L	SET1109					08/96 -, 20/22.5"
	V9-67 L	SET1109					
	V9-75 L/V9-80 L	SET1300					
	V9-75 L/V9-80 L	SET1079					
	VA9-0540	SET1047					
	VA9-0540	SET1045					
	VA9-0950	XGA32021X					
	VA9-0950	SET1049					
	HY-0645/HY-0745		SET408				
	HY-0855		SET1089				
	HY-0955/HY-1175		SET1024				
	HY-0955/HY-1175		SET1101				
	HY-13110		SET1306				
	HY-13110		SET1091				
	HN9-75		SET1300				
	HN9-75		SET1079				
	H9-0670		SET1047				
	H9-0670		SET1045				
	H9-1180		SET1306				
	H9-1180		SET1049				
	H9-1380/13120		SET1094				
	H9-1380/13120		SET1025				
	HD9-1180		SET1306				
	HD9-1180		SET1049				
	HD9-1380/13120		SET1094				
	HD9-1380/13120		SET1025				
	HD9-16120		SET1094				
<b>TGA 18T [4X4] BB D28</b>							
	H9-13120		SET1094				
	H9-13120		SET1025				
	HP-1652		SET1094				
<b>TGA 26T [6X4] BB D28</b>							
	H9-13120		SET1094				
	H9-13120		SET1025				
	H9-16120		SET1094				
	HP-1652		SET1094				



# APPLICATION LISTINGS - TRUCK























































A



























































						
<b>MAN</b>						
<b>TGA 26T [6X6] BB D20</b>						
	HD9-13120 HD9-13120			SET1094 SET1025	I O	
<b>TGA 32T [8X4] BB D28</b>						
	H9-13120 H9-13120			SET1094 SET1025	I O	
<b>TGA 33T [6X2-2] BL D28</b>						
	H9-13120 H9-13120			SET1094 SET1025	I O	
<b>TGA 33T [6X4] BB D28</b>						
	H9-13120 H9-13120 H9-16120 HP-1652			SET1094 SET1025 SET1094 SET1094	I O I I	
<b>TGA 33T [6X6] BB D20</b>						
	HD9-13120 HD9-13120			SET1094 SET1025	I O	
<b>TGA 35T [8X4] BB D28</b>						
	H9-13120 H9-13120			SET1094 SET1025	I O	
<b>TGA 41T [8X6] BB D28</b>						
	H9-13120 H9-13120			SET1094 SET1025	I O	
<b>TGA 41T [8X4] BB-WW D28</b>						
	H9-13120 H9-13120 H9-16120			SET1094 SET1025 SET1094	I O I	
<b>TGA 41T [8X4/4] BB/BL D28</b>						
	H9-13120 H9-13120			SET1094 SET1025	I O	
<b>TGA 50T [8X4] BB-WW D28</b>						
	H9-13120 H9-13120 H9-16120			SET1094 SET1025 SET1094	I O I	
<b>MERCEDES-BENZ</b>						
<b>ACTROS 1800 SERIES</b>						
	VL 4/27 D-7.5 VL 4/27 D-7.5 VL 4/27 D-7.5 VL 4/27 D-7.5 VL 4/50 DC-7.5 VL 4/50 DC-7.5		SET1307 SET1079 SET1307 SET1079 SET1114 SET1079		I O I O I O	 942334001, 9493340501  446053-  

		  		
<b>MERCEDES-BENZ</b>				
<b>ACTROS 1800 SERIES ...</b>				
VL 4/50 DC-7.5	SET1081			 9423340801
VL 4/50 DC-7.5	SET1307			 9423340701
VL 4/50 DC-7.5	SET1081			 9423340701
VL 4/51 DC-7.5	SET1114			
VL 4/51 DC-7.5	SET1079			
VL 4/51 DC-7.5	SET1081			 9423340801
VL 4/51 DC-7.5	SET1307			 9423340701
VL 4/51 DC-7.5	SET1081			 9423340701
VL 4/52 DC-7.5	SET1114			
VL 4/52 DC-7.5	SET1079			
VL 4/52 DC-7.5	SET1081			 9423340801
VL 4/52 DC-7.5	SET1307			 9423340701
VL 4/52 DC-7.5	SET1081			 9423340701
VL 4/53 DC-7.5	SET1114			
VL 4/53 DC-7.5	SET1079			
VL 4/53 DC-7.5	SET1081			 9423340801
VL 4/53 DC-7.5	SET1307			 9423340701
VL 4/53 DC-7.5	SET1081			 9423340701
VL 4/54 DC-8	SET1114			
VL 4/54 DC-8	SET1079			
VL 4/54 DC-8	SET1081			 9423340801
VL 4/54 DC-8	SET1307			 9423340701
VL 4/54 DC-8	SET1081			 9423340701
VL 4/55 D-7.5	SET1114			
VL 4/55 D-7.5	SET1079			
VL 4/55 D-7.5	SET1081			 9423340801
VL 4/55 D-7.5	SET1307			 9423340701
VL 4/55 D-7.5	SET1081			 9423340701
VL 4/55 D-7.5	SET1079			
VL 4/56 D-7.5	SET1114			
VL 4/56 D-7.5	SET1079			
VL 4/56 D-7.5	SET1081			 9423340801
VL 4/56 D-7.5	SET1307			 9423340701
VL 4/56 D-7.5	SET1081			 9423340701
VL 4/57 D-7.1	SET1301			 446052
VL 4/57 D-7.1	SET1307			 446053-
VL 4/57 D-7.1	SET1079			
VL 5/1 D-9	SET115			
VL 5/1 D-9	SET1080			
VL 5/1 D-9	SET1080			
VL 5/1 D-9	SET1080			
VL 5/20 DC-9	SET1080			
VL 5/20 DC-9	SET1080			
VL 5/21 DC-9	SET1080			
VL 5/21 DC-9	SET1080			
HL 7/052 DS-11.5	SET1094	SET1094		 3463563001
HL 7/052 DS-13	SET1093	SET1093		 3553564401
HL 7/052 DS-13	SET1050	SET1050		 3553564401
HL 7/052 DS-13	SET1094	SET1094		3553563001
HL 7/50 DC-11.5	SET1093	SET1093		3553564401
HL 7/50 DC-11.5	SET1050	SET1050		3553564401
HL 7/50 DC-11.5	SET1094	SET1094		3553563001
HL 7/50 DCGS-11.5	SET1093	SET1093		3553564401
HL 7/50 DCGS-11.5	SET1050	SET1050		3553564401
HL 7/50 DCGS-11.5	SET1094	SET1094		3553563001

















































A

									
<b>MERCEDES-BENZ</b>									
<b>ACTROS 1800 SERIES ...</b>									
	HL 7/50 DCS-11.5		SET1093	I		3553564401			
	HL 7/50 DCS-11.5		SET1050	O		3553564401			
	HL 7/50 DCS-11.5		SET1094	I		3553563001			
	HL 7/50 DCS-13		SET1093	I		3553564401			
	HL 7/50 DCS-13		SET1050	O		3553564401			
	HL 7/50 DCS-13		SET1094	I		3553563001			
	HL 7/52 DS-11.5		SET1093	I		3553564401			
	HL 7/52 DS-11.5		SET1050	O		3553564401			
	HL 7/52 DS-11.5		SET1094	I		3553563001			
	HL 7/53 DS-16		SET1093	I		3553564401			
	HL 7/53 DS-16		SET1050	O		3553564401			
	HL 7/53 DS-16		SET1094	I		3553563001			
	NS 4.50 DC-10		SET1092	I					
	NS 4.50 DC-10		SET1102	O					
	NS 4/50 DCL-7.5		SET1307	I					
	NS 4/50 DCL-7.5		SET1081	O					
<b>ACTROS 1900 SERIES</b>									
	VL 4/50 DC-7.5	SET1307		I		942334001, 9493340501			
	VL 4/50 DC-7.5	SET1079		O					
	VL 4/51 DC-7.5	SET1307		I		942334001, 9493340501			
	VL 4/51 DC-7.5	SET1079		O					
	VL 4/52 DC-7.5	SET1307		I		942334001, 9493340501			
	VL 4/52 DC-7.5	SET1079		O					
	VL 4/53 DC-7.5	SET1307		I		942334001, 9493340501			
	VL 4/53 DC-7.5	SET1079		O					
	VL 4/54 DC-8	SET1307		I		942334001, 9493340501			
	VL 4/54 DC-8	SET1079		O					
	VL 4/55 D-7.5	SET1307		I		942334001, 9493340501			
	VL 4/55 D-7.5	SET1079		O					
	VL 4/56 D-7.5	SET1307		I		942334001, 9493340501			
	VL 4/56 D-7.5	SET1079		O					
	VL 5/1 D -9	SET1080		I					
	VL 5/1 D -9	SET1080		O					
	VL 5/1 D -9	SET1080		I					
	VL 5/1 D -9	SET115		O					
	VL 5/20 DC-9	SET1080		I					
	VL 5/20 DC-9	SET1080		O					
	VL 5/21 DC-9	SET1080		I					
	VL 5/21 DC-9	SET1080		O					
	HL 7/052 DS-13		SET1094	I		3463563001			
	HL 7/50 DC-11.5		SET1094	O		3463563001			
	HL 7/50 DCGS-11.5		SET1094	I		3463563001			
	HL 7/50 DCS-11.5		SET1094	O		3463563001			
	HL 7/50 DCS-13		SET1094	I		3463563001			
	HL 7/52 DS-11.5		SET1094	O		3463563001			
	HL 7/53 DS-16		SET1094	I		3463563001			
	NS 4/50 DCL-7.5		SET1307	O					
<b>ACTROS 2000 SERIES</b>									
	AL 7/52 D-7.5	SET1091		I					
	AL 7/52 D-7.5	XGA32021X		O					
	AL 7/52 D-9	SET1091		I					
	AL 7/52 D-9	XGA32021X		O					

					
<b>MERCEDES-BENZ</b>					
<b>ACTROS 2000 SERIES ...</b>					
AL 7/52 DS-7.5	SET1091				
AL 7/52 DS-7.5	XGA32021X				
VL 4/50 DC-7.5	SET1114				
VL 4/50 DC-7.5	SET1079				
VL 4/50 DC-7.5	SET1081				 942 334 0801
VL 4/50 DC-7.5	SET1307				 942 334 0701
VL 4/50 DC-7.5	SET1081				 942 334 0701
VL 4/51 DC-7.5	SET1114				
VL 4/51 DC-7.5	SET1079				
VL 4/51 DC-7.5	SET1081				 942 334 0801
VL 4/51 DC-7.5	SET1307				 942 334 0701
VL 4/51 DC-7.5	SET1081				 942 334 0701
VL 4/52 DC-7.5	SET1114				
VL 4/52 DC-7.5	SET1079				
VL 4/52 DC-7.5	SET1081				 942 334 0801
VL 4/52 DC-7.5	SET1307				 942 334 0701
VL 4/52 DC-7.5	SET1081				 942 334 0701
VL 4/53 DC-7.5	SET1114				
VL 4/53 DC-7.5	SET1079				
VL 4/53 DC-7.5	SET1081				 942 334 0801
VL 4/53 DC-7.5	SET1307				 942 334 0701
VL 4/53 DC-7.5	SET1081				 942 334 0701
VL 4/54 DC-8	SET1114				
VL 4/54 DC-8	SET1079				
VL 4/54 DC-8	SET1081				 942 334 0801
VL 4/54 DC-8	SET1307				 942 334 0701
VL 4/54 DC-8	SET1081				 942 334 0701
VL 4/55 D-7.5	SET1114				
VL 4/55 D-7.5	SET1079				
VL 4/55 D-7.5	SET1081				 942 334 0801
VL 4/55 D-7.5	SET1307				 942 334 0701
VL 4/55 D-7.5	SET1081				 942 334 0701
VL 4/56 D-7.5	SET1114				
VL 4/56 D-7.5	SET1079				
VL 4/56 D-7.5	SET1081				 942 334 0801
VL 4/56 D-7.5	SET1307				 942 334 0701
VL 4/56 D-7.5	SET1081				 942 334 0701
VL 4/57 D-7.1	SET1301				 - 446052
VL 4/57 D-7.1	SET1307				 - 446052
VL 4/57 D-7.1	SET1079				 446053-
VL 5/1 D-9	SET115				
VL 5/1 D-9	SET1080				
VL 5/1 D-9	SET1080				
VL 5/1 D-9	SET1080				
VL 5/20 DC-9	SET1080				
VL 5/20 DC-9	SET1080				
VL 5/21 DC-9	SET1080				
VL 5/21 DC-9	SET1080				
HL 7/052 DS-13		SET1093			 3553564401
HL 7/052 DS-13		SET1050			 3553564401
HL 7/052 DS-13		SET1094			 3553563001
HL 7/052 DS-13		SET1094			 3553563001
HL 7/50 DC-11.5		SET1093			 3553564401
HL 7/50 DC-11.5		SET1050			 3553564401
HL 7/50 DC-11.5		SET1094			 3553563001



A

							
<b>MERCEDES-BENZ</b>							
<b>ACTROS 2000 SERIES ...</b>							
	HL 7/50 DCGS-11.5 HL 7/50 DCGS-11.5 HL 7/50 DCGS-11.5 HL 7/50 DCS-11.5 HL 7/50 DCS-11.5 HL 7/50 DCS-11.5 HL 7/50 DCS-13 HL 7/50 DCS-13 HL 7/50 DCS-13 HL 7/52 DS-11.5 HL 7/52 DS-11.5 HL 7/52 DS-11.5 HL 7/53 DS-16 HL 7/53 DS-16 HL 7/53 DS-16 NS 4.50 DC-10 NS 4.50 DC-10 NS 4/50 DCL-7.5 NS 4/50 DCL-7.5		SET1093 SET1050 SET1094 SET1093 SET1050 SET1094 SET1093 SET1050 SET1094 SET1093 SET1050 SET1094 SET1093 SET1050 SET1094 SET1092 SET1102 SET1307 SET1081		 3553564401  3553564401  3553563001  3553564401  3553564401  3553563001  3553564401  3553563001  3553564401  3553563001  3553564401  3553564401  3463563001		
<b>ACTROS 2500 SERIES</b>							
	VL 4/50 DC-7.5 VL 4/50 DC-7.5 VL 4/50 DC-7.5 VL 4/50 DC-7.5 VL 4/50 DC-7.5 VL 4/51 DC-7.5 VL 4/51 DC-7.5 VL 4/51 DC-7.5 VL 4/51 DC-7.5 VL 4/51 DC-7.5 VL 4/51 DC-7.5 VL 4/52 DC-7.5 VL 4/52 DC-7.5 VL 4/52 DC-7.5 VL 4/52 DC-7.5 VL 4/52 DC-7.5 VL 4/52 DC-7.5 VL 4/53 DC-7.5 VL 4/53 DC-7.5 VL 4/53 DC-7.5 VL 4/53 DC-7.5 VL 4/53 DC-7.5 VL 4/54 DC-8 VL 4/54 DC-8 VL 4/54 DC-8 VL 4/54 DC-8 VL 4/55 D-7.5 VL 4/55 D-7.5 VL 4/55 D-7.5 VL 4/55 D-7.5 VL 4/55 D-7.5 VL 4/56 D-7.5 VL 4/56 D-7.5	SET1114 SET1079 SET1081 SET1307 SET1081 SET1114 SET1079 SET1081 SET1307 SET1081 SET1083 SET1079 SET1081 SET1307 SET1081 SET1114 SET1079 SET1081 SET1307 SET1081 SET1114 SET1079 SET1081 SET1307 SET1081 SET1114 SET1079 SET1081 SET1307 SET1081 SET1114 SET1079 SET1081		 942 334 0801  942 334 0701  942 334 0701  942 334 0801  942 334 0701  942 334 0701  942 334 0801  942 334 0701  942 334 0701  942 334 0701  942 334 0801  942 334 0701  942 334 0701  942 334 0801  942 334 0701  942 334 0701  942 334 0701  942 334 0801  942 334 0701  942 334 0701  942 334 0701  942 334 0801  942 334 0701  942 334 0701  942 334 0701  942 334 0801			

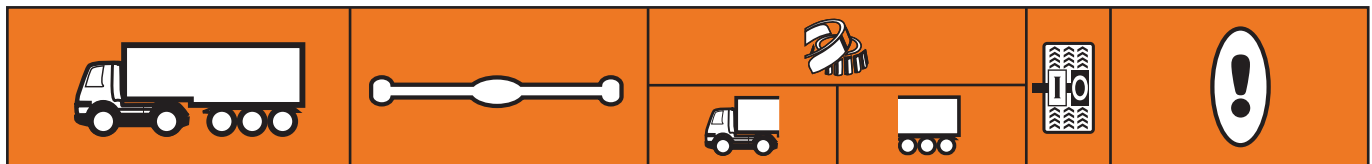

**MERCEDES-BENZ**  
**ACTROS 2500 SERIES ...**







VL 4/56 D-7.5	SET1307		942 334 0701 942 334 0701 - 446052 446053-
VL 4/56 D-7.5	SET1081		
VL 4/57 D-7.1	SET1301		
VL 4/57 D-7.1	SET1307		
VL 4/57 D-7.1	SET1079		
VL 5/1 D-9	SET115		
VL 5/1 D-9	SET1080		
VL 5/1 D-9	SET1080		
VL 5/1 D-9	SET1080		
VL 5/20 DC-9	SET1080		
VL 5/20 DC-9	SET1080		
VL 5/21 DC-9	SET1080		
VL 5/21 DC-9	SET1080		
HL 7/052 DS-13	SET1093		
HL 7/052 DS-13	SET1050		
HL 7/052 DS-13	SET1094		
HL 7/052 DS-13	SET1309		
HL 7/50 DC-11.5	SET1093		
HL 7/50 DC-11.5	SET1050		
HL 7/50 DC-11.5	SET1094		
HL 7/50 DC-11.5	SET1309		
HL 7/50 DCGS-11.5	SET1093		
HL 7/50 DCGS-11.5	SET1050		
HL 7/50 DCGS-11.5	SET1094		
HL 7/50 DCGS-11.5	SET1309		
HL 7/50 DCS-11.5	SET1093		
HL 7/50 DCS-11.5	SET1050		
HL 7/50 DCS-11.5	SET1094		
HL 7/50 DCS-11.5	SET1309		
HL 7/50 DCS-13	SET1093		
HL 7/50 DCS-13	SET1050		
HL 7/50 DCS-13	SET1094		
HL 7/50 DCS-13	SET1309		
HL 7/52 DS-11.5	SET1093		
HL 7/52 DS-11.5	SET1050		
HL 7/52 DS-11.5	SET1094		
HL 7/52 DS-11.5	SET1309		
NS 4.50 DC-10	SET1092		
NS 4.50 DC-10	SET1102		
NS 4/50 DCL-7.5	SET1307		
NS 4/50 DCL-7.5	SET1081		

**ACTROS 2600 SERIES**









































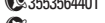
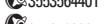
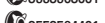

VL 4/50 DC-7.5	SET1114		942 334 0801 942 334 0701 942 334 0701 942 334 0801 942 334 0701 942 334 0701
VL 4/50 DC-7.5	SET1079		
VL 4/50 DC-7.5	SET1081		
VL 4/50 DC-7.5	SET1307		
VL 4/50 DC-7.5	SET1081		
VL 4/51 DC-7.5	SET1114		
VL 4/51 DC-7.5	SET1079		
VL 4/51 DC-7.5	SET1081		
VL 4/51 DC-7.5	SET1307		
VL 4/51 DC-7.5	SET1081		
VL 4/51 DC-7.5	SET1081		
VL 4/52 DC-7.5	SET1114		

# APPLICATION LISTINGS - TRUCK

A





					
<b>MERCEDES-BENZ</b> <b>ACTROS 2600 SERIES ...</b>					
VL 4/52 DC-7.5 VL 4/52 DC-7.5 VL 4/52 DC-7.5 VL 4/52 DC-7.5 VL 4/53 DC-7.5 VL 4/53 DC-7.5 VL 4/53 DC-7.5 VL 4/53 DC-7.5 VL 4/53 DC-7.5 VL 4/53 DC-7.5 VL 4/53 DC-7.5 VL 4/54 DC-8 VL 4/54 DC-8 VL 4/54 DC-8 VL 4/54 DC-8 VL 4/54 DC-8 VL 4/55 D-7.5 VL 4/55 D-7.5 VL 4/55 D-7.5 VL 4/55 D-7.5 VL 4/56 D-7.5 VL 4/56 D-7.5 VL 4/56 D-7.5 VL 4/56 D-7.5 VL 4/56 D-7.5 VL 4/57 D-7.1 VL 4/57 D-7.1 VL 4/57 D-7.1 VL 5/1 D-9 VL 5/1 D-9 VL 5/1 D-9 VL 5/1 D-9 VL 5/20 DC-9 VL 5/20 DC-9 VL 5/21 DC-9 VL 5/21 DC-9 HL 7/052 DS-13 HL 7/052 DS-13 HL 7/052 DS-13 HL 7/052 DS-13 HL 7/50 DC-11.5 HL 7/50 DC-11.5 HL 7/50 DC-11.5 HL 7/50 DCGS-11.5 HL 7/50 DCGS-11.5 HL 7/50 DCGS-11.5 HL 7/50 DCGS-11.5 HL 7/50 DCS-11.5 HL 7/50 DCS-11.5 HL 7/50 DCS-11.5 HL 7/50 DCS-11.5 HL 7/50 DCS-13 HL 7/50 DCS-13 HL 7/50 DCS-13	SET1079 SET1081 SET1307 SET1081 SET1114 SET1079 SET1081 SET1307 SET1081 SET1114 SET1079 SET1081 SET1307 SET1081 SET1114 SET1079 SET1081 SET1307 SET1081 SET1114 SET1079 SET1081 SET1307 SET1081 SET1301 SET1307 SET1079 SET115 SET1080 SET1080 SET1080 SET1080 SET1080 SET1080 SET1093 SET1050 SET1094 SET1309 SET1093 SET1050 SET1094 SET1309 SET1093 SET1050 SET1094 SET1309 SET1093 SET1050 SET1094		SET1093 SET1050 SET1094 SET1309 SET1093 SET1050 SET1094 SET1309 SET1093 SET1050 SET1094 SET1309 SET1093 SET1050 SET1094 SET1309 SET1093 SET1050 SET1094 SET1309 SET1093 SET1050 SET1094		942 334 0801 942 334 0701 942 334 0701 942 334 0801 942 334 0701 942 334 0701 942 334 0801 942 334 0701 942 334 0701 942 334 0801 942 334 0701 942 334 0701 446052 446053- 3553564401 3553564401 3553563001 3553563001 3553564401 3553564401 3553563001 3553563001 3553564401 3553564401 3553563001 3553563001 3553564401 3553563001 3553563001 3553564401 3553564401 3553563001 3553563001 3553564401 3553564401



				 			
<b>MERCEDES-BENZ</b>							
<b>ACTROS 2600 SERIES ...</b>							
	HL 7/50 DCS-13 HL 7/52 DS-11.5 HL 7/52 DS-11.5 HL 7/52 DS-11.5 HL 7/52 DS-11.5 NS 4.50 DC-10 NS 4.50 DC-10 NS 4/50 DCL-7.5 NS 4/50 DCL-7.5		SET1309 SET1093 SET1050 SET1094 SET1309 SET1092 SET1102 SET1307 SET1081				 3553563001  3553564401  3553564401  3553563001  3553563001
<b>ACTROS 3200 SERIES</b>							
	VL 4/53 DC-7.5 VL 4/53 DC-7.5 VL 4/53 DC-7.5 VL 4/53 DC-7.5 VL 4/53 DC-7.5 VL 4/55 D-7.5 VL 4/55 D-7.5 VL 4/55 D-7.5 VL 4/55 D-7.5 VL 4/55 D-7.5 VL 4/57 D-7.1 VL 4/57 D-7.1 VL 4/57 D-7.1 HL 7/052 DS-13 HL 7/052 DS-13 HL 7/052 DS-13 HL 7/50 DC-11.5 HL 7/50 DC-11.5 HL 7/50 DC-11.5 HL 7/50 DCGS-11.5 HL 7/50 DCGS-11.5 HL 7/50 DCGS-11.5 HL 7/50 DCS-11.5 HL 7/50 DCS-11.5 HL 7/50 DCS-11.5 HL 7/52 DS-11.5 HL 7/52 DS-11.5 HL 7/52 DS-11.5 NS 4.50 DC-10 NS 4.50 DC-10 NS 4/50 DCL-7.5 NS 4/50 DCL-7.5	SET1114 SET1079 SET1081 SET1307 SET1081 SET1114 SET1079 SET1081 SET1307 SET1081 SET1301 SET1307 SET1079				 9423340801  942 334 0701  942 334 0701  9423340801  942 334 0701  942 334 0701  9423340801  942 334 0701  942 334 0701  - 446052  446053-  3553564401  3553564401  3553563001  3553564401  3553564401  3553563001  3553564401  3553564401  3553563001  3553564401  3553563001  3553564401  3553564401  3553563001	
<b>ACTROS 3300 SERIES</b>							
	VL 4/50 DC-7.5 VL 4/50 DC-7.5 VL 4/50 DC-7.5 VL 4/50 DC-7.5 VL 4/50 DC-7.5 VL 4/54 DC-8 VL 4/54 DC-8 VL 4/54 DC-8 VL 4/54 DC-8	SET1114 SET1079 SET1081 SET1307 SET1081 SET1114 SET1079 SET1081 SET1307				 942 334 0801  942 334 0701  942 334 0701  942 334 0801  942 334 0801	





























































A

									
<b>MERCEDES-BENZ</b>									
<b>ACTROS 3300 SERIES ...</b>									
VL 4/54 DC-8		SET1081							942 334 0701
VL 4/55 D-7.5		SET1114							
VL 4/55 D-7.5		SET1079							
VL 4/55 D-7.5		SET1081							942 334 0801
VL 4/55 D-7.5		SET1307							942 334 0701
VL 4/55 D-7.5		SET1081							942 334 0701
VL 4/56 D-7.5		SET1114							
VL 4/56 D-7.5		SET1079							
VL 4/56 D-7.5		SET1081							942 334 0801
VL 4/56 D-7.5		SET1307							942 334 0701
VL 4/56 D-7.5		SET1081							942 334 0701
VL 5/1 D-9		SET115							
VL 5/1 D-9		SET1080							
VL 5/1 D-9		SET1080							
VL 5/1 D-9		SET1080							
VL 5/20 DC-9		SET1080							
VL 5/20 DC-9		SET1080							
VL 5/21 DC-9		SET1080							
VL 5/21 DC-9		SET1080							
HL 7/050 DCS-13			SET1093						3553564401
HL 7/050 DCS-13			SET1050						3553564401
HL 7/050 DCS-13			SET1094						3553563001
HL 7/052 DS-13			SET1093						3553564401
HL 7/052 DS-13			SET1050						3553564401
HL 7/052 DS-13			SET1094						3553563001
HL 7/50 DCS-16			SET1093						3553564401
HL 7/50 DCS-16			SET1050						3553564401
HL 7/50 DCS-16			SET1094						3553563001
HL 7/52 DS-11.5			SET1093						3553564401
HL 7/52 DS-11.5			SET1050						3553564401
HL 7/52 DS-11.5			SET1094						3553563001
HL 7/53 DS-16			SET1093						3553564401
HL 7/53 DS-16			SET1050						3553564401
HL 7/53 DS-16			SET1094						3553563001
NS 4.50 DC-10			SET1092						
NS 4.50 DC-10			SET1102						
NS 4/50 DCL-7.5			SET1307						
NS 4/50 DCL-7.5			SET1081						







































































































## ACTROS 4100 SERIES

VL 4/27 D-7.5		SET1114							
VL 4/27 D-7.5		SET1079							
VL 4/27 D-7.5		SET1081							942 334 0801
VL 4/27 D-7.5		SET1307							942 334 0701
VL 4/27 D-7.5		SET1081							942 334 0701
VL 4/53 DC-7.5		SET1114							
VL 4/53 DC-7.5		SET1079							
VL 4/53 DC-7.5		SET1081							942 334 0801
VL 4/53 DC-7.5		SET1307							942 334 0701
VL 4/53 DC-7.5		SET1081							942 334 0701
VL 4/55 D-7.5		SET1114							
VL 4/55 D-7.5		SET1079							
VL 4/55 D-7.5		SET1081							942 334 0801
VL 4/55 D-7.5		SET1307							942 334 0701

				 			
<b>MERCEDES-BENZ</b>							
<b>ACTROS 4100 SERIES ...</b>							
	VL 4/55 D-7.5 VL 4/57 D-7.1 VL 4/57 D-7.1 VL 4/57 D-7.1 VL 5/1 D-9 VL 5/1 D-9 VL 5/1 D-9 VL 5/1 D-9 HL 7/050 DCS-13 HL 7/050 DCS-13 HL 7/050 DCS-13 HL 7/052 DS-13 HL 7/052 DS-13 HL 7/052 DS-13 HL 7/53 DS-16 HL 7/53 DS-16 HL 7/53 DS-16 NS 4.50 DC-10 NS 4.50 DC-10 NS 4/50 DCL-7.5 NS 4/50 DCL-7.5	SET1081 SET1301 SET1307 SET1079 SET115 SET1080 SET1080 SET1080		SET1093 SET1050 SET1094 SET1093 SET1050 SET1094 SET1093 SET1050 SET1094 SET1092 SET1102 SET1307 SET1081		 942 334 0701  - 446052  446053-               	 942 334 0701  - 446052  446053-  3553564401  3553564401  3553563001  3553564401  3553564401  3553564401  3553564401  3553564401  3553564401  3553564401  3553564401  3553564401  3553564401  3553563001
<b>ATEGO 700 SERIES</b>							
	VL 2/21 DC-3.5 VL 2/21 DC-3.5 VL 2/21 DC-3.5 VL 2/21 DC-3.5 HL 2/43 DC-6.2	SET1098 SET1074 SET1098 SET1074	SET1086		 6683560101/0201		
<b>ATEGO 800 SERIES</b>							
	VL 2/21 DC-3.5 VL 2/21 DC-3.5 VL 2/22 DC-4.1 VL 2/22 DC-4.1 HL 2/43 DC-6.2 HL 4/40 DC-7 HL 4/40 DC-7 HL 4/40 DC-7 HL 4/40 DC-7 HL 4/40 DC-7 HL 4/40 DC-7 HL 4/40 DC-7 HL 4/40 DC-7 HL 4/40 DC-7 HL 4/40 DC-7	SET1098 SET1074 SET1098 SET1074	SET1086 33017 SET1088 SET1092 SET1102 SET1091 SET1048 SET401 39586/39528		 668 356 0101/0201  9723560101  9723560101  9763561101  6783560401  6783560401  6753560101  6753560101		
<b>ATEGO 900 SERIES</b>							
	AL 3/40 D-4.7 VL 2/22 DC-4.1 VL 2/22 DC-4.1 VL 3/21 DC-5.3 VL 3/21 DC-5.3 HL 2/43 DC-6.2 HL 4/40 D-7 HL 4/40 D-7 HL 4/40 D-7	33017 SET1098 SET1074 SET1113 SET1108	SET1086 33017 SET1088 SET1092		 6683560101/0201  972 3560101  972 3560101  9763561101		









































































































A

				 			
<b>MERCEDES-BENZ</b>							
<b>ATEGO 900 SERIES ...</b>							
HL 4/40 D-7			SET1102			9763561101	
HL 4/40 D-7			SET1091			6783560401	
HL 4/40 D-7			SET1048			6783560401	
HL 4/40 D-7			SET401			6753560101	
HL 4/40 D-7			39586/39528			6753560101	
HL 4/40 DC-7			33017			9723560101	
HL 4/40 DC-7			SET1088			9723560101	
HL 4/40 DC-7			SET1092			9763561101	
HL 4/40 DC-7			SET1102			9763561101	
HL 4/40 DC-7			SET1091			6783560401	
HL 4/40 DC-7			SET1048			6783560401	
HL 4/40 DC-7			SET401			6753560101	
HL 4/40 DC-7			39586/39528			6753560101	
HL 4/40 DS-7.7			33017			972 3560101	
HL 4/40 DS-7.7			SET1088			972 3560101	
HL 4/40 DS-7.7			SET1092			9763561101	
HL 4/40 DS-7.7			SET1102			9763561101	
HL 4/40 DS-7.7			SET1091			6783560401	
HL 4/40 DS-7.7			SET1048			6783560401	
HL 4/40 DS-7.7			SET401			6753560101	
HL 4/40 DS-7.7			39586/39528			6753560101	
<b>ATEGO 1000 SERIES</b>							
AL 3/40 D-4.7		33017					
VL 2/22 DC-4.1		SET1098					
VL 2/22 DC-4.1		SET1074					
VL 3/21 DC-5.3		SET1113					
VL 3/21 DC-5.3		SET1108					
HL 2/43 DC-6.2			SET1086			668 356 0101/0201	
HL 4/40 D-7			33017			9723560101	
HL 4/40 D-7			SET1088			9723560101	
HL 4/40 D-7			SET1092			9763561101	
HL 4/40 D-7			SET1102			9763561101	
HL 4/40 D-7			SET1091			6783560401	
HL 4/40 D-7			SET1048			6783560401	
HL 4/40 D-7			SET401			6753560101	
HL 4/40 D-7			39586/39528			6753560101	
HL 4/40 DC-7			33017			9723560101	
HL 4/40 DC-7			SET1088			9723560101	
HL 4/40 DC-7			SET1092			9763561101	
HL 4/40 DC-7			SET1102			9763561101	
HL 4/40 DC-7			SET1091			6783560401	
HL 4/40 DC-7			SET1048			6783560401	
HL 4/40 DC-7			SET401			6753560101	
HL 4/40 DC-7			39586/39528			6753560101	
HL 4/40 DS-7.7			33017			9723560101	
HL 4/40 DS-7.7			SET1088			9723560101	
HL 4/40 DS-7.7			SET1092			9763561101	
HL 4/40 DS-7.7			SET1102			9763561101	
HL 4/40 DS-7.7			SET1091			6783560401	
HL 4/40 DS-7.7			SET1048			6783560401	
HL 4/40 DS-7.7			SET401			6753560101	
HL 4/40 DS-7.7			39586/39528			6753560101	



A



























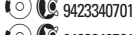



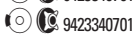













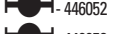



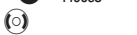





				 			
<b>MERCEDES-BENZ</b>							
<b>ATEGO 1800 SERIES ...</b>							
	VL 5/21 DC-9 HL 7/50 DCS-11.5 HL 7/50 DCS-11.5 HL 7/50 DCS-11.5 HL 7/50 DCS-13 HL 7/50 DCS-13 HL 7/50 DCS-13 HL 7/52 DS-13 HL 7/52 DS-13 HL 7/52 DS-13 HL 8/1 DCS-13 HL 8/1 DCS-13 NS 4.50 DC-10 NS 4.50 DC-10 NS 4/50 DCL-7.5 NS 4/50 DCL-7.5	<b>SET1080</b>	<b>SET1093</b> <b>SET1050</b> <b>SET1094</b> <b>SET1093</b> <b>SET1050</b> <b>SET1094</b> <b>SET1093</b> <b>SET1050</b> <b>SET1094</b> <b>SET1094</b> <b>SET317</b> <b>SET1092</b> <b>SET1102</b> <b>SET1307</b> <b>SET1081</b>		            	 3553564401  3553564401  3553563001  3553564401  3553564401  3553563001  3553564401  3553564401  3553563001  3553564401  3553563001	
<b>ATEGO 2500 SERIES</b>							
	VL 4/51 DC-7.5 VL 4/51 DC-7.5 VL 4/51 DC-7.5 VL 4/51 DC-7.5 VL 4/51 DC-7.5 VL 4/52 DC-7.5 VL 4/52 DC-7.5 VL 4/52 DC-7.5 VL 4/52 DC-7.5 VL 4/52 DC-7.5 VL 4/52 DC-7.5 VL 4/53 DC-7.5 VL 4/53 DC-7.5 VL 4/53 DC-7.5 VL 4/53 DC-7.5 VL 4/53 DC-7.5 VL 4/53 DC-7.5 VL 4/53 DC-7.5 VL 4/54 DC-8 VL 4/54 DC-8 VL 4/54 DC-8 VL 4/54 DC-8 VL 4/54 DC-8 VL 4/57 D-7.1 VL 4/57 D-7.1 VL 4/57 D-7.1 VL 5/21 DC-9 VL 5/21 DC-9 HL 7/052 DS-13 HL 7/052 DS-13 HL 7/052 DS-13 HL 7/50 DCS-11.5 HL 7/50 DCS-11.5 HL 7/50 DCS-11.5 HL 8/1 DCS-13 HL 8/1 DCS-13 NS 4.50 DC-10 NS 4.50 DC-10 NS 4/50 DCL-7.5 NS 4/50 DCL-7.5	<b>SET1114</b> <b>SET1079</b> <b>SET1081</b> <b>SET1307</b> <b>SET1081</b> <b>SET1114</b> <b>SET1079</b> <b>SET1081</b> <b>SET1307</b> <b>SET1081</b> <b>SET1114</b> <b>SET1079</b> <b>SET1081</b> <b>SET1307</b> <b>SET1081</b> <b>SET1114</b> <b>SET1079</b> <b>SET1081</b> <b>SET1307</b> <b>SET1081</b> <b>SET1114</b> <b>SET1079</b> <b>SET1081</b> <b>SET1307</b> <b>SET1081</b> <b>SET1307</b> <b>SET1081</b> <b>SET1301</b> <b>SET1307</b> <b>SET1079</b> <b>SET1080</b> <b>SET1080</b>	<b>SET1093</b> <b>SET1050</b> <b>SET1094</b> <b>SET1093</b> <b>SET1050</b> <b>SET1094</b> <b>SET1094</b> <b>SET317</b> <b>SET1092</b> <b>SET1102</b> <b>SET1307</b> <b>SET1081</b>		                              	                              	

					
<p><b>MERCEDES-BENZ</b> <b>ATEGO 2600 SERIES</b></p>					
	<ul style="list-style-type: none"> <li>VL 4/50 DC-7.5</li> <li>VL 4/50 DC-7.5</li> <li>VL 4/50 DC-7.5</li> <li>VL 4/50 DC-7.5</li> <li>VL 4/50 DC-7.5</li> <li>VL 4/51 DC-7.5</li> <li>VL 4/51 DC-7.5</li> <li>VL 4/51 DC-7.5</li> <li>VL 4/51 DC-7.5</li> <li>VL 4/51 DC-7.5</li> <li>VL 4/51 DC-7.5</li> <li>VL 4/51 DC-7.5</li> <li>VL 4/54 DC-8</li> <li>VL 4/54 DC-8</li> <li>VL 4/54 DC-8</li> <li>VL 4/54 DC-8</li> <li>VL 4/54 DC-8</li> <li>VL 4/55 D-7.5</li> <li>VL 4/55 D-7.5</li> <li>VL 4/55 D-7.5</li> <li>VL 4/56 D-7.5</li> <li>VL 4/56 D-7.5</li> <li>VL 4/56 D-7.5</li> <li>VL 4/56 D-7.5</li> <li>VL 4/56 D-7.5</li> <li>HL 7/50 DC-11.5</li> <li>HL 7/50 DC-11.5</li> <li>HL 7/50 DC-11.5</li> <li>HL 7/50 DCGS-11.5</li> <li>HL 7/50 DCGS-11.5</li> <li>HL 7/50 DCGS-11.5</li> <li>HL 7/52 DS-11.5</li> <li>HL 7/52 DS-11.5</li> <li>HL 7/52 DS-11.5</li> <li>NS 4.50 DC-10</li> <li>NS 4.50 DC-10</li> <li>NS 4/50 DCL-7.5</li> <li>NS 4/50 DCL-7.5</li> </ul>	<ul style="list-style-type: none"> <li>SET1114</li> <li>SET1079</li> <li>SET1081</li> <li>SET1307</li> <li>SET1081</li> <li>SET1114</li> <li>SET1079</li> <li>SET1081</li> <li>SET1307</li> <li>SET1081</li> <li>SET1114</li> <li>SET1079</li> <li>SET1081</li> <li>SET1307</li> <li>SET1081</li> <li>SET1081</li> <li>SET1081</li> <li>SET1307</li> <li>SET1081</li> <li>SET1114</li> <li>SET1079</li> <li>SET1081</li> <li>SET1307</li> <li>SET1081</li> <li>SET1093</li> <li>SET1050</li> <li>SET1094</li> <li>SET1093</li> <li>SET1050</li> <li>SET1094</li> <li>SET1094</li> <li>SET1093</li> <li>SET1050</li> <li>SET1092</li> <li>SET1102</li> <li>SET1307</li> <li>SET1081</li> </ul>	<ul style="list-style-type: none"> <li>SET1093</li> <li>SET1050</li> <li>SET1094</li> <li>SET1093</li> <li>SET1050</li> <li>SET1094</li> <li>SET1094</li> <li>SET1093</li> <li>SET1050</li> <li>SET1092</li> <li>SET1102</li> <li>SET1307</li> <li>SET1081</li> </ul>		<ul style="list-style-type: none"> <li>9423340801</li> <li>9423340701</li> <li>9423340701</li> <li>9423340801</li> <li>9423340701</li> <li>9423340701</li> <li>9423340801</li> <li>9423340701</li> <li>9423340701</li> <li>9423340801</li> <li>9423340701</li> <li>9423340701</li> <li>3553564401</li> <li>3553564401</li> <li>3553563001</li> <li>3553564401</li> <li>3553563001</li> <li>3553563001</li> <li>3553564401</li> <li>3553564401</li> </ul>
<p><b>AXOR 1800 SERIES</b></p>					
	<ul style="list-style-type: none"> <li>AL 7/52 D-7.5</li> <li>AL 7/52 D-7.5</li> <li>AL 7/52 D-9</li> <li>AL 7/52 D-9</li> <li>AL 7/52 DS-7.5</li> <li>AL 7/52 DS-7.5</li> <li>VL 4/27 D-7.5</li> <li>VL 4/27 D-7.5</li> <li>VL 4/27 D-7.5</li> <li>VL 4/50 DC-7.5</li> <li>VL 4/50 DC-7.5</li> <li>VL 4/50 DC-7.5</li> <li>VL 4/50 DC-7.5</li> <li>VL 4/50 DC-7.5</li> <li>VL 4/51 DC-7.5</li> </ul>	<ul style="list-style-type: none"> <li>SET1091</li> <li>XGA32021X</li> <li>SET1091</li> <li>XGA32021X</li> <li>SET1091</li> <li>XGA32021X</li> <li>SET1307</li> <li>SET1079</li> <li>SET1079</li> <li>SET1114</li> <li>SET1079</li> <li>SET1081</li> <li>SET1307</li> <li>SET1081</li> <li>SET1307</li> <li>SET1114</li> </ul>			<ul style="list-style-type: none"> <li>446053-</li> <li>446053-</li> <li>446052</li> <li>9423340801</li> <li>9423340701</li> <li>9423340701</li> </ul>













A







					
<b>MERCEDES-BENZ</b>					
<b>AXOR 1800 SERIES ...</b>					
VL 4/51 DC-7.5	SET1079				
VL 4/51 DC-7.5	SET1081				
VL 4/51 DC-7.5	SET1307				
VL 4/51 DC-7.5	SET1081				
VL 4/51 DC-7.5	SET1307				
VL 4/52 DC-7.5	SET1114				
VL 4/52 DC-7.5	SET1079				
VL 4/52 DC-7.5	SET1081				
VL 4/52 DC-7.5	SET1307				
VL 4/52 DC-7.5	SET1081				
VL 4/53 DC-7.5	SET1114				
VL 4/53 DC-7.5	SET1079				
VL 4/53 DC-7.5	SET1081				
VL 4/53 DC-7.5	SET1307				
VL 4/53 DC-7.5	SET1081				
VL 4/54 DC-8	SET1114				
VL 4/54 DC-8	SET1079				
VL 4/54 DC-8	SET1081				
VL 4/54 DC-8	SET1307				
VL 4/54 DC-8	SET1081				
VL 4/54 DC-8	SET1307				
VL 4/55 D-7.5	SET1114				
VL 4/55 D-7.5	SET1079				
VL 4/55 D-7.5	SET1081				
VL 4/55 D-7.5	SET1307				
VL 4/55 D-7.5	SET1081				
VL 4/56 D-7.5	SET1114				
VL 4/56 D-7.5	SET1079				
VL 4/56 D-7.5	SET1081				
VL 4/56 D-7.5	SET1307				
VL 4/56 D-7.5	SET1081				
VL 4/56 D-7.5	SET1307				
VL 4/56 D-7.5	SET1079				
VL 4/56 D-7.5	SET1079				
VL 4/57 D-7.1	SET1301				
VL 4/57 D-7.1	SET1079				
VL 4/57 D-7.1	SET1307				
VL 4/57 D-7.1	SET1079				
VL 5/1 D-9	SET115				
VL 5/1 D-9	SET1080				
VL 5/1 D-9	SET1080				
VL 5/1 D-9	SET1117				
VL 5/1 D-9	SET1080				
VL 5/20 DC-9	SET1080				
VL 5/21 DC-9	SET1080				
VL 5/21 DC-9	SET1080				
VL 5/21 DC-9	SET1117				
VL 5/21 DC-9	SET1080				
HL 6/1 DC-13		SET1094			
HL 6/3 DC-13		SET1094			
HL 7/052 DS-11.5		SET1094			
HL 7/052 DS-13		SET1093			











A









					
<p><b>MERCEDES-BENZ</b></p>					
<p><b>AXOR 2500 SERIES ...</b></p>					
	<p>VL 5/1 D-9 VL 5/1 D-9 VL 5/21 DC-9 VL 5/21 DC-9 HL 6/1 DC-13 HL 6/1 DC-13 HL 6/3 DC-13 HL 6/3 DC-13 HL 7/056 DS-13 HL 7/056 DS-13 HL 7/52 DS-13 HL 7/52 DS-13 HL 7/56 DS-13 HL 7/56 DS-13 HL 8/1 DCS-13 HL 8/1 DCS-13 NS 4/50 DCL-7.5</p>	<p>SET1117 SET1080 SET1117 SET1080</p>	<p>SET1094 SET317 SET1094 SET317 SET1094 SET317 SET1094 SET317 SET1094 SET317 SET1094 SET317</p>		
<p><b>AXOR 2600 SERIES</b></p>					
	<p>AL 7/52 D-7.5 AL 7/52 D-7.5 AL 7/52 D-9 AL 7/52 D-9 AL 7/52 DS-7.5 AL 7/52 DS-7.5 VL 4/27 D-7.5 VL 4/27 D-7.5 VL 4/27 D-7.5 VL 4/50 DC-7.5 VL 4/51 DC-7.5 VL 4/54 DC-8 VL 4/55 D-7.5 VL 4/56 D-7.5 VL 4/56 D-7.5 VL 4/56 D-7.5 VL 4/57 D-7.1 VL 4/57 D-7.1 VL 4/57 D-7.1 VL 4/57 D-7.1 VL 5/1 D-9 VL 5/1 D-9 VL 5/21 DC-9 VL 5/21 DC-9 HL 6/1 DC-13 HL 6/1 DC-13 HL 6/3 DC-13 HL 6/3 DC-13 HL 7/056 DS-13 HL 7/056 DS-13 HL 7/52 DS-13 HL 7/52 DS-13 HL 7/56 DS-13 HL 7/56 DS-13 HL 8/1 DCS-13</p>	<p>SET1091 XGA32021X SET1091 XGA32021X SET1091 XGA32021X SET1307 SET1079 SET1079 SET1307 SET1307 SET1307 SET1079 SET1079 SET1307 SET1079 SET1301 SET1079 SET1307 SET1079 SET1117 SET1080 SET1117 SET1080</p>	<p>SET1094 SET317 SET1094 SET317 SET1094 SET317 SET1094 SET317 SET1094 SET317 SET1094 SET317</p>		<p>446053- 446053- 446052 9423340701, 9493340501 9423340701, 9493340501 446053- 446052 446053- 446053- 446052 446052 446053- 446053-</p>

				 			
<b>MERCEDES-BENZ</b>							
<b>AXOR 2600 SERIES ...</b>							
	HL 8/1 DCS-13 NS 4/50 DCL-7.5		SET317 SET1307				
<b>AXOR 3200 SERIES</b>							
	AL 7/52 D-7.5 AL 7/52 D-7.5 AL 7/52 D-9 AL 7/52 D-9 AL 7/52 DS-7.5 AL 7/52 DS-7.5 VL 4/27 D-7.5 VL 4/27 D-7.5 VL 4/27 D-7.5 VL 4/50 DC-7.5 VL 4/51 DC-7.5 VL 4/54 DC-8 VL 4/55 D-7.5 VL 4/56 D-7.5 VL 4/56 D-7.5 VL 4/56 D-7.5 VL 4/57 D-7.1 VL 4/57 D-7.1 VL 4/57 D-7.1 VL 4/57 D-7.1 VL 4/57 D-7.1 VL 5/1 D-9 VL 5/1 D-9 VL 5/21 DC-9 VL 5/21 DC-9 HL 6/1 DC-13 HL 6/1 DC-13 HL 6/3 DC-13 HL 6/3 DC-13 HL 7/056 DS-13 HL 7/056 DS-13 HL 7/52 DS-13 HL 7/52 DS-13 HL 7/56 DS-13 HL 7/56 DS-13 HL 8/1 DCS-13 HL 8/1 DCS-13 NS 4/50 DCL-7.5	SET1091 XGA32021X SET1091 XGA32021X SET1091 XGA32021X SET1307 SET1079 SET1079 SET1307 SET1307 SET1307 SET1079 SET1307 SET1079 SET1307 SET1079 SET1079 SET1301 SET1079 SET1307 SET1079 SET1117 SET1080 SET1117 SET1080	SET1094 SET317 SET1094 SET317 SET1094 SET317 SET1094 SET317 SET1094 SET317 SET1094 SET317 SET1094 SET317 SET1094				446053- 446053- - 446052 9423340701, 9493340501 9423340701, 9493340501 446053- 446053- 446053- - 446052 - 446052 - 446052 446053- 446053-
<b>LK 700 SERIES</b>							
	VL 1/10 C-2.5 VL 1/10 C-2.5 VL 1/8 D-2.5 VL 1/8 D-2.5 VL 1/9 C-2.3 VL 1/9 C-2.3 VL 2/5-2.2 VL 2/5-2.2 HL 1/8-4.7 HL 1/8-4.7 HL 1/9-5.6	SET1097 33205 SET1097 33205 SET1097 33205 SET1041 32206	SET1044 SET1041 SET1086				











A

									
									
<b>MERCEDES-BENZ</b>									
<b>LK 700 SERIES ...</b>									
	HL 2/12 D-4.5				SET1044				
	HL 2/12 D-4.5				SET1041				
	HL 2/13 D-6.4				SET325				
	HL 2/15-5.8				SET1086				
	HL 2/2 L-4.8				SET98				
	HL 2/2 L-4.8				SET272				
	HL 2/2-4.8				SET98				
	HL 2/2-4.8				SET272				
<b>LK 800 SERIES</b>									
	VL 1/10 C-2.5			SET1097					
	VL 1/10 C-2.5			33205					
	VL 2/10 D-3.5			SET1111					
	VL 2/10 D-3.5			SET1074					
	VL 2/12 D-3.8			SET1111					
	VL 2/12 D-3.8			EK50029					
	VL 2/4-3.4			SET1098					
	VL 2/4-3.4			SET1074					
	VL 2/6-3.1			SET1098					
	VL 2/6-3.1			SET1074					
	VL 2/8-3.2			SET1111					
	VL 2/8-3.2			SET1074					
	VL 2/9 D-3.1			SET1098					
	VL 2/9 D-3.1			SET1074					
	VL 3/11 D-4.4			SET1113					
	VL 3/11 D-4.4			SET1108					
	HL 1/9-5.6				SET1086				
	HL 2/11 D-5.8				SET1086				
	HL 2/12 D-4.5				SET1044				
	HL 2/12 D-4.5				SET1041				
	HL 2/13 D-6.4				SET325				
	HL 2/15 S-5.8				SET1086				
	HL 2/15-5.8				SET1086				
	HL 2/3-5.7				SET928				
	HL 2/3-5.7				SET1098				
	HL 2/4 L-6.4				SET325				
	HL 2/4-6.4				SET325				
	HL 4/1-7.6				SET1065				
	HL 4/1-7.6				39586/39528				
	HL 4/23-7.7				SET401				
	HL 4/23-7.7				39586/39528				
	HL 4/28 D-7.8				SET401				
	HL 4/28 D-7.8				39586/39528				
	HL 4/29 D-9.2				SET1103				
	HL 4/30 D-6.4				SET1046				
	HL 4/30 DS-6.4				SET1046				
	HL 4/35 D-6.4				SET1046				
	HL 4/4-8.8				SET1066				
<b>LK 900 SERIES</b>									
	VL 2/10 D-3.5			SET1111					
	VL 2/10 D-3.5			SET1074					
	VL 2/10 D-3.5			SET1111					
	VL 2/10 D-3.5			SET1074					

					
<b>MERCEDES-BENZ</b>					
<b>LK 900 SERIES ...</b>					
	VL 2/11 D-3.8 VL 2/11 D-3.8 VL 2/12 D-3.8 VL 2/12 D-3.8 VL 2/4-3.4 VL 2/4-3.4 VL 2/6-3.1 VL 2/6-3.1 VL 3/11 D-4.4 VL 3/11 D-4.4 VL 3/1-8.8 VL 3/1-8.8 HL 2/13 D-6.4 HL 2/4 L-6.4 HL 2/4-6.4 HL 4/1-7.6 HL 4/1-7.6 HL 4/23 L-7.7 HL 4/23 L-7.7 HL 4/28 D-7.8 HL 4/28 D-7.8 HL 4/29 D-9.2 HL 4/30 D-6.4 HL 4/30 DS-6.4 HL 4/31 DS-7.0 HL 4/35 D-6.4 HL 4/4-8.8	SET1111 EK50029 SET1111 EK50029 SET1098 SET1074 SET1098 SET1074 SET1113 SET1108 EK50036 EK50029	SET325 SET325 SET325 SET1065 39586/39528 SET401 39586/39528 SET401 39586/39528 SET1103 SET1046 SET1046 SET1103 SET1046 SET1066		
<b>LK 1000 SERIES</b>					
	VL 2/6-3.1 VL 2/6-3.1 VL 2/7-3.6 VL 2/7-3.6 VL 3/1-3.8 VL 3/1-3.8 VL 3/4 -5 VL 3/4 -5 VL 3/6-4.1 VL 3/6-4.1 VL 3/7 -5 VL 3/7 -5 HL 2/4 L-6.4 HL 2/7-7.7 HL 2/7-7.7 HL 4/01 L-10 HL 4/01 L-10 HL 4/01-10 HL 4/01-10 HL 4/16 L-7.7 HL 4/16 L-7.7 HL 4/16-7.7 HL 4/16-7.7 HL 4/17 L-9.2 HL 4/17 S-9.2	SET1098 SET1074 SET1111 SET1074 EK50036 EK50029 EK50036 EK50029 SET1113 SET1108 SET1113 SET1108	JM714249/10 SET401 39586/39528 SET1092 SET1103 SET1092 SET1103 SET401 39586/39528 SET401 39586/39528 SET1066 SET1066		



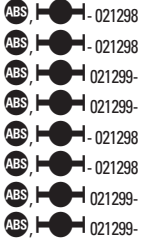

					
<b>MERCEDES-BENZ</b>					
<b>LK 1000 SERIES ...</b>					
	HL 4/1-7.6 HL 4/1-7.6 HL 4/17-9.2 HL 4/23 L-7.7 HL 4/23 L-7.7 HL 4/23-7.7 HL 4/23-7.7 HL 4/23-7.7 HL 4/4-8.8 HL 4/8 L-10 HL 4/8 L-10 HL 4/8-6.3 HL 4/8-6.3 HL 7/1 S -10 HL 7/1 S -10 HL 7/1 S-10 HL 7/1 S-10 HL 7/1-10 HL 7/1-10 HL 7/1-10 HL 7/1-10		SET1065 39586/39528 SET1066 SET401 39586/39528 SET401 39586/39528 SET1066 SET1091 SET1115 SET1091 SET1115 SET1093 SET1049 SET1306 SET1049 SET1093 SET1049 SET1306 SET1049		
<b>LK 1100 SERIES</b>					
	VL 2/11 D-3.8 VL 2/11 D-3.8 VL 2/8-3.2 VL 2/8-3.2 VL 3/11 D-4.4 VL 3/11 D-4.4 VL 3/13 D-5.3 VL 3/13 D-5.3 HL 4/05 D-9.2 HL 4/05 D-9.2 HL 4/09 D-9.2 HL 4/09 D-9.2 HL 4/1-7.6 HL 4/1-7.6 HL 4/23 L-7.7 HL 4/23 L-7.7 HL 4/23-7.7 HL 4/23-7.7 HL 4/28 D-7.8 HL 4/28 D-7.8 HL 4/29 D-9.2 HL 4/31 DS-7.0 HL 4/4-8.8 HL 5/2 S-6.5 HL 5/2 S-6.5	SET1111 EK50029 SET1111 SET1074 SET1113 SET1108 SET1114 SET1109	SET1091 SET1115 SET1091 SET1115 SET1065 39586/39528 SET401 39586/39528 SET401 39586/39528 SET401 39586/39528 SET1103 SET1103 SET1066 SET1091 SET1115		
<b>LK 1200 SERIES</b>					
	VL 3/6 D-4.1 VL 3/6 D-4.1 VL 3/6-4.1 VL 3/6-4.1 VL 3/7 D-5	SET1113 SET1108 SET1113 SET1108 SET1113			

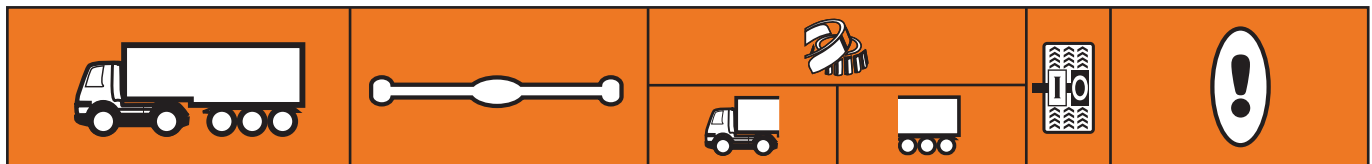







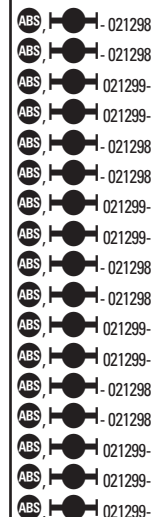
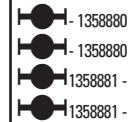









**MERCEDES-BENZ**

**LK 1200 SERIES ...**

















VL 3/7 D-5	SET1108				
VL 3/7-5	SET1113				
VL 3/7-5	SET1108				
VL 3/8-6	SET1114				
VL 3/8-6	SET1109				
VL 3/8-6	SET1114				
VL 3/8-6	SET1110				
VL 4/3-6	SET1114				
VL 4/3-6	SET1109				
HL 4/01 L-10			SET1092		
HL 4/01 L-10			SET1103		
HL 4/01-10			SET1092		
HL 4/01-10			SET1103		
HL 4/038 D-10			SET1092		
HL 4/038 D-10			SET1103		
HL 4/038 D-9.4			SET1092		
HL 4/038 D-9.4			SET1103		
HL 4/039 D-10			SET1092		
HL 4/039 D-10			SET1103		
HL 4/07 D-9.4			SET1092		
HL 4/07 D-9.4			SET1103		
HL 4/16 L-7.7			SET401		
HL 4/16 L-7.7			39586/39528		
HL 4/16-7.7			SET401		
HL 4/16-7.7			39586/39528		
HL 4/17 D-9.2			SET1066		
HL 4/17 L-9.2			SET1066		
HL 4/17-9.2			SET1066		
HL 4/29 D-9.2			SET1103		
HL 4/4-8.8			SET1066		
HL 4/8 L-10			SET1091		
HL 4/8 L-10			SET1115		
HL 4/8-10			SET1091		
HL 4/8-10			SET1115		
HL 5/1 Z-10			598/592A		
HL 5/1 Z-10			SET1064		
HL 7/024 D-12.3			SET1093		
HL 7/024 D-12.3			SET1091		
HL 7/1 D-10			SET1093		
HL 7/1 D-10			SET1049		
HL 7/1 D-10			SET1306		
HL 7/1 D-10			SET1049		
HL 7/1 L-10			SET1093		
HL 7/1 L-10			SET1049		
HL 7/1 L-10			SET1306		
HL 7/1 L-10			SET1049		
HL 7/1 S-10			SET1093		
HL 7/1 S-10			SET1049		
HL 7/1 S-10			SET1306		
HL 7/1 S-10			SET1049		
HL 7/1-10			SET1093		
HL 7/1-10			SET1049		
HL 7/1-10			SET1306		
HL 7/1-10			SET1049		
HL 7/18 D-13			SET1094		



A





















				 			
<b>MERCEDES-BENZ</b>							
<b>LK 1200 SERIES ...</b>							
	HL 7/18 D-13 HL 7/18 D-13 HL 7/18 D-13 HL 7/26 DL-12.3 HL 7/26 DL-12.3		SET1025 SET1094 SET1025 SET1093 SET1091		 - 021299-  - 021298  - 021298		
<b>LK 1300 SERIES</b>							
	AL 7/1 D-7 AL 7/1 D-7 VL 2/10 D-3.5 VL 2/10 D-3.5 VL 2/12 D-3.8 VL 2/12 D-3.8 VL 3/11 D-4.4 VL 3/11 D-4.4 VL 3/12 D-5.3 VL 3/12 D-5.3 VL 3/13 D-5.3 VL 3/13 D-5.3 VL 4/23 D-6.7 VL 4/23 D-6.7 VL 4/3-6 VL 4/3-6 HL 1/8-4.7 HL 1/8-4.7 HL 4/05 D-9.2 HL 4/05 D-9.2 HL 4/29 D-9.2 HL 4/32 D-10.6 HL 4/32 D-10.6 HL 4/4-8.8 HL 4/8-10 HL 4/8-10 HL 5/1 Z-10 HL 5/1 Z-10	XGA32021X SET1049 SET1111 SET1074 SET1111 EK50029 SET1113 SET1108 SET1113 SET1108 SET1114 SET1109 SET1301 SET1079 SET1114 SET1109	SET1044 SET1041 SET1091 SET1115 SET1103 SET1091 SET1115 SET1066 SET1091 SET1115 598/592A SET1064				
<b>LK 1400 SERIES</b>							
	VL 3/15 D-6.5 VL 3/15 D-6.5 VL 3/7 D-5 VL 3/7 D-5 VL 3/7-5 VL 3/7-5 VL 3/8 D-6.5 VL 3/8 D-6.5 VL 3/8-6 VL 3/8-6 VL 3/8-6 VL 3/8-6 VL 4/10 D-7 VL 4/10 D-7 VL 4/10 DL-7 VL 4/10 DL-7 VL 4/24 D-6.7	SET1114 SET1110 SET1113 SET1108 SET1113 SET1108 SET1114 SET1110 SET1114 SET1109 SET1114 SET1110 SET1110 SET1301 SET1110 SET1301 SET1110 SET1301			 - 1358880  - 1358880  1358881 -  1358881 -		









							
<b>MERCEDES-BENZ</b>							
<b>LK 1400 SERIES ...</b>							
VL 4/24 D-6.7	SET1110						
VL 4/25 DL-6.7	SET1301						
VL 4/25 DL-6.7	SET1110						
VL 4/25 DL-7.1	SET1301						
VL 4/25 DL-7.1	SET1110						
VL 4/29 D-7.5	SET1114						
VL 4/29 D-7.5	SET1079						
VL 4/30 DL-7.5	SET1114						
VL 4/30 DL-7.5	SET1079						
VL 4/3-6	SET1114						
VL 4/3-6	SET1109						
VL 4/36 D-6.7	SET1301						
VL 4/36 D-6.7	SET1079						
VL 4/36 D-7.1	SET1301						
VL 4/36 D-7.1	SET1079						
HH 4/19 D-10			SET1091				
HH 4/19 D-10			SET1115				
HL 4/01 D-10			SET1092				
HL 4/01 D-10			SET1103				
HL 4/01 DL-10			SET1092				
HL 4/01 DL-10			SET1103				
HL 4/01 L-10			SET1092				
HL 4/01 L-10			SET1103				
HL 4/01-10			SET1092				
HL 4/01-10			SET1103				
HL 4/038 D-10			SET1092				
HL 4/038 D-10			SET1103				
HL 4/039 D-10			SET1092				
HL 4/039 D-10			SET1103				
HL 4/17 D-9.2			SET1066				
HL 4/17-9.2			SET1066				
HL 4/8 D-10			SET1091				
HL 4/8 D-10			SET1115				
HL 4/8-10			SET1091				
HL 4/8-10			SET1115				
HL 5/2 Z-10			SET1091				
HL 5/2 Z-10			SET1115				
HL 5/2-10			SET1091				
HL 5/2-10			SET1115				
HL 7/021 D-10			SET1093			 - 021298	
HL 7/021 D-10			SET1049			 - 021298	
HL 7/021 D-10			SET1306			 021299-	
HL 7/021 D-10			SET1049			 021299-	
HL 7/021 DL-10			SET1093			 - 021298	
HL 7/021 DL-10			SET1049			 - 021298	
HL 7/021 DL-10			SET1306			 021299-	
HL 7/021 DL-10			SET1049			 - 021299-	
HL 7/024 D-12.3			SET1093				
HL 7/024 D-12.3			SET1049				
HL 7/024 DL-12.3			SET1093				
HL 7/024 DL-12.3			SET1049				
HL 7/1 L-10			SET1093			 - 021298	
HL 7/1 L-10			SET1049			 - 021298	
HL 7/1 D-10			SET1093			 - 021298	
HL 7/1 D-10			SET1049			 - 021298	



A

				 			
<b>MERCEDES-BENZ</b>							
<b>LK 1400 SERIES ...</b>							
	HL 7/1 D-10 HL 7/1 D-10 HL 7/1 DL-10 HL 7/1 DL-10 HL 7/1 DL-10 HL 7/1 DL-10 HL 7/1-10 HL 7/1-10 NS 4/10 D-6.7 NS 4/10 D-6.7		SET1306 SET1049 SET1093 SET1049 SET1306 SET1049 SET1093 SET1049 SET1301 SET1110		 021299-  021299-  - 021298  - 021298  021299-  021299-  - 021298  - 021298		
<b>LK 1500 SERIES</b>							
	VL 3/13 D-5.3 VL 3/13 D-5.3 VL 4/3-6 VL 4/3-6 VL 3/15 D-6.5 VL 3/15 D-6.5 HL 4/035 D-10.6 HL 4/035 D-10.6 HL 4/06 D-12 HL 4/06 D-12 HL 4/32 D-10.6 HL 4/32 D-10.6 HL 4/8-10 HL 4/8-10 HL 5/2 S-10 HL 5/2 S-10 HL 5/2 ZS-10 HL 5/2 ZS-10 HL 5/2-10 HL 5/2-10	SET1114 SET1109 SET1114 SET1109 SET1114 SET1110	SET1092 SET1103 SET1092 SET1103 SET1091 SET1115 SET1091 SET1115 SET1091 SET1115 SET1091 SET1115				
<b>SK 1600 SERIES</b>							
	AL 7/1 D-7 AL 7/1 D-7 VD 4/14 DL-7 VD 4/14 DL-7 VD 4/20 DL-7.5 VD 4/20 DL-7.5 VD 4/20 DL-7.5 VD 4/20 DL-7.5 VL 3/8 D-6.5 VL 3/8 D-6.5 VL 3/8-6 VL 3/8-6 VL 3/8-6 VL 3/8-6 VL 4/10 D-7 VL 4/10 D-7 VL 4/10 D-7 VL 4/10 D-7 VL 4/10 DL-7 VL 4/10 DL-7	XGA32021X SET1049 SET1301 SET1079 SET1301 SET1110 SET1114 SET1079 SET1114 SET1110 SET1114 SET1109 SET1114 SET1110 SET1301 SET1110 SET1301 SET1079 SET1301 SET1110			 - 1358880  - 1358880  1358881 -  1358881 -		

					
<b>MERCEDES-BENZ</b> <b>SK 1600 SERIES ...</b>					
VL 4/15 D-7.5 VL 4/15 D-7.5 VL 4/16 D-7.5 VL 4/16 D-7.5 VL 4/18 D L-7 VL 4/18 D L-7 VL 4/19 D-7.5 VL 4/19 D-7.5 VL 4/2 D-7 VL 4/2 D-7 VL 4/30 DL-7.5 VL 4/30 DL-7.5 VL 4/7 D-7 VL 4/7 D-7 VL 4/7 D-7 VL 4/7 D-7 VL 4/7 D-7 VL 4/7 D-7 VL 4/7 D-7 VL 4/7 D-7 VL 4/7 D-7 VL 4/8 D-7 VL 4/8 D-7 VL 4/9 D-7 VL 4/9 D-7 VL 4/9 D-7 VL 4/9 D-7 HD 7/2 DLG-10 HH 4/04 D-12 HH 4/04 D-12 HL 4/01 D L-10 HL 4/01 D L-10 HL 4/01 D-10 HL 4/01 D-10 HL 4/01 L-10 HL 4/01 L-10 HL 4/01-10 HL 4/01-10 HL 4/06 D L-12 HL 4/06 D L-12 HL 4/06 D-12 HL 4/06 D-12 HL 4/8 D-10 HL 4/8 D-10 HL 4/8 L-10 HL 4/8 L-10 HL 4/8-10 HL 4/8-10 HL 5/2 Z-10 HL 5/2 Z-10 HL 5/2 ZL-10 HL 5/2 ZL-10 HL 5/2-10 HL 5/2-10 HL 7/013 D-16 HL 7/015 D-13	SET1114 SET1079 SET1114 SET1079 SET1301 SET1079 SET1114 SET1079 SET1034 SET1079 SET1114 SET1079 SET1301 SET1110 SET1301 SET1079 SET1301 SET1079 SET1301 SET1110 SET1301 SET1110 SET1301 SET1110 SET1301 SET1110 SET1301 SET1079 SET1306 SET1092 SET1103 SET1092 SET1103 SET1092 SET1103 SET1092 SET1103 SET1092 SET1103 SET1092 SET1103 SET1092 SET1103 SET1092 SET1103 SET1092 SET1103 SET1092 SET1103 SET1092 SET1103 SET1092 SET1103 SET1092 SET1103 SET1092 SET1103 SET1094 SET1094				- 1278813 - 1278813 - 1278814 - - 1278814 - - 724723 - 724723 - 724724 - - 724724 - - 1278813 - 1278813 - 1278814 - - 1278814 - ABS - 021299- ABS - 021298

A







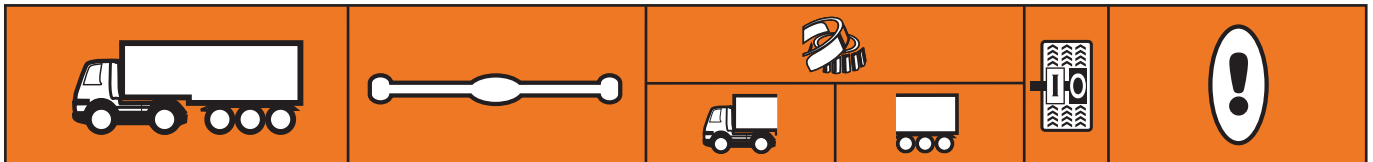





A



**MERCEDES-BENZ**



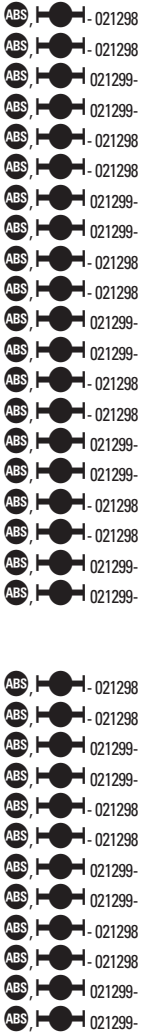























**SK 1600 SERIES ...**









HL 7/015 D-13	SET1025	O	ABS	021298
HL 7/015 D-13	SET1094	O	ABS	021299
HL 7/015 D-13	SET1025	O	ABS	021299
HL 7/015 DL-13	SET1094	O	ABS	021298
HL 7/015 DL-13	SET1025	O	ABS	021298
HL 7/015 DL-13	SET1094	O	ABS	021299
HL 7/015 DL-13	SET1025	O	ABS	021299
HL 7/015 DS-13	SET1094	O	ABS	021298
HL 7/015 DS-13	SET1025	O	ABS	021299
HL 7/015 DS-13	SET1094	O	ABS	021298
HL 7/015 DS-13	SET1025	O	ABS	021299
HL 7/02 DL-10	SET1093	O	ABS	021298
HL 7/02 DL-10	SET1049	O	ABS	021298
HL 7/02 DL-10	SET1306	O	ABS	021299
HL 7/02 DL-10	SET1049	O	ABS	021299
HL 7/021 D-10	SET1093	O	ABS	021298
HL 7/021 D-10	SET1049	O	ABS	021298
HL 7/021 D-10	SET1306	O	ABS	021299
HL 7/021 D-10	SET1049	O	ABS	021299
HL 7/021 DL-10	SET1093	O	ABS	021298
HL 7/021 DL-10	SET1049	O	ABS	021298
HL 7/021 DL-10	SET1306	O	ABS	021299
HL 7/021 DL-10	SET1049	O	ABS	021299
HL 7/024 DL-12.3	SET1093	O	ABS	021298
HL 7/024 DL-12.3	SET1049	O	ABS	021298
HL 7/024 DL-12.3	SET1306	O	ABS	021299
HL 7/024 DL-12.3	SET1049	O	ABS	021299
HL 7/07 D-10	SET1093	O	ABS	021298
HL 7/07 D-10	SET1049	O	ABS	021298
HL 7/07 D-10	SET1306	O	ABS	021299
HL 7/07 D-10	SET1049	O	ABS	021299
HL 7/07 D-11.5	SET1093	O	ABS	021298
HL 7/07 D-11.5	SET1049	O	ABS	021298
HL 7/07 D-11.5	SET1306	O	ABS	021299
HL 7/07 D-11.5	SET1049	O	ABS	021299
HL 7/07 DL-10	SET1093	O	ABS	021298
HL 7/07 DL-10	SET1049	O	ABS	021298
HL 7/07 DL-10	SET1306	O	ABS	021299
HL 7/07 DL-10	SET1049	O	ABS	021299
HL 7/07 DL-11.5	SET1093	O	ABS	021298
HL 7/07 DL-11.5	SET1049	O	ABS	021298
HL 7/07 DL-11.5	SET1306	O	ABS	021299
HL 7/07 DL-11.5	SET1049	O	ABS	021299
HL 7/07 DS-10	SET1093	O	ABS	021298
HL 7/07 DS-10	SET1049	O	ABS	021298
HL 7/07 DS-10	SET1306	O	ABS	021299
HL 7/07 DS-10	SET1049	O	ABS	021299
HL 7/1 D -10	SET1093	O	ABS	021298
HL 7/1 D -10	SET1049	O	ABS	021298
HL 7/1 D -10	SET1306	O	ABS	021299
HL 7/1 D -10	SET1049	O	ABS	021299
HL 7/1 DL-10	SET1093	O	ABS	021298
HL 7/1 DL-10	SET1049	O	ABS	021298
HL 7/1 DL-10	SET1306	O	ABS	021299
HL 7/1 DL-10	SET1049	O	ABS	021299

				 			
<b>MERCEDES-BENZ</b>							
<b>SK 1600 SERIES ...</b>							
	HL 7/1 L-10 HL 7/1 L-10 HL 7/1 L-10 HL 7/1 L-10 HL 7/1 S-10 HL 7/1 S-10 HL 7/1 S-10 HL 7/1 S-10 HL 7/1 S-10 HL 7/1-10 HL 7/1-10 HL 7/1-10 HL 7/1-10 HL 7/15 D-13 HL 7/15 D-13 HL 7/15 D-13 HL 7/15 D-13 HL 7/18 D-13 HL 7/18 D-13 HL 7/18 D-13 HL 7/18 D-13 HL 7/18 D-13 HL 7/18 D-13 HL 7/2 DLG-10 HL 7/2 DLG-10 HL 7/21 D-10 HL 7/21 D-10 HL 7/21 D-10 HL 7/21 D-10 HL 7/3 D-10 HL 7/3 D-10 HL 7/3 D-10 HL 7/3 D-10 HL 7/3 DL-10 HL 7/3 DL-10 HL 7/3 DL-10 HL 7/3 DL-10		SET1093 SET1049 SET1306 SET1049 SET1093 SET1049 SET1306 SET1049 SET1093 SET1049 SET1306 SET1049 SET1093 SET1049 SET1306 SET1049 SET1306 SET1049 SET1093 SET1049 SET1306 SET1049 SET1092 SET1103 SET1093 SET1049 SET1306 SET1049 SET1093 SET1049 SET1306 SET1049 SET1093 SET1049 SET1306 SET1049			- 021298 - 021298 021299- 021299- - 021298 - 021298 021299- 021299- - 021298 - 021298 021299- 021299- - 021298 - 021298 021299- 021299- - 021298 - 021298 021299- 021299- - 021298 - 021298 021299- 021299- - 021298 - 021298 021299- 021299-	
<b>SK 1700 SERIES</b>							
	AL 7/1 D-7 AL 7/1 D-7 VD 4/20 DL-7.5 VD 4/20 DL-7.5 VD 4/26 DL-7.5 VD 4/26 DL-7.5 VL 3/15 D-6.5 VL 3/15 D-6.5 VL 4/10 D-7 VL 4/10 D-7 VL 4/10 D-7 VL 4/10 D-7 VL 4/10 DL-7 VL 4/10 DL-7 VL 4/16 D-7.5 VL 4/16 D-7.5 VL 4/23 D-6.7 VL 4/23 D-6.7		XGA32021X SET1049 SET1114 SET1079 SET1114 SET1079 SET1114 SET1110 SET1301 SET1110 SET1301 SET1079 SET1301 SET1110 SET1114 SET1079 SET1301 SET1079				

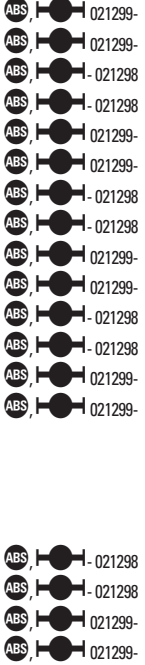

A

					
<b>MERCEDES-BENZ</b>					
<b>SK 1700 SERIES ...</b>					
VL 4/24 D-6.7 VL 4/24 D-6.7 VL 4/24 D-7.1 VL 4/24 D-7.1 VL 4/25 DL-6.7 VL 4/25 DL-6.7 VL 4/27 D-7.5 VL 4/27 D-7.5 VL 4/28 D-7.5 VL 4/28 D-7.5 VL 4/29 D-7.5 VL 4/29 D-7.5 VL 4/30 DL-7.5 VL 4/30 DL-7.5 VL 4/31 DL-7.5 VL 4/31 DL-7.5 VL 4/31 DL-7.5 VL 4/31 DL-7.5 VL 4/8 D-7 VL 4/8 D-7 VL 5/2 D-9 VL 5/2 D-9 HD 7/016 DG-13 HD 7/016 DG-13 HD 7/016 DG-13 HD 7/016 DG-13 HL 4/038 D-12 HL 4/038 D-12 HL 4/039 D-12 HL 4/039 D-12 HL 4/06 D-12 HL 4/06 D-12 HL 4/06 DL-12 HL 4/06 DL-12 HL 7/013 D-16 HL 7/015 D-13 HL 7/015 D-13 HL 7/015 D-13 HL 7/015 D-13 HL 7/015 DL-13 HL 7/015 DL-13 HL 7/015 DL-13 HL 7/015 DL-13 HL 7/024 D-12.3 HL 7/024 D-12.3 HL 7/024 DL-12.3 HL 7/024 DL-12.3 HL 7/025 D-12.3 HL 7/025 D-12.3 HL 7/07 D-10 HL 7/07 D-10 HL 7/07 D-10 HL 7/07 D-10 HL 7/07 D-11.5 HL 7/07 D-11.5	SET1301 SET1079 SET1301 SET1079 SET1301 SET1079 SET1114 SET1079 SET1114 SET1079 SET1114 SET1079 SET1114 SET1079 SET1301 SET1079 SET1114 SET1079 SET1301 SET1110 SET115 SET1080	SET1094 SET1025 SET1094 SET1025 SET1092 SET1103 SET1092 SET1103 SET1092 SET1103 SET1092 SET1103 SET1092 SET1103 SET1094 SET1094 SET1025 SET1094 SET1025 SET1094 SET1025 SET1094 SET1025 SET1093 SET1091 SET1093 SET1091 SET1093 SET1049 SET1306 SET1049 SET1093 SET1049			ABS  - 021298 ABS  - 021298 ABS  021299- ABS  021299-  ABS  - 021298 ABS  - 021298 ABS  021299- ABS  021299- ABS  - 021298 ABS  - 021298 ABS  021299- ABS  021299-  ABS  - 021298 ABS  - 021298 ABS  021299- ABS  021299- ABS  - 021298 ABS  - 021298

					
<b>MERCEDES-BENZ</b>					
<b>SK 1700 SERIES ...</b>					
	HL 7/07 D-11.5 HL 7/07 D-11.5 HL 7/07 DL-10 HL 7/07 DL-10 HL 7/07 DL-10 HL 7/07 DL-10 HL 7/07 DL-10 HL 7/07 DL-11.5 HL 7/07 DL-11.5 HL 7/07 DL-11.5 HL 7/07 DL-11.5 HL 7/18 D-13 HL 7/18 D-13 HL 7/18 D-13 HL 7/18 D-13 HL 7/26 D-12.3 HL 7/26 D-12.3 HL 7/26 DL-12.3 HL 7/26 DL-12.3 HL 7/3 D-10 HL 7/3 D-10 HL 7/3 D-10 HL 7/3 D-10		SET1306 SET1049 SET1093 SET1049 SET1306 SET1049 SET1093 SET1049 SET1306 SET1049 SET1094 SET1025 SET1094 SET1025 SET1093 SET1091 SET1093 SET1091 SET1093 SET1049 SET1306 SET1049		
<b>SK 1800 SERIES</b>					
	AL 7/1 D-7 AL 7/1 D-7 AL 7/1 D-7.637 AL 7/1 D-7.637 AL 7/1 D-7/5.217 AL 7/1 D-7/5.217 VL 3/15 D-6.5 VL 3/15 D-6.5 VL 4/10 D-7 VL 4/10 D-7 VL 4/16 D-7.5 VL 4/16 D-7.5 VL 4/23 D-6.7 VL 4/23 D-6.7 VL 4/24 D-6.7 VL 4/24 D-6.7 VL 4/24 D-7.1 VL 4/24 D-7.1 VL 4/25 DL-6.7 VL 4/25 DL-6.7 VL 4/25 DL-7.1 VL 4/25 DL-7.1 VL 4/26 DL-7.5 VL 4/26 DL-7.5 VL 4/27 D-7.5 VL 4/27 D-7.5 VL 4/27 D-7.5 VL 4/27 D-7.5 VL 4/28 D-7.5 VL 4/28 D-7.5	XGA32021X SET1049 XGA32021X SET1049 XGA32021X SET1049 SET1114 SET1110 SET1301 SET1079 SET1114 SET1079 SET1301 SET1079 SET1301 SET1079 SET1301 SET1079 SET1301 SET1079 SET1301 SET1079 SET1114 SET1079 SET1114 SET1079 SET1114 SET1079 SET1114 SET1079 SET1114 SET1079			



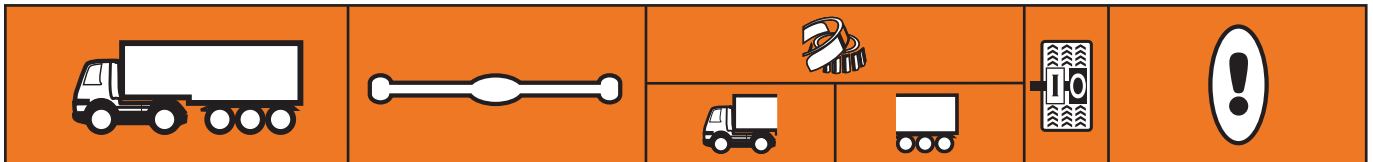







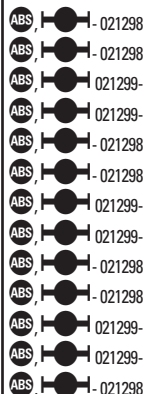
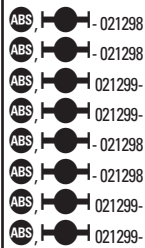

























**MERCEDES-BENZ**

**SK 1800 SERIES ...**

VL 4/29 D-7.5	SET1114		
VL 4/29 D-7.5	SET1079		
VL 4/30 DL-7.5	SET1114		
VL 4/30 DL-7.5	SET1079		
VL 4/31 DL-7.5	SET1114		
VL 4/31 DL-7.5	SET1079		
VL 4/31 DL-7.5	SET1301		
VL 4/31 DL-7.5	SET1079		
VL 4/36 D-6.7	SET1301		
VL 4/36 D-6.7	SET1079		
VL 4/38 D-7.1	SET1301		
VL 4/38 D-7.1	SET1079		
VL 5/1 D-9	SET1080		
VL 5/2 D-9	SET115		
VL 5/2 D-9	SET1080		
VL 5/20 DC-9	SET1080		
VL 5/20 DC-9	SET1080		
VL 5/21 DC-9	SET1080		
VL 5/21 DC-9	SET1080		
HL 4/038 D-12		SET1092	
HL 4/038 D-12		SET1103	
HL 4/039 D-12		SET1092	
HL 4/039 D-12		SET1103	
HL 4/06 D-12		SET1092	
HL 4/06 D-12		SET1103	
HL 4/06 DL-12		SET1092	
HL 4/06 DL-12		SET1103	
HL 7/013 D-16		SET1094	
HL 7/015 D-13		SET1094	
HL 7/015 D-13		SET1025	
HL 7/015 D-13		SET1094	
HL 7/015 D-13		SET1025	
HL 7/015 DL-13		SET1094	
HL 7/015 DL-13		SET1025	
HL 7/015 DL-13		SET1094	
HL 7/015 DL-13		SET1025	
HL 7/024 D-12.3		SET1093	
HL 7/024 D-12.3		SET1091	
HL 7/024 DL-12.3		SET1093	
HL 7/024 DL-12.3		SET1091	
HL 7/025 D-12.3		SET1093	
HL 7/025 D-12.3		SET1091	
HL 7/07 D-10		SET1093	
HL 7/07 D-10		SET1049	
HL 7/07 D-10		SET1306	
HL 7/07 D-10		SET1049	
HL 7/07 D-11.5		SET1093	
HL 7/07 D-11.5		SET1049	
HL 7/07 D-11.5		SET1306	
HL 7/07 D-11.5		SET1049	
HL 7/07 D-11.5/4.572		SET1093	
HL 7/07 D-11.5/4.572		SET1049	
HL 7/07 D-11.5/4.572		SET1306	
HL 7/07 D-11.5/4.572		SET1049	
HL 7/07 DL-10		SET1093	





















					
<b>MERCEDES-BENZ</b>					
<b>SK 1800 SERIES ...</b>					
	HL 7/07 DL-10 HL 7/07 DL-10 HL 7/07 DL-10 HL 7/07 DL-11.5 HL 7/07 DL-11.5 HL 7/07 DL-11.5 HL 7/07 DL-11.5 HL 7/07 DL-11.5 HL 7/26 D-12.3 HL 7/26 D-12.3 HL 7/26 DL-12.3 HL 7/26 DL-12.3 HL 7/50 DCS-11.5 HL 7/50 DCS-11.5 HL 7/50 DCS-11.5 HL 7/56 DS-16 HL 7/56 DS-16 HL 7/56 DS-16 NR 4/11 DL-7.5 NR 4/11 DL-7.5 NR 4/22-8 NR 4/22-8 NS 4/11 D-10 NS 4/11 D-10		SET1049 SET1306 SET1049 SET1093 SET1049 SET1306 SET1049 SET1093 SET1091 SET1093 SET1091 SET1093 SET1050 SET1094 SET1093 SET1050 SET1094 SET1301 SET1079 SET1091 SET1115 SET1091 SET1115		 - 021298  - 021299-  - 021299-  - 021298  - 021298  - 021299-  - 021299-  3553564401  3553564401  3553563001  3553564401  3553564401  3553563001
<b>SK 1900 SERIES</b>					
	AL 7/1 D-7 AL 7/1 D-7 VD 4/14 DL-7 VD 4/14 DL-7 VD 4/20 DL-7.5 VD 4/20 DL-7.5 VD 4/20 DL-7.5 VD 4/20 DL-7.5 VL 3/8 D-6.5 VL 3/8 D-6.5 VL 3/8-6 VL 3/8-6 VL 3/8-6 VL 3/8-6 VL 4/10 D-7 VL 4/10 D-7 VL 4/10 D-7 VL 4/10 D-7 VL 4/15 D-7.5 VL 4/15 D-7.5 VL 4/16 D-7.5 VL 4/16 D-7.5 VL 4/19 D-7.5 VL 4/19 D-7.5 VL 4/23 D-6.7 VL 4/23 D-6.7 VL 4/24 D-6.7 VL 4/24 D-6.7 VL 4/25 DL-6.7 VL 4/25 DL-6.7	XGA32021X SET1049 SET1301 SET1079 SET1114 SET1079 SET1301 SET1114 SET1110 SET1114 SET1109 SET1114 SET1110 SET1301 SET1079 SET1301 SET1110 SET1114 SET1079 SET1114 SET1079 SET1114 SET1079 SET1114 SET1079 SET1114 SET1079 SET1301 SET1079 SET1301 SET1079 SET1301 SET1079 SET1301 SET1079			 1358881 -  1358881 -  - 1358880  - 1358880  1358881 -  1358881 -  1278814 -  1278814 -  - 1278813  - 1278813





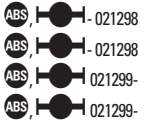

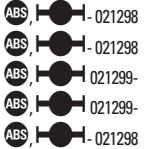

A

									
									
<b>MERCEDES-BENZ</b>									
<b>SK 1900 SERIES ...</b>									
VL 4/27 D-7.5		SET1114							
VL 4/27 D-7.5		SET1079							
VL 4/28 D-7.5		SET1114							
VL 4/28 D-7.5		SET1079							
VL 4/29 D-7.5		SET1114							
VL 4/29 D-7.5		SET1079							
VL 4/2-D7		SET1034							
VL 4/2-D7		SET1079							
VL 4/31 D-7.5		SET1114							
VL 4/31 D-7.5		SET1079							
VL 4/7 D-7		SET1301							
VL 4/7 D-7		SET1079							
VL 4/7 D-7		SET1301							
VL 4/7 D-7		SET1110							
VL 4/9 D-7		SET1301							
VL 4/9 D-7		SET1079							
VL 4/9 D-7		SET1301							
VL 4/9 D-7		SET1110							
VL 5/1 D-9		SET115							
VL 5/1 D-9		SET1080							
VL 5/2 D-9		SET115							
VL 5/2 D-9		SET1080							
HD 7/016 DG-13				SET1094					
HD 7/016 DG-13				SET1025					
HD 7/016 DG-13				SET1094					
HD 7/016 DG-13				SET1025					
HL 7/013 D-16				SET1094					
HL 7/015 D-13				SET1094					
HL 7/015 D-13				SET1025					
HL 7/015 D-13				SET1094					
HL 7/015 D-13				SET1025					
HL 7/015 DL-13				SET1094					
HL 7/015 DL-13				SET1025					
HL 7/015 DL-13				SET1094					
HL 7/015 DL-13				SET1025					
HL 7/015 DS-13				SET1094					
HL 7/015 DS-13				SET1025					
HL 7/015 DS-13				SET1094					
HL 7/015 DS-13				SET1025					
HL 7/07 D-10				SET1093					
HL 7/07 D-10				SET1049					
HL 7/07 D-10				SET1306					
HL 7/07 D-10				SET1049					
HL 7/07 DL-10				SET1093					
HL 7/07 DL-10				SET1049					
HL 7/07 DL-10				SET1306					
HL 7/07 DL-10				SET1049					
HL 7/1-10				SET1093					
HL 7/1-10				SET1049					
HL 7/1-10				SET1306					
HL 7/1-10				SET1049					
HL 7/15 D-13				SET1094					
HL 7/15 D-13				SET1025					
HL 7/15 D-13				SET1094					
HL 7/15 D-13				SET1025					

					
<b>MERCEDES-BENZ</b>					
<b>SK 1900 SERIES ...</b>					
	HL 7/18 D-13 HL 7/18 D-13 HL 7/18 D-13 HL 7/18 D-13 NS 4/11 D-10 NS 4/11 D-10		SET1094 SET1025 SET1094 SET1025 SET1091 SET1115		
<b>SK 2000 SERIES</b>					
	AL 7/1 D-7 AL 7/1 D-7 AL 7/1 D-7.637 AL 7/1 D-7.637 AL 7/1 D-7/5.217 AL 7/1 D-7/5.217 AL 7/10 D-7.769 AL 7/10 D-7.769 VD 4/14 DL-7 VD 4/14 DL-7 VD 4/20 DL-7.5 VD 4/20 DL-7.5 VL 3/13 D-5.3 VL 3/13 D-5.3 VL 4/10 D-7 VL 4/10 D-7 VL 4/10 D-7 VL 4/10 D-7 VL 4/10 D-7 VL 4/14 D-7 VL 4/14 D-7 VL 4/16 D-7.5 VL 4/16 D-7.5 VL 4/23 D-6.7 VL 4/23 D-6.7 VL 4/24 D-6.7 VL 4/24 D-6.7 VL 4/24 D-7.1 VL 4/24 D-7.1 VL 4/27 D-7.5 VL 4/27 D-7.5 VL 4/28 D-7.5 VL 4/28 D-7.5 VL 4/9 D-7 VL 4/9 D-7 VL 5/1 D-9 VL 5/1 D-9 VL 5/2 D-9 VL 5/2 D-9 VL 5/20 DC-9 VL 5/20 DC-9 HD 7/014 DGS-16 HD 7/19 DG-13 HD 7/19 DG-13 HD 7/19 DG-13 HD 7/19 DG-13 HD 7/2 DG-10	XGA32021X SET1049 XGA32021X SET1049 XGA32021X SET1049 XGA32021X SET1049 SET1301 SET1079 SET1114 SET1079 SET1114 SET1109 SET1301 SET1079 SET1301 SET1110 SET1301 SET1079 SET1114 SET1079 SET1301 SET1079 SET1301 SET1079 SET1301 SET1079 SET1114 SET1079 SET1114 SET1079 SET1301 SET1079 SET115 SET1080 SET115 SET1080 SET1080 SET1080	SET1094 SET1094 SET1025 SET1094 SET1025 SET1093		





					
<b>MERCEDES-BENZ</b>					
<b>SK 2200 SERIES</b>					
VD 4/14 DL-7 VD 4/14 DL-7 VD 4/20 DL-7.5 VD 4/20 DL-7.5 VD 4/20 DL-75 VD 4/20 DL-75 VL 3/8 D-6.5 VL 3/8 D-6.5 VL 3/8-6 VL 3/8-6 VL 3/8-6 VL 3/8-6 VL 4/10 D-7 VL 4/10 D-7 VL 4/10 D-7 VL 4/10 D-7 VL 4/10 D-7 VL 4/10 DL-7 VL 4/10 DL-7 VL 4/15 D-7.5 VL 4/15 D-7.5 VL 4/16 D-7.5 VL 4/16 D-7.5 VL 4/28 D-7.5 VL 4/28 D-7.5 VL 4/30 D-7.5 VL 4/30 D-7.5 VL 4/30 DL-7.5 VL 4/30 DL-7.5 VL 4/8 D-7 VL 4/8 D-7 VL 4/9 D-7 VL 4/9 D-7 VL 4/9 D-7 VL 4/9 D-7 VL 4/9 D-7 VL 4/9 D-7 HD 4/02 DG-10 HD 4/02 DG-10 HD 4/02 GD-10 HD 4/02 GD-10 HD 4/03 D-10 HD 4/03 D-10 HD 4/2 DG-10 HD 4/2 DG-10 HD 4/21 DG-10 HD 4/21 DG-10 HD 4/21 G-10 HD 4/21 G-10 HD 4/22 D-10 HD 4/22 D-10 HD 4/22 DG-10 HD 4/22 DG-10 HD 4/22-10	SET1301 SET1079 SET1301 SET1110 SET1114 SET1079 SET1114 SET1110 SET1114 SET1109 SET1114 SET1110 SET1301 SET1079 SET1301 SET1110 SET1301 SET1301 SET1110 SET1114 SET1079 SET1114 SET1079 SET1114 SET1079 SET1114 SET1079 SET1114 SET1079 SET1114 SET1079 SET1301 SET1110 SET1301 SET1079 SET1301 SET1110 SET1301 SET1079 SET1301 SET1110 SET1301 SET1079	SET1092 SET1103 SET1092 SET1103 SET1092 SET1103 SET1092 SET1103 SET1092 SET1103 SET1091 SET1115 SET1091 SET1115 SET1091 SET1115 SET1091 SET1115 SET1091		1278814 - 1278814 - - 1358880 - 1358880 1358881 - 1358881 - 1278814 - 1278814 - - 1278813 - 1278813 - 1278813 1278814 - 1278814 - - 1278813 - 1278813	









A



## MERCEDES-BENZ

























### SK 2200 SERIES ...

HD 4/22-10		SET1115	
HD 7/09 DG-10		SET1093	ABS — 021298
HD 7/09 DG-10		SET1049	ABS — 021298
HD 7/09 DG-10		SET1306	ABS — 021299-
HD 7/09 DG-10		SET1049	ABS — 021299-
HD 7/11 DG-9		SET1051	
HD 7/11 DG-9		SET1049	
HD 7/19 DG-13		SET1094	ABS — 021298
HD 7/19 DG-13		SET1025	ABS — 021298
HD 7/19 DG-13		SET1094	ABS — 021299-
HD 7/19 DG-13		SET1025	ABS — 021299-
HD 7/2 DG-10		SET1093	ABS — 021298
HD 7/2 DG-10		SET1049	ABS — 021298
HD 7/2 DG-10		SET1306	ABS — 021299-
HD 7/2 DG-10		SET1049	ABS — 021299-
HD 7/2 DLG-10		SET1093	ABS — 021298
HD 7/2 DLG-10		SET1049	ABS — 021298
HD 7/2 DLG-10		SET1306	ABS — 021299-
HD 7/2 DLG-10		SET1049	ABS — 021299-
HD 7/5 DG-10		SET1093	ABS — 021298
HD 7/5 DG-10		SET1049	ABS — 021298
HD 7/5 DG-10		SET1306	ABS — 021299-
HD 7/5 DG-10		SET1049	ABS — 021299-
HL 4/01 D-10		SET1092	ABS — 021298
HL 4/01 D-10		SET1103	
HL 4/01 DL-10		SET1092	
HL 4/01 DL-10		SET1103	
HL 4/01-10		SET1092	
HL 4/01-10		SET1103	
HL 4/06 D-12		SET1092	
HL 4/06 D-12		SET1103	
HL 4/06 DL-12		SET1092	
HL 4/06 DL-12		SET1103	
HL 5/2 ZL-10		SET1091	
HL 5/2 ZL-10		SET1115	
HL 7/015 D-13		SET1094	ABS — 021298
HL 7/015 D-13		SET1025	ABS — 021298
HL 7/015 D-13		SET1094	ABS — 021299-
HL 7/015 D-13		SET1025	ABS — 021299-
HL 7/015 DS-13		SET1094	ABS — 021298
HL 7/015 DS-13		SET1025	ABS — 021298
HL 7/015 DS-13		SET1094	ABS — 021299-
HL 7/015 DS-13		SET1025	ABS — 021299-
HL 7/021 D-10		SET1093	ABS — 021298
HL 7/021 D-10		SET1049	ABS — 021298
HL 7/021 D-10		SET1306	ABS — 021299-
HL 7/021 D-10		SET1049	ABS — 021299-
HL 7/021 DL-10		SET1093	ABS — 021298
HL 7/021 DL-10		SET1049	ABS — 021298
HL 7/021 DL-10		SET1306	ABS — 021299-
HL 7/021 DL-10		SET1049	ABS — 021299-
HL 7/024 DL-12.3		SET1093	
HL 7/024 DL-12.3		SET1091	
HL 7/07 D-10		SET1093	ABS — 021298
HL 7/07 D-10		SET1049	ABS — 021298







				 			
<b>MERCEDES-BENZ</b>							
<b>SK 2200 SERIES ...</b>							
HL 7/07 D-10				SET1306	I	ABS	021299-
HL 7/07 D-10				SET1049	O	ABS	021299-
HL 7/07 DL-10				SET1093	I	ABS	- 021298
HL 7/07 DL-10				SET1049	O	ABS	- 021298
HL 7/07 DL-10				SET1306	I	ABS	021299-
HL 7/07 DL-10				SET1049	O	ABS	021299-
HL 7/07 DS-10				SET1093	I	ABS	- 021298
HL 7/07 DS-10				SET1049	O	ABS	- 021298
HL 7/07 DS-10				SET1306	I	ABS	021299-
HL 7/07 DS-10				SET1049	O	ABS	021299-
HL 7/1 D-10				SET1093	I	ABS	- 021298
HL 7/1 D-10				SET1049	O	ABS	- 021298
HL 7/1 D-10				SET1306	I	ABS	021299-
HL 7/1 D-10				SET1049	O	ABS	021299-
HL 7/1 DL-10				SET1093	I	ABS	- 021298
HL 7/1 DL-10				SET1049	O	ABS	- 021298
HL 7/1 DL-10				SET1306	I	ABS	021299-
HL 7/1 DL-10				SET1049	O	ABS	021299-
HL 7/1 DL-10				SET1113	I	ABS	021299-
HL 7/1 DL-10				SET1108	O	ABS	021299-
HL 7/1 L-10				SET1093	I	ABS	- 021298
HL 7/1 L-10				SET1049	O	ABS	- 021298
HL 7/1 L-10				SET1306	I	ABS	021299-
HL 7/1 L-10				SET1049	O	ABS	021299-
HL 7/10-D9				SET1093	I	ABS	- 021298
HL 7/10-D9				SET1049	O	ABS	- 021298
HL 7/10-D9				SET1306	I	ABS	021299-
HL 7/10-D9				SET1049	O	ABS	021299-
HL 7/1-10				SET1306	I	ABS	021299-
HL 7/18 D-13				SET1094	O	ABS	- 021298
HL 7/18 D-13				SET1025	I	ABS	- 021298
HL 7/18 D-13				SET1094	O	ABS	021299-
HL 7/18 D-13				SET1025	I	ABS	021299-
HL 7/2 DG-10				SET1093	I	ABS	- 021298
HL 7/2 DG-10				SET1049	O	ABS	- 021298
HL 7/2 DG-10				SET1306	I	ABS	021299-
HL 7/2 DG-10				SET1049	O	ABS	021299-
HL 7/3 D-10				SET1093	I	ABS	- 021298
HL 7/3 D-10				SET1049	O	ABS	- 021298
HL 7/3 D-10				SET1306	I	ABS	021299-
HL 7/3 D-10				SET1049	O	ABS	021299-
HL 7/3 D-10				SET1113	I	ABS	021299-
HL 7/3 D-10				SET1108	O	ABS	021299-
HL 7/3 DL-10				SET1093	I	ABS	- 021298
HL 7/3 DL-10				SET1049	O	ABS	- 021298
HL 7/3 DL-10				SET1306	I	ABS	021299-
HL 7/3 DL-10				SET1049	O	ABS	021299-
HL 7/3 DS-10				SET1093	I	ABS	- 021298
HL 7/3 DS-10				SET1049	O	ABS	- 021298
HL 7/3 DS-10				SET1306	I	ABS	021299-
HL 7/3 DS-10				SET1049	O	ABS	021299-
HL 7/4 D-10				SET1093	I	ABS	- 021298
HL 7/4 D-10				SET1049	O	ABS	- 021298
HL 7/4 D-10				SET1306	I	ABS	021299-
HL 7/4 D-10				SET1049	O	ABS	021299-



A

				 			
<b>MERCEDES-BENZ</b>							
<b>SK 2200 SERIES ...</b>							
	NR 4/10 DL-6 NR 4/10 DL-6 NR 4/10 DL-6 NR 4/10 DL-6 NR 4/11 DL-7.5 NR 4/11 DL-7.5 NS 4/10 D-6 NS 4/10 D-6 NS 4/10 D-6.7 NS 4/10 D-6.7 NS 4/11 D-10 NS 4/11 D-10		SET1034 SET1079 SET1301 SET1079 SET1301 SET1079 SET1034 SET1079 SET1301 SET1110 SET1091 SET1115				
<b>SK 2300 SERIES</b>							
	VD 4/26 DL-7.5 VD 4/26 DL-7.5 HD 7/5 DG-10 HD 7/5 DG-10 HD 7/5 DG-10 HD 7/5 DG-10	SET1114 SET1079	SET1093 SET1049 SET1306 SET1049				 - 021298  - 021298  021299-  021299-
<b>SK 2400 SERIES</b>							
	VD 4/20 DL-7.5 VD 4/20 DL-7.5 VD 4/26DL-7.5 VD 4/26DL-7.5 VL 4/10 D-7 VL 4/10 D-7 VL 4/10 DL-7 VL 4/14 DL-7 VL 4/14 DL-7 VL 4/15 D-7.5 VL 4/16 D-7.5 VL 4/23 D-6.7 VL 4/23 D-6.7 VL 4/24 D-6.7 VL 4/24 D-6.7 VL 4/24 D-7.1 VL 4/24 D-7.1 VL 4/25 DL-6.7 VL 4/25 DL-6.7 VL 4/27 D-7.5 VL 4/27 D-7.5 VL 4/28 D-7.5 VL 4/28 D-7.5 VL 4/28 D-7.5 VL 4/28 D-7.5 VL 4/29 D-7.5 VL 4/29 D-7.5 VL 4/30 D-7.5 VL 4/30 D-7.5 VL 4/30 DL-7.5 VL 4/30 DL-7.5 VL 4/31 DL-7.5	SET1114 SET1079 SET1114 SET1079 SET1079 SET1301 SET1301 SET1301 SET1079 SET1079 SET1079 SET1301 SET1079 SET1301 SET1079 SET1301 SET1079 SET1114 SET1079 SET1301 SET1079 SET1114 SET1079 SET1114 SET1079 SET1114 SET1079 SET1114 SET1079 SET1114					 - 1278813  - 1278813   1278814 -   1278814 -  1278814 -  1278814 -  1278814 -  1278814 -  1278814 -  1278814 -   1278814 -  1278814 -









					
<b>MERCEDES-BENZ</b>					
<b>SK 2400 SERIES ...</b>					
VL 4/31 DL-7.5 VL 4/7 D-7 VL 4/7 D-7 VL 4/7 D-7 VL 4/7 D-7 VL 4/7 DL-7 VL 4/7 DL-7 VL 4/9 D-7 VL 4/9 D-7 VL 4/9 D-7 VL 5/2 D-9 VL 5/2 D-9 HD 4/21 DG-10 HD 4/21 DG-10 HD 4/22 D-10 HD 4/22 D-10 HD 7/016 DG-13 HD 7/016 DG-13 HD 7/016 DG-13 HD 7/016 DG-13 HD 7/016 DG-13 HD 7/016 DG-13 HD 7/016 DG-13 HD 7/016 DG-13 HD 7/016 DG-13 HD 7/09 DG-10 HD 7/09 DG-10 HD 7/09 DG-10 HD 7/09 DG-10 HD 7/19 DG-13 HD 7/19 DG-13 HD 7/19 DG-13 HD 7/2 DG-10 HD 7/2 DG-10 HD 7/2 DG-10 HD 7/5 DG-10 HD 7/5 DG-10 HD 7/5 DG-10 HD 7/5 DG-10 HD 7/5 DG-10 HL 4/038 D-12 HL 4/038 D-12 HL 4/039 D L-12 HL 4/039 D L-12 HL 4/039 D-12 HL 4/039 D-12 HL 4/06 D-12 HL 4/06 D-12 HL 4/06 DL-12 HL 4/06 DL-12 HL 7/015 D-13 HL 7/015 D-13 HL 7/015 D-13 HL 7/015 D-13 HL 7/016 DG-13 HL 7/021 D-10	SET1079 SET1301 SET1079 SET1301 SET1110 SET1301 SET1110 SET1301 SET1079 SET115 SET1080	SET1091 SET1115 SET1091 SET1115 SET1094 SET1025 SET1094 SET1025 SET1094 SET1094 SET1025 SET1025 SET1093 SET1049 SET1306 SET1049 SET1094 SET1025 SET1094 SET1093 SET1049 SET1306 SET1049 SET1093 SET1049 SET1306 SET1049 SET1093 SET1049 SET1306 SET1049 SET1092 SET1103 SET1092 SET1103 SET1092 SET1103 SET1092 SET1103 SET1092 SET1103 SET1092 SET1093		1278814 - 1278814 - - 1278813 - 1278813 1278814 - - 1278813 1278814 - 1278814 -	ABS - 021298 ABS - 021298 ABS - 021299- ABS - 021299- ABS - 021298 ABS - 021299- ABS - 021298 ABS - 021299- ABS - 021298 ABS - 021299- ABS - 021298 ABS - 021298 ABS - 021299- ABS - 021299- ABS - 021298 ABS - 021298 ABS - 021299- ABS - 021299- ABS - 021298 ABS - 021298 ABS - 021299- ABS - 021299- ABS - 021298 ABS - 021298 ABS - 021299- ABS - 021299- ABS - 021298 ABS - 021298 ABS - 021299- ABS - 021299- ABS - 021298 ABS - 021298 ABS - 021299- ABS - 021299- ABS - 021298



A







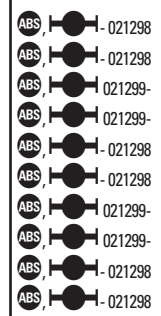









































































<b>MERCEDES-BENZ</b>											
<b>SK 2400 SERIES ...</b>											
	HL 7/021 D-10			SET1049							
	HL 7/021 D-10			SET1306							
	HL 7/021 D-10			SET1049							
	HL 7/024 D-12.3			SET1093							
	HL 7/024 D-12.3			SET1091							
	HL 7/024 DL-12.3			SET1093							
	HL 7/024 DL-12.3			SET1091							
	HL 7/025 D-12.3			SET1093							
	HL 7/025 D-12.3			SET1091							
	HL 7/026 D-12.3			SET1093							
	HL 7/026 D-12.3			SET1091							
	HL 7/026 DL-12.3			SET1093							
	HL 7/026 DL-12.3			SET1091							
	HL 7/07 D-10			SET1093							
	HL 7/07 D-10			SET1049							
	HL 7/07 D-10			SET1306							
	HL 7/07 D-10			SET1049							
	HL 7/07 D-11.5			SET1093							
	HL 7/07 D-11.5			SET1049							
	HL 7/07 D-11.5			SET1306							
	HL 7/07 D-11.5			SET1049							
	HL 7/07 DL-11.5			SET1093							
	HL 7/07 DL-11.5			SET1049							
	HL 7/07 DL-10			SET1093							
	HL 7/07 DL-10			SET1049							
	HL 7/07 DL-10			SET1306							
	HL 7/07 DL-10			SET1049							
	HL 7/07 DL-11.5			SET1306							
	HL 7/07 DL-11.5			SET1049							
	HL 7/126 DL-12.3			SET1306							
	HL 7/126 DL-12.3			SET1049							
	HL 7/15DL-13			SET1094							
	HL 7/15DL-13			SET1025							
	HL 7/15DL-13			SET1094							
	HL 7/15DL-13			SET1025							
	HL 7/26 D-12.3			SET1091							
	HL 7/26 DL-12.3			SET1093							
	HL 7/26 DL-12.3			SET1049							
	HL 7/26 DL-12.3			SET1306							
	HL 7/26 DL-12.3			SET1091							
	HL 7/3 D-10			SET1093							
	HL 7/3 D-10			SET1049							
	HL 7/3 D-10			SET1306							
	HL 7/3 D-10			SET1049							
	HL 7/4 D-10			SET1093							
	HL 7/4 D-10			SET1049							
	HL 7/4 D-10			SET1306							
	HL 7/4 D-10			SET1049							
	NL 4/11 DL-7.5			SET1301							
	NL 4/11 DL-7.5			SET1079							
	NS 4/10 D-6.7			SET1301							
	NS 4/10 D-6.7			SET1110							
	NS 4/11 D-10			SET1091							
	NS 4/11 D-10			SET1115							

											
<b>MERCEDES-BENZ</b>											
<b>SK 2500 SERIES</b>											
VD 4/26DL-7.5		SET1114									
VD 4/26DL-7.5		SET1079									
VL 4/10 D-7		SET1301									
VL 4/10 D-7		SET1079									
VL 4/16 D-7.5		SET1114									
VL 4/16 D-7.5		SET1079									
VL 4/23 D-6.7		SET1301									
VL 4/23 D-6.7		SET1079									
VL 4/24 D-6.7		SET1301									
VL 4/24 D-6.7		SET1079									
VL 4/25 DL-6.7		SET1301									
VL 4/25 DL-6.7		SET1079									
VL 4/27 D-7.5		SET1114									
VL 4/27 D-7.5		SET1079									
VL 4/28 D-7.5		SET1114									
VL 4/28 D-7.5		SET1079									
VL 4/28 D-7.5		SET1301									
VL 4/28 D-7.5		SET1079									
VL 4/29 D-7.5		SET1114									
VL 4/29 D-7.5		SET1079									
VL 4/30 D-7.5		SET1114									
VL 4/30 D-7.5		SET1079									
VL 4/30 DL-7.5		SET1114									
VL 4/30 DL-7.5		SET1079									
VL 4/31 D L-7		SET1301									
VL 4/31 D L-7		SET1079									
VL 4/31 DL-7.5		SET1114									
VL 4/31 DL-7.5		SET1079									
VL 4/36 D-6.7		SET1301									
VL 4/36 D-6.7		SET1079									
VL 5/1 D-9		SET115									
VL 5/1 D-9		SET1080									
VL 5/2 D-9		SET115									
VL 5/2 D-9		SET1080									
VL 5/21 DC-9		SET1080									
VL 5/21 DC-9		SET1080									
HD 4/02 DG-10				SET1092							
HD 4/02 DG-10				SET1103							
HD 4/03 D-10				SET1092							
HD 4/03 D-10				SET1103							
HD 4/21 DG-10				SET1091							
HD 4/21 DG-10				SET1115							
HD 4/22 D-10				SET1091							
HD 4/22 D-10				SET1115							
HD 7/09 DG-10				SET1093							
HD 7/09 DG-10				SET1049							
HD 7/09 DG-10				SET1306							
HD 7/09 DG-10				SET1049							
HD 7/19 DG-13				SET1094							
HD 7/19 DG-13				SET1025							
HD 7/19 DG-13				SET1094							
HD 7/19 DG-13				SET1025							
HD 7/2 DG-10				SET1093							
HD 7/2 DG-10				SET1049							





















				 			
<b>MERCEDES-BENZ</b>							
<b>SK 2500 SERIES ...</b>							
	HL 7/07 DL-11.5		SET1094		 - 021298		
	HL 7/07 DL-11.5		SET1025		 - 021298		
	HL 7/07 DL-11.5		SET1094		 021299-		
	HL 7/07 DL-11.5		SET1025		 021299-		
	HL 7/07 DL-11.5		SET1093		 - 021298		
	HL 7/07 DL-11.5		SET1049		 - 021298		
	HL 7/07 DL-11.5		SET1306		 - 021299-		
	HL 7/07 DL-11.5		SET1049		 - 021299-		
	HL 7/15D-13		SET1094		 - 021298		
	HL 7/15D-13		SET1025		 - 021298		
	HL 7/15D-13		SET1094		 - 021299-		
	HL 7/15D-13		SET1025		 021299-		
	HL 7/18 D-13		SET1094		 - 021298		
	HL 7/18 D-13		SET1025		 - 021298		
	HL 7/18 D-13		SET1094		 021299-		
	HL 7/18 D-13		SET1025		 021299-		
	HL 7/3 D-10		SET1093		 - 021298		
	HL 7/3 D-10		SET1049		 - 021298		
	HL 7/3 D-10		SET1306		 021299-		
	HL 7/3 D-10		SET1049		 021299-		
	HL 7/4 D-10		SET1093		 - 021298		
	HL 7/4 D-10		SET1049		 - 021298		
	HL 7/4 D-10		SET1306		 021299-		
	HL 7/4 D-10		SET1049		 021299-		
	NR 4/11 DL-7.5		SET1301				
	NR 4/11 DL-7.5		SET1079				
	NS 4/10 D-6.7		SET1301				
	NS 4/10 D-6.7		SET1110				
	NS 4/11 D-10		SET1091				
	NS 4/11 D-10		SET1115				
<b>SK 2600 SERIES</b>							
	VD 4/14 DL-7		SET1301				
	VD 4/14 DL-7		SET1079				
	VD 4/20 DL-7.5		SET1114				
	VD 4/20 DL-7.5		SET1079				
	VD 4/26 DL-7.5		SET1114				
	VD 4/26 DL-7.5		SET1079				
	VL 4/10 D-7		SET1301				
	VL 4/10 D-7		SET1079				
	VL 4/10 D-7		SET1301				
	VL 4/10 D-7		SET1301				
	VL 4/10 D-7		SET1079				
	VL 4/15 D-7.5		SET1079				
	VL 4/16 D-7.5		SET1079				
	VL 4/19 D-7.5		SET1079				
	VL 4/23 D-6.7		SET1301				
	VL 4/23 D-6.7		SET1079				
	VL 4/24 D-6.7		SET1301				
	VL 4/24 D-6.7		SET1079				
	VL 4/25 DL-6.7		SET1301				
	VL 4/25 DL-6.7		SET1079				
	VL 4/27 D-7.5		SET1114				
	VL 4/27 D-7.5		SET1079				
					 - 1278813		
					 1278814 -		
					 1278814 -		

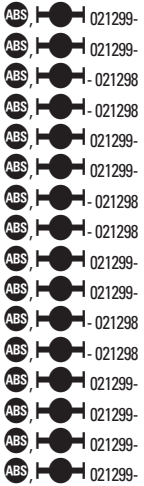

A

					
<b>MERCEDES-BENZ</b>					
<b>SK 2600 SERIES ...</b>					
VL 4/28 D-7.5 VL 4/28 D-7.5 VL 4/29 D-7.5 VL 4/29 D-7.5 VL 4/31 DL-7.5 VL 4/31 DL-7.5 VL 4/7 D-7 VL 4/7 D-7 VL 4/7 D-7 VL 4/7 D-7 VL 4/7 D-7 VL 4/8 D-7 VL 4/8 D-7 VL 4/8 D-7 VL 4/9 D-7 VL 4/9 D-7 VL 4/9 D-7 VL 4/9-D7 VL 4/9-D7 VL 5/1 D-9 VL 5/1 D-9 VL 5/2 D-9 VL 5/2 D-9 HD 4/02 DG-10 HD 4/02 DG-10 HD 4/03 D-10 HD 4/03 D-10 HD 7/014 DGS-16 HD 7/016 DG-13 HD 7/016 DG-13 HD 7/016 DG-13 HD 7/016 DG-13 HD 7/19 DG-13 HD 7/19 DG-13 HD 7/19 DG-13 HD 7/19 DG-13 HD 7/2 DG-10 HD 7/2 DG-10 HD 7/2 DG-10 HD 7/2 DG-10 HL 4/01 DL-10 HL 4/01 DL-10 HL 7/013 D-16 HL 7/015 D-13 HL 7/015 D-13 HL 7/015 D-13 HL 7/015 D-13 HL 7/015 DL-13 HL 7/015 DL-13 HL 7/015 DL-13 HL 7/015 DL-13 HL 7/07 D-10 HL 7/07 D-10 HL 7/07 D-10 HL 7/07 D-10 HL 7/1-10 HL 7/1-10	SET1114 SET1079 SET1114 SET1079 SET1114 SET1079 SET1301 SET1079 SET1301 SET1110 SET1301 SET1110 SET1301 SET1110 SET1301 SET1110 SET1301 SET1079 SET1115 SET1080 SET1115 SET1080  SET1092 SET1103 SET1092 SET1103 SET1094 SET1094 SET1025 SET1094 SET1025 SET1094 SET1025 SET1094 SET1025 SET1093 SET1049 SET1306 SET1049 SET1092 SET1103 SET1094 SET1094 SET1025 SET1094 SET1025 SET1094 SET1025 SET1093 SET1049 SET1306 SET1049 SET1093 SET1049 SET1093 SET1049				1278814 - 1278814 - - 1278813 - 1278813 - 1278813 - 1278813 - 1278813 - 1278813 - 1278813 - 1278813 - 1278813 - 1278813 - 1278813 - 1278814 - - 1278814 - ABS - 021298 ABS - 021298 ABS - 021299- ABS - 021299- ABS - 021298 ABS - 021298 ABS - 021299- ABS - 021299- ABS - 021298 ABS - 021298 ABS - 021299- ABS - 021299- ABS - 021298 ABS - 021298 ABS - 021299- ABS - 021299- ABS - 021298 ABS - 021298 ABS - 021299- ABS - 021299- ABS - 021298 ABS - 021298 ABS - 021299- ABS - 021299- ABS - 021298 ABS - 021298 ABS - 021299- ABS - 021299- ABS - 021298 ABS - 021298 ABS - 021299- ABS - 021299- ABS - 021298 ABS - 021298

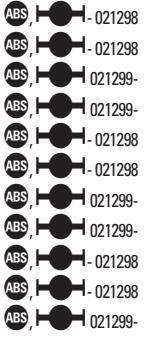
					
<b>MERCEDES-BENZ</b>					
<b>SK 2600 SERIES ...</b>					
	HL 7/1-10 HL 7/1-10 HL 7/18 D-13 HL 7/18 D-13 HL 7/18 D-13 HL 7/18 D-13 HL 7/18 DS-13 HL 7/18 DS-13 HL 7/18 DS-13 HL 7/18 DS-13 HL 7/3 D-10 HL 7/3 D-10 HL 7/3 D-10 HL 7/3 D-10 HL 7/3 D-10 HL 7/3 D-10		SET1306 SET1049 SET1094 SET1025 SET1094 SET1025 SET1094 SET1025 SET1094 SET1025 SET1094 SET1025 SET1093 SET1049 SET1306 SET1049 SET1113 SET1108		
<b>SK 2800 SERIES</b>					
	VD 4/20 DL-7.5 VD 4/20 DL-7.5 VL 4/10 D-7 VL 4/10 D-7 VL 4/16 D-7.5 VL 4/16 D-7.5	SET1301 SET1110 SET1301 SET1079 SET1114 SET1079			
<b>SK 3000 SERIES</b>					
	VD 4/20 DL-7.5 VD 4/20 DL-7.5 VD 4/20 DL-7.5 VD 4/20 DL-7.5 VL 4/10 D-7 VL 4/10 D-7 VL 4/15 D-7.5 VL 4/15 D-7.5 VL 4/16 D-7.5 VL 4/16 D-7.5 VL 4/27 D-7.5 VL 4/27 D-7.5 VL 4/9 D-7 VL 4/9 D-7 VL 5/2 D-9 VL 5/2 D-9 HD 7/014 DGS-16 HD 7/016 DG-13 HD 7/016 DG-13 HD 7/016 DG-13 HD 7/016 DG-13 HD 7/2 DG-10 HD 7/2 DG-10 HD 7/2 DG-10 HD 7/2 DG-10 HD 7/5 DG-10 HD 7/5 DG-10 HD 7/5 DG-10	SET1301 SET1110 SET1114 SET1079 SET1301 SET1079 SET1114 SET1079 SET1114 SET1079 SET1114 SET1079 SET1301 SET1079 SET115 SET1111	SET1094 SET1094 SET1025 SET1094 SET1025 SET1093 SET1049 SET1306 SET1049 SET1093 SET1049 SET1306		





A

<b>MERCEDES-BENZ</b>					
<b>SK 3000 SERIES ...</b>					
	HD 7/5 DG-10 HL 7/013 D-16 HL 7/015 D-13 HL 7/015 D-13 HL 7/015 D-13 HL 7/015 D-13 HL 7/015 D-13 HL 7/3 D-10 HL 7/3 D-10 HL 7/3 D-10 HL 7/3 D-10 HL 7/4 D-10 HL 7/4 D-10 HL 7/4 D-10 HL 7/4 D-10		SET1049 SET1094 SET1094 SET1025 SET1094 SET1025 SET1093 SET1049 SET1306 SET1049 SET1093 SET1049 SET1306 SET1049		
<b>SK 3200 SERIES</b>					
	AL 7/1 D-7 AL 7/1 D-7 VD 4/20 DL-7.5 VD 4/20 DL-7.5 VL 4/10 D-7 VL 4/10 D-7 VL 4/15 D-7.5 VL 4/15 D-7.5 VL 4/16 D-7.5 VL 4/16 D-7.5 VL 4/23 D-6.7 VL 4/23 D-6.7 VL 4/24 D-6.7 VL 4/24 D-6.7 VL 4/25 DL-6.7 VL 4/25 DL-6.7 VL 4/27 D-7.5 VL 4/27 D-7.5 VL 4/28 D-7.5 VL 4/28 D-7.5 VL 4/29 D-7.5 VL 4/29 D-7.5 VL 4/30 D-7.5 VL 4/30 D-7.5 VL 4/30 DL-7.5 VL 4/30 DL-7.5 VL 4/31 DL-7.5 VL 4/31 DL-7.5 HD 7/014 DG-16 HD 7/014 DGS-16 HD 7/016 DG-13 HD 7/016 DG-13 HD 7/016 DG-13 HD 7/016 DG-13 HD 7/19 DG-13 HD 7/19 DG-13 HD 7/19 DG-13 HD 7/19 DG-13	XGA32021X SET1049 SET1114 SET1079 SET1301 SET1079 SET1114 SET1079 SET1114 SET1079 SET1114 SET1079 SET1301 SET1079 SET1301 SET1079 SET1114 SET1079 SET1114 SET1079 SET1114 SET1079 SET1114 SET1079 SET1114 SET1079 SET1114 SET1079 SET1114 SET1079	SET1094 SET1094 SET1094 SET1025 SET1094 SET1025 SET1094 SET1025 SET1094 SET1025 SET1094 SET1025 SET1094 SET1025		



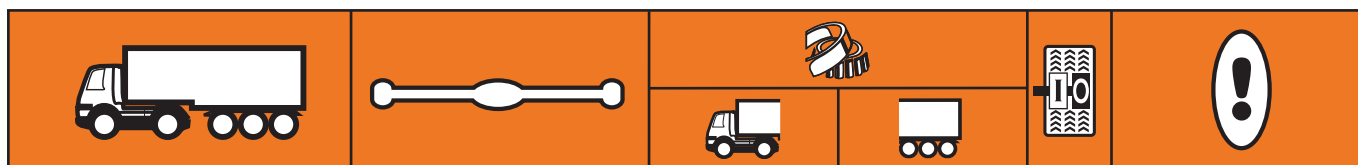

**MERCEDES-BENZ**  
**SK 3200 SERIES ...**

HD 7/2 DG-10		SET1093	I	ABS	- 021298
HD 7/2 DG-10		SET1049	O	ABS	- 021298
HD 7/2 DG-10		SET1306	I	ABS	021299-
HD 7/2 DG-10		SET1049	O	ABS	021299-
HD 7/5 DG-10		SET1093	I	ABS	- 021298
HD 7/5 DG-10		SET1049	O	ABS	- 021298
HD 7/5 DG-10		SET1306	I	ABS	021299-
HD 7/5 DG-10		SET1049	O	ABS	021299-
HL 4/06 D-12		SET1092	I		
HL 4/06 D-12		SET1103	O		
HL 7/013 D-16		SET1094	I		
HL 7/015 D-13		SET1094	O	ABS	- 021298
HL 7/015 D-13		SET1025	I	ABS	- 021298
HL 7/015 D-13		SET1094	O	ABS	021299-
HL 7/015 D-13		SET1025	I	ABS	021299-
HL 7/015 DL-13		SET1094	O	ABS	- 021298
HL 7/015 DL-13		SET1025	I	ABS	- 021298
HL 7/015 DL-13		SET1094	O	ABS	021299-
HL 7/015 DL-13		SET1025	I	ABS	021299-
HL 7/18 D-13		SET1094	O	ABS	- 021298
HL 7/18 D-13		SET1025	I	ABS	- 021298
HL 7/18 D-13		SET1094	O	ABS	021299-
HL 7/18 D-13		SET1025	I	ABS	021299-
HL 7/3 D-10		SET1093	I	ABS	- 021298
HL 7/3 D-10		SET1049	O	ABS	- 021298
HL 7/3 D-10		SET1306	I	ABS	021299-
HL 7/3 D-10		SET1049	O	ABS	021299-
HL 7/4 D-10		SET1093	I	ABS	- 021298
HL 7/4 D-10		SET1049	O	ABS	- 021298
HL 7/4 D-10		SET1306	I	ABS	021299-
HL 7/4 D-10		SET1049	O	ABS	021299-
NR 4/11 DL-7.5		SET1301	I		
NR 4/11 DL-7.5		SET1079	O		
NS 4/11 D-10		SET1091	I		
NS 4/11 D-10		SET1115	O		

**SK 3300 SERIES**

AL 7/1 D-7	XGA32021X		I		
AL 7/1 D-7	SET1049		O		
VD 4/20 DL-7.5	SET1301		I		
VD 4/20 DL-7.5	SET1079		O		
VL 4/10 D-7	SET1301		I		
VL 4/10 D-7	SET1079		O		
VL 4/15 D-7.5	SET1114		I		
VL 4/15 D-7.5	SET1079		O		
VL 4/16 D-7.5	SET1114		I		
VL 4/16 D-7.5	SET1079		O		
VL 4/16 D-7.5	SET1114		I		
VL 4/20 DL-7.5	SET1114		O		
VL 4/20 DL-7.5	SET1079		I		
VL 4/27 D-7.5	SET1079		O		
VL 5/1 D-9	SET1080		I		
VL 5/1 D-9	SET1080		O		
VL 5/2 D-9	SET115		I		

APPLICATION LISTINGS - TRUCK

A



**MERCEDES-BENZ**

**SK 3300 SERIES ...**

VL 5/2 D-9	SET1080			○	
VL 5/20 DC-9	SET1080			○	
VL 5/20 DC-9	SET1080			○	
VL 5/21 DC-9	SET1080			○	
VL 5/21 DC-9	SET1080			○	
HD 7/016 DG-13		SET1094		○	ABS 2 - 021298
HD 7/016 DG-13		SET1025		○	ABS 2 - 021298
HD 7/016 DG-13		SET1094		○	ABS 2 - 021299-
HD 7/016 DG-13		SET1025		○	ABS 2 - 021299-
HD 7/19 DG-13		SET1094		○	ABS 2 - 021298
HD 7/19 DG-13		SET1025		○	ABS 2 - 021298
HD 7/19 DG-13		SET1094		○	ABS 2 - 021299-
HD 7/19 DG-13		SET1025		○	ABS 2 - 021299-
HD 7/2 DG-10		SET1093		○	ABS 2 - 021298
HD 7/2 DG-10		SET1049		○	ABS 2 - 021298
HD 7/2 DG-10		SET1306		○	ABS 2 - 021299-
HD 7/2 DG-10		SET1049		○	ABS 2 - 021299-
HL 7/015 D-13		SET1094		○	ABS 2 - 021298
HL 7/015 D-13		SET1025		○	ABS 2 - 021298
HL 7/015 D-13		SET1094		○	ABS 2 - 021299-
HL 7/015 D-13		SET1025		○	ABS 2 - 021299-
HL 7/016 DG-13		SET1094		○	ABS 2 - 021298
HL 7/016 DG-13		SET1025		○	ABS 2 - 021298
HL 7/016 DG-13		SET1094		○	ABS 2 - 021299-
HL 7/016 DG-13		SET1025		○	ABS 2 - 021299-
HL 7/18 D-13		SET1094		○	ABS 2 - 021298
HL 7/18 D-13		SET1025		○	ABS 2 - 021298
HL 7/18 D-13		SET1094		○	ABS 2 - 021299-
HL 7/18 D-13		SET1025		○	ABS 2 - 021299-
HL 7/3 D-10		SET1093		○	ABS 2 - 021298
HL 7/3 D-10		SET1049		○	ABS 2 - 021298
HL 7/3 D-10		SET1306		○	ABS 2 - 021299-
HL 7/3 D-10		SET1049		○	ABS 2 - 021299-

**SK 3500 SERIES**

AL 7/1 D-7	XGA32021X			○	
AL 7/1 D-7	SET1049			○	
VL 4/10 D-7	SET1301			○	
VL 4/10 D-7	SET1079			○	
VL 4/15 D-7.5	SET1114			○	
VL 4/15 D-7.5	SET1079			○	
VL 4/16 D-7.5	SET1114			○	
VL 4/16 D-7.5	SET1079			○	
VL 4/20 DL-7.5	SET1114			○	
VL 4/20 DL-7.5	SET1079			○	
VL 4/23 D-6.7	SET1301			○	
VL 4/23 D-6.7	SET1079			○	
VL 4/24 D-6.7	SET1301			○	
VL 4/24 D-6.7	SET1079			○	
VL 4/25 DL-6.7	SET1301			○	
VL 4/25 DL-6.7	SET1079			○	
VL 4/27 D-7.5	SET1114			○	
VL 4/27 D-7.5	SET1079			○	
VL 4/28 D-7.5	SET1114			○	

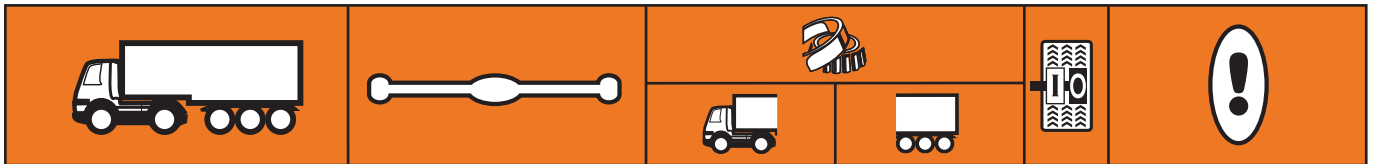

**MERCEDES-BENZ**













**SK 3500 SERIES ...**





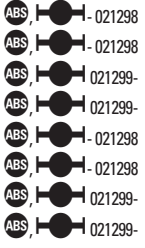





VL 4/28 D-7.5	SET1079				
VL 4/29 D-7.5	SET1114				
VL 4/29 D-7.5	SET1079				
VL 4/31 DL-7.5	SET1114				
VL 4/31 DL-7.5	SET1079				
VL 5/1 D-9	SET115				
VL 5/1 D-9	SET1111				
VL 5/2 D-9	SET115				
VL 5/2 D-9	SET1111				
VO 4/22 DLE-6.6	SET1301				
VO 4/22 DLE-6.6	SET1079				
HD 7/014 DGS-16		SET1094			
HD 7/016 DG-13		SET1094			
HD 7/016 DG-13		SET1025			
HD 7/016 DG-13		SET1094			
HD 7/016 DG-13		SET1025			
HD 7/016 DG-13		SET1094			
HD 7/19 DG-13		SET1025			
HD 7/19 DG-13		SET1094			
HD 7/19 DG-13		SET1025			
HD 7/19 DG-13		SET1094			
HD 7/19 DG-13		SET1025			
HL 7/013 D-16		SET1094			
HL 7/015 D-13		SET1094			
HL 7/015 D-13		SET1025			
HL 7/015 D-13		SET1094			
HL 7/015 D-13		SET1025			
HL 7/015 DL-13		SET1094			
HL 7/015 DL-13		SET1025			
HL 7/015 DL-13		SET1094			
HL 7/015 DL-13		SET1025			
HL 7/016 DG-13		SET1094			
HL 7/016 DG-13		SET1025			
HL 7/016 DG-13		SET1094			
HL 7/016 DG-13		SET1025			
HL 7/18 D-13		SET1094			
HL 7/18 D-13		SET1025			
HL 7/18 D-13		SET1094			
HL 7/18 D-13		SET1025			
NR 4/11 DL-7.5		SET1301			
NR 4/11 DL-7.5		SET1079			

**SK 3600 SERIES**

VD 4/20 DL-7.5	SET1114				
VD 4/20 DL-7.5	SET1079				
VL 4/10 D-7	SET1301				
VL 4/10 D-7	SET1079				
VL 4/16 D-7.5	SET1114				
VL 4/16 D-7.5	SET1079				
HD 7/19 DG-13		SET1094			
HD 7/19 DG-13		SET1025			
HD 7/19 DG-13		SET1094			
HD 7/19 DG-13		SET1025			



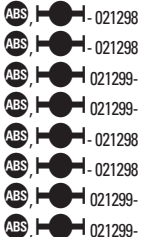





A





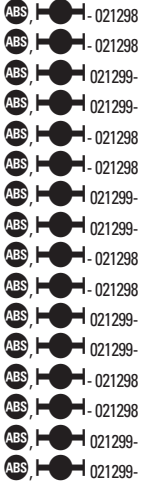

					
<b>MERCEDES-BENZ</b>					
<b>SK 3800 SERIES</b>					
	VD 4/20 DL-7.5 VD 4/20 DL-7.5 VL 4/16 D-7.5 VL 4/16 D-7.5 HD 7/014 DG-16 HD 7/014 DGS-16 HL 7/013 D-16	SET1114 SET1079 SET1114 SET1079	SET1094 SET1094 SET1094		
<b>SK 4000 SERIES</b>					
	VL 4/10 D-7 VL 4/10 D-7 VL 4/16 D-7.5 VL 4/16 D-7.5 HD 7/013 D-16 HD 7/014 DGS-16 HD 7/016 DG-13 HD 7/016 DG-13 HD 7/016 DG-13 HD 7/016 DG-13 HL 7/015 D-13 HL 7/015 D-13 HL 7/015 D-13 HL 7/015 D-13	SET1301 SET1079 SET1114 SET1079	SET1094 SET1094 SET1094 SET1025 SET1094 SET1025 SET1094 SET1025 SET1094 SET1025 SET1094 SET1025		
<b>SK 4100 SERIES</b>					
	VL 4/27 D-7.5 VL 4/27 D-7.5 VL 4/53 DC-7.5 VL 4/53 DC-7.5 VL 4/55 D-7.5 VL 4/55 D-7.5 VL 5/1 D-9 VL 5/1 D-9 HD 4/02 GD-10 HD 4/02 GD-10 HD 4/03 D-10 HD 4/03 D-10 HD 7/016 DG-13 HD 7/016 DG-13 HD 7/016 DG-13 HD 7/016 DG-13 HL 7/015 D L-13 HL 7/015 D L-13 HL 7/015 D L-13 HL 7/015 D L-13	SET1114 SET1079 SET1114 SET1079 SET1114 SET1079 SET1080 SET1080	SET1092 SET1103 SET1092 SET1103 SET1094 SET1025 SET1094 SET1025 SET1094 SET1025 SET1094 SET1025		
<b>SK 4400 SERIES</b>					
	AL 7/1 D-7 AL 7/1 D-7 VL 4/10 D-7 VL 4/10 D-7 VL 4/15 D-7.5 VL 4/15 D-7.5 VL 4/16 D-7.5	XGA32021X SET1049 SET1301 SET1079 SET1114 SET1079 SET1114			

					
<b>MERCEDES-BENZ</b>					
<b>SK 4400 SERIES ...</b>					
	VL 4/16 D-7.5 VL 4/25 DL-6.7 VL 4/25 DL-6.7 VL 4/27 D-7.5 VL 4/27 D-7.5 VL 4/28 D-7.5 VL 4/28 D-7.5 VL 4/28 D-7.5 VL 5/1 D-9 VL 5/1 D-9 VL 5/2 D-9 VL 5/2 D-9 VL 5/2 D-9 HD 7/016 DG-13 HD 7/016 DG-13 HD 7/016 DG-13 HD 7/016 DG-13	SET1079 SET1301 SET1079 SET1114 SET1079 SET1114 SET1079 SET1114 SET1079 SET1115 SET1111 SET115 SET1111	SET1094 SET1025 SET1094 SET1025		 ABS - 021298 ABS - 021298 ABS - 021299- ABS - 021299-
<b>SK 4800 SERIES</b>					
	VL 4/10 D-7 VL 4/10 D-7 VL 4/15 D-7.5 VL 4/15 D-7.5 VL 4/16 D-7.5 VL 4/16 D-7.5 VL 4/27 D-7.5 VL 4/27 D-7.5 VL 5/1 D-9 VL 5/1 D-9 VL 5/2 D-9 VL 5/2 D-9 VL 5/2 D-9 HD 7/016 DG-13 HD 7/016 DG-13 HD 7/016 DG-13 HD 7/016 DG-13 HL 7/015 D-13 HL 7/015 D-13 HL 7/015 D-13 HL 7/015 D-13	SET1301 SET1079 SET1114 SET1079 SET1114 SET1079 SET1114 SET1079 SET1114 SET1079 SET1115 SET1111 SET115 SET1111 SET1115 SET1111	SET1094 SET1025 SET1094 SET1025 SET1094 SET1025 SET1094 SET1025 SET1094 SET1025		 ABS - 021298 ABS - 021298 ABS - 021299- ABS - 021299- ABS - 021298 ABS - 021298 ABS - 021299- ABS - 021299-
<b>SK 5000 SERIES</b>					
	VL 4/10 D-7 VL 4/10 D-7 VL 4/15 D-7.5 VL 4/15 D-7.5 VL 4/16 D-7.5 VL 4/16 D-7.5 VL 4/23 D-6.7 VL 4/23 D-6.7 VL 4/24 D-6.7 VL 4/24 D-6.7 VL 4/27 D-7.5 VL 4/27 D-7.5 VL 4/28 D-7.5 VL 4/28 D-7.5 VL 5/1 D-9	SET1301 SET1079 SET1114 SET1079 SET1114 SET1079 SET1301 SET1079 SET1301 SET1079 SET1114 SET1079 SET1114 SET1079 SET115			



A

					
<p><b>MERCEDES-BENZ</b></p>					
<p><b>SK 5000 SERIES ...</b></p>					
	VL 5/1 D-9 VL 5/2 D-9 VL 5/2 D-9 HD 7/014 DGS-16 HD 7/016 DG-13 HD 7/016 DG-13 HD 7/016 DG-13 HD 7/016 DG-13 HD 7/19 DG-13 HD 7/19 DG-13 HD 7/19 DG-13 HD 7/19 DG-13 HD 7/19 DG-13 HL 7/015 DL-13 HL 7/015 DL-13 HL 7/015 DL-13 HL 7/015 DL-13 HL 7/18 D-13 HL 7/18 D-13 HL 7/18 D-13 HL 7/18 D-13	SET1111 SET115 SET1111	SET1094 SET1094 SET1025 SET1094 SET1025 SET1094 SET1025 SET1094 SET1025 SET1094 SET1025 SET1094 SET1025 SET1094 SET1025 SET1094 SET1025 SET1094 SET1025 SET1094 SET1025 SET1094 SET1025 SET1094 SET1025		
<p><b>SK 6000 SERIES</b></p>					
	VL 4/10 D-7 VL 4/10 D-7 VL 4/15 D-7.5 VL 4/15 D-7.5 VL 4/16 D-7.5 VL 4/16 D-7.5	SET1301 SET1079 SET1114 SET1079 SET1079			
<p><b>T2 600 SERIES</b></p>					
	VL 1/3-2.1 VL 1/3-2.1 VL 1/3-2.1 VL 1/3-2.1 VL 1/5-2.3 VL 1/5-2.3 VL 1/6-2.3 VL 1/6-2.3 VL 1/7-2.6 VL 1/7-2.6 VL 1/9 C-2.3 VL 1/9 C-2.3 VL 2/5-2.2 VL 2/5-2.2 VL 2/6-3.1 VL 2/6-3.1 HL 0/6-3.9 HL 0/6-3.9 HL 1/3-4.5 HL 1/3-4.5 HL 1/8-4.7 HL 1/8-4.7 HL 2/15-5/8 HL 2/2 L-4.8	2789/2720 SET226 SET1097 33205 SET1097 33205 SET1097 33205 SET1097 33205 SET1097 33205 SET1097 33205 SET1041 32206 SET1098 SET1074	SET1042 32210 SET272 SET98 SET1044 SET1041 SET1086 SET98		-Ch.48630 -Ch.48630 Ch.48631- Ch.48631-

											
<b>MERCEDES-BENZ</b>											
<b>T2 600 SERIES ...</b>											
	HL 2/2 L-4.8 HL 2/2-4.8 HL 2/2-4.8 HL 2/5-4.5 HL 2/5-4.5 HL 2/9-4.7 HL 2/9-4.7			SET272 SET98 SET272 SET98 SET272 SET98 SET272							
<b>NISSAN</b>											
<b>M 100.1/2</b>											
			SET1075		SET1089						
<b>M 110/125/125 T</b>											
			SET1019 SET1075		SET1089						
<b>M 125.1</b>											
			SET1019 SET1075		SET1089						
<b>M 130/130 HD, M 140</b>											
			HM212044/10 3880/3820		SET1101						
<b>MF 100/108</b>											
			SET1018 SET1018		SET1015 30205						
<b>MF 260/265</b>											
			SET54 LM67048/LM67010		SET262 SET365						
<b>P 137</b>											
			HM212044/10 3880/3820		SET401 560/552A						
<b>P 160/170 T</b>											
			H414245X/H414210 455/453X		SET1068 SET1024						









# APPLICATION LISTINGS - TRUCK



<b>NISSAN</b>											
<b>P 200/260/270/320</b>											
		6461A/6420 SET1079		SET1068 SET1024							
<b>RENAULT RVI</b>											
<b>75.130/85.150/85.130 [4X4]</b>											
	SINPAR/MD 3000 SINPAR/MD 3000 SINPAR/MD 3000 SINPAR/MD 3000 SINPAR/MD 4000 SINPAR/MD 4000 3 MRDIF 155/156/158/171/214 3 MRDIF 155/156/158/171/214 3 MRDIF 216/219 3 MRDIF 216/219 3 MRDIF 8274 3 MRDIF 8274 3 MRDIS 8500 FW 3 MRDIS 8500 FW P 620 D1 P 620 F P 620 F P 1021 K P 1021 K	SET1089 SET1045 SET1088 SET1044 SET1048 SET1048 SET1047 SET1045 SET1047 SET1045 SET1047 SET1045 SET1047 SET1047 SET1047 SET1047 SET1047 SET1047 SET1047 SET1088 SET1090 SET1089 594/593X SET1066				6 M75, - 05/91 6 M75, - 05/91 6 M70, - 05/91 6 M70, - 05/91 -05/91 -05/91 -05/91 -05/91 -05/91 -05/91 -05/91 -05/91 -05/91 -05/91 -05/91 -05/91 -05/91 -05/91 -05/91 -05/91 -05/91 -05/91 -05/91					
<b>85.150 [4X4]</b>											
	E 408-5 E 408-5 P 821/P 1021 P 821/P 1021	SET1111 SET1108		594/593X 594/593X							
<b>90 B6/B6A/B6Z/B7</b>											
	669-01 669-01 70 HD 70 HD	SET1109 32206 SET1109 SET1106		SET1088 SET1087 SET1088 SET1087			-14/06/85 -14/06/85 17/06/85 - 17/06/85 -				
<b>90 B 8</b>											
	401 401 SOMA 95 SOMA 95	32210 32207		SET1089 33013							





















				 			
<b>RENAULT RVI</b>							
<b>110.130 [6X6]</b>							
	MDRFP 4000	SET1088					
	MDRFP 4000	SET1044					
	MDRFP 4000			SET1088			
	MDRFP 4000			SET1044			
<b>110.150 [4X4]</b>							
	E 408-5	SET1111					
	E 408-5	SET1108					
	SINPAR MD 3000	SET1089					6 M75, - 05/91
	SINPAR MD 3000	SET1045					6 M75, - 05/91
	SINPAR MD 3000	SET1088					6 M70, - 05/91
	SINPAR MD 3000	SET1044					6 M70, - 05/91
	SINPAR MD 4000	SET1048					-05/91
	SINPAR MD 4000	SET1048					-05/91
	3 MRDIF 155/156/158/171/214	SET1047					-05/91
	3 MRDIF 155/156/158/171/214	SET1045					-05/91
	3 MRDIF 216/219	SET1047					-05/91
	3 MRDIF 216/219	SET1045					-05/91
	3 MRDIF 8274	SET1047					-05/91
	3 MRDIF 8274	SET1047					-05/91
	3 MRDIS 8500 FW	SET1047					-05/91
	3 MRDIS 8500 FW	SET1047					-05/91
	P 620 D1			SET1088			-05/91
	P 620 F			SET1090			-05/91
	P 620 F			SET1089			-05/91
	P 821/P 1021			594/593X			
	P 821/P 1021			594/593X			
	P 1021 K			594/593X			-05/91
	P 1021 K			SET1066			-05/91
<b>110.170 [4X4]</b>							
	E 408-5	SET1111					
	E 408-5	SET1108					
	SINPAR MD 3000	SET1089					6 M75, - 05/91
	SINPAR MD 3000	SET1045					6 M75, - 05/91
	SINPAR MD 3000	SET1088					6 M70, - 05/91
	SINPAR MD 3000	SET1044					6 M70, - 05/91
	SINPAR MD 4000	SET1048					-05/91
	SINPAR MD 4000	SET1048					-05/91
	3 MRDIF 155/156/158/171/214/216/219	SET1047					-05/91
	3 MRDIF 155/156/158/171/214/216/219	SET1045					-05/91
	3 MRDIF 8274	SET1047					-05/91
	3 MRDIF 8274	SET1047					-05/91
	3 MRDIS 8500 FW	SET1047					-05/91
	3 MRDIS 8500 FW	SET1047					-05/91
	P 620 D1			SET1088			-05/91
	P 620 F			SET1090			-05/91
	P 620 F			SET1089			-05/91
	P 821/P 1021			594/593X			
	P 821/P 1021			594/593X			
	P 1021 K			594/593X			-05/91
	P 1021 K			SET1066			-05/91



# APPLICATION LISTINGS - TRUCK

A













					
<b>RENAULT RVI</b>					
<b>130 B6/B6A/B9/B9A</b>					
	401 401 SOMA 95 SOMA 95	32210 32207	SET1089 33013		
<b>130 B11/B13/B14, 150 B11/B13</b>					
	15 M/15 MHD/17 M 15 M/15 MHD/17 M 467-26 467-26 P 620 F/F1 P 620 F/F1 P 821 F/F1 P 821 F/F1	SET1060 32208	SET1090 SET1089 SET1090 SET1089 SET1090 SET1089 594/593X 594/593X		-12/92 -12/92 -12/92 -12/92
<b>770 KB 6</b>					
	E3A-10 E3A-10 E3A-11 E3A-11 P 620 D1 P 621 B1	SET1112 SET1097 SET1112 SET1097	SET1088 594/593X		
<b>AE 380/385 T I/390 MAGNUM</b>					
	E 81 E 81 1341 1341 1345 840 A 840 A	EK50042 EK50042	SET1166 SET1116 SET1166 SET1049 SET1103		-01/93 -01/93
<b>AE 420 T I/430 MAGNUM</b>					
	E 81 E 81 1341 1341 1345 840 A 840 A	EK50042 EK50042	SET1166 SET1116 SET1166 SET1049 SET1103		-01/93 -01/93
<b>AE 470 MAGNUM</b>					
	E 81 E 81 1345	EK50042 EK50042	SET1166		-01/93 -01/93
<b>AE 500/520/560 MAGNUM</b>					
	E 81 E 81 1341 1341 1345	EK50042 EK50042	SET1166 SET1116 SET1166		-01/93 -01/93

















				 			
<b>RENAULT RVI</b>							
<b>AE 500/520/560 MAGNUM ...</b>							
	840 A 840 A			SET1049 SET1103		I O	
<b>B 70</b>							
	369 369 369 369 569-39 569-39	SET1096 33205 32008X 30205		SET1041 SET1040		I O I O I O	18/11/85 - 18/11/85 - -15/11/85 -15/11/85
<b>B 80</b>							
	569-01-39 569-01-39	SET1096 33205 SET1096 32305		SET1041 SET1040		I O I O I O	-17/11/93 -17/11/93 18/11/93 - 18/11/93 - -08/93 -08/93
<b>B 90</b>							
	369 369 569-39 569-39 669-02 669-02	32008X 30205		SET1041 SET1040 SET1088 SET1087		I O I O I O	
<b>B 110 [4X2]</b>							
	569-01-39 569-01-39	SET1096 33205 SET1096 32305		SET1041 SET1040		I O I O I O	-17/11/93 -17/11/93 18/11/93 - 18/11/93 - -08/93 -08/93
<b>B 110 [4X4]</b>							
	569-10 569-10 669-04 669-04 669-04 669-04	SET1043 SET1041 SET1042 SET1040		33013 SET1041 SET1088 SET1087		I O I O I O I O	-08/93 -08/93 09/93 - 09/93 - -08/93 -08/93 09/93 - 09/93 -
<b>B 120</b>							
	569-01-39 569-01-39	SET1096 33205 SET1096 32305		SET1041 SET1040		I O I O I O	-17/11/93 -17/11/93 18/11/93 - 18/11/93 - -08/93 -08/93



# APPLICATION LISTINGS - TRUCK

A



















					
<b>RENAULT RVI</b>					
<b>CE 160 MAROC</b>					
	E 400-04/14 E 408-05/13/15/24	SET1111 SET1108			
<b>C 210</b>					
	E6A-4C E6A-4C E6A-4C P 1332 P 1332	SET1114 SET1109 SET1114	SET1169 64432/64708		-14/03/84 -14/03/84 15/03/84 -
<b>C 230/C 260/C 280/C 290 [4X2] [4X4]</b>					
	E6A-4C E6A-711 PA-721 B PA-721 B P 1332 P 1332	SET1114 SET1114 594/593X 594/593X	SET1169 64432/64708		15/03/84 - 15/03/84 -
<b>C 260/C 280/C 290 [6X4]</b>					
	E5A-4E E5A-4E E5A-4E E5A-4E E6A-4C E6A-4C E6A-4C E6A-711 PMA/PR 1141-A PMA/PR 1321 PMA/PR 1321 PMA/PR 1341 PMA/PR 1341	SET1113 SET1110 SET1113 SET1110 SET1114 SET1109 SET1114 SET1114	SET1049 SET109 52375/52618 SET1166 SET1116		- 03/93 - 03/93 04/93 - 04/93 - -14/03/84 -14/03/84 15/03/84 - 15/03/84 -
<b>C 300/C 340 TI [4X2] [4X4]</b>					
	E6A-4C E6A-4C E6A-4C E6A-711 PA-721 B PA-721 B P 1332 P 1332	SET1114 SET1109 SET1114 SET1114 594/593X 594/593X	SET1169 64432/64708		-14/03/84 -14/03/84 15/03/84 - 15/03/84 -
<b>C 300/C 340 TI [6X4]</b>					
	E5A-4E E5A-4E E5A-4E E5A-4E E6A-4C E6A-4C E6A-4C E6A-711 PMA/PR 1141-A PMA/PR 1321	SET1113 SET1109 SET1113 SET1110 SET1114 SET1109 SET1114 SET1114	SET1049 SET109		-03/93 -03/93 04/93 - 04/93 - -14/03/84 -14/03/84 15/03/84 - 15/03/84 -























					
<b>RENAULT RVI</b>					
<b>C 300/C 340 TI [6X4] ...</b>					
	PMA/PR 1321 PMA/PR 1341 PMA/PR 1341		52375/52618 SET1166 SET1116		
<b>CBH 280/340/350/380 [6X4]</b>					
	E6A P/PMA 1532 P/PMA 1532	SET1114	SET1169 64432/64708		
<b>CBH 280/340/350 [6X6]</b>					
	PA-721 PA-721 P/PMA 1532 P/PMA 1532	594/593X SET1066	SET1169 64432/64708		
<b>CBH 320/385 [6X4]</b>					
	E6B-811 P/ PMA 1532-01 P/ PMA 1532-01	SET1114	SET1169 64432/64708		
<b>CBH 320/385 [6X6]</b>					
	PA-721-02 PA-721-02 P/ PMA 1532-01 P/ PMA 1532-01	594/593X SET1066	SET1169 64432/64708		
<b>CLM 280/340/350/380</b>					
	E6A-511 P 1532-11/12 P 1532-11/12	SET1114	SET1169 64432/64708		
<b>CLM 320/385 [4X2]</b>					
	E6A-511/811 P 1532-01/11 P 1532-01/11	SET1114	SET1169 64432/64708		
<b>CLR 220 [4X2]</b>					
	E6A-711 P 1332 P 1332	SET1114	SET1169 64432/64708		
<b>CLR 220 [4X4]</b>					
	PA-721 B PA-721 B P 1332 P 1332	594/593X SET1066	SET1169 64432/64708		
<b>CLR 230</b>					
	E5A E5A E5A E5A E6A P 1332	SET1113 SET1109 SET1113 SET1110 SET1114	SET1169		-03/93 -03/93 04/93 - 04/93 -



# APPLICATION LISTINGS - TRUCK

















A

													
<b>RENAULT RVI</b>													
<b>CLR 230 ...</b>													
	P 1332 PMA/PR 1141-A PMA/PR 1341 PMA/PR 1341						64432/64708 SET1049 SET1166 SET1116						
<b>G 170-11/13/15</b>													
	E4A E4A E5A-921 E5A-921 E5A E5A P 1141 P 1141	SET1112 SET1097 SET1113 SET1109 SET1113 SET1109					SET1166 SET1116					-09/84 -09/84 -01/86 -01/86 02/86 - 02/86 -	
<b>G 170-16/17</b>													
	E5A E5A E5A E5A P 1141 P 1141	SET1113 SET1109 SET1113 SET1109					SET1166 SET1116					-01/86 -01/86 02/86 - 02/86 -	
<b>G 200</b>													
	E5 E5 E5 E5 E5 E5 E6 E6 E6 P 1140 P 1140 P 1141/P 1341 P 1141/P 1341 P 1332 P 1332 P 1345	SET1113 SET1109 SET1113 SET1109 SET1113 SET1109 SET1114 SET1114 SET1114					SET1166 SET1103 SET1166 SET1116 SET1169 64432/64708 SET1166					-08/91  -08/91  -08/91  -08/91  09/91-03/93 09/91-03/93 -08/91  -08/91  09/91-	
<b>G 210</b>													
	E5A-4C E5A-4C E5A-4C E5A-4C E5A -23 E5A -23 E5A-821 E5A-821 E5A-821 E5A-821 E5A-921 E5A-921	SET1113 SET1109 SET1113 SET1109 SET1113 SET1109 SET1113 SET1109 SET1113 SET1109 SET1113 SET1109										-01/86 -01/86 02/86- 02/86- -02/86 -02/86 03/86- 03/86- -12/87 -12/87	













				 			
<b>RENAULT RVI</b>							
<b>G 210 ...</b>							
	E6A-4D E6A-4D E6A-4D P 1141/P 1341 P 1141/P 1341 P 1332 P 1332	SET1114 SET1109 SET1114		SET1166 SET1116 SET1169 64432/64708		-14/03/84 -14/03/84 15/03/84-	
<b>G 210 MANAGER</b>							
	E5 E5 E5 E5 E5 E5 E6 E6 E6 P 1140 P 1140 P 1141/P 1341 P 1141/P 1341 P 1332 P 1332 P 1345	SET1113 SET1109 SET1113 SET1109 SET1113 SET1109 SET1114 SET1114 SET1114		SET1166 SET1103 SET1166 SET1116 SET1169 64432/64708 SET1166		-08/91  -08/91  -08/91  -08/91  09/91-03/93 09/91-03/93 -08/91  -08/91  09/91 -	
<b>G 220 BOM</b>							
	E5A-23 E5A-23 E5A-23 E5A-23 E5A-23 E5A-23 E5B-4C E5B-4C E5B-4C E5B-4C E5B-4C E5B-4C E5B-4C E5B-4C E5B-4C E6B-4D E6B-4D E6B-4D P 1341 C P 1341 C P 1332 P 1332 P 1345	SET1113 SET1109 SET1113 SET1109 SET1113 SET1110 SET1113 SET1109 SET1113 SET1109 SET1113 SET1109 SET1113 SET1110 SET1114 SET1114 SET1114		SET1166 SET1116 SET1169 64432/64708 SET1166		-08/91 -08/91 09/91-03/93 09/91-03/93 04/93 - 04/93 - -08/91  -08/91  -08/91  -08/91  09/91-03/93 09/91-03/93 04/93 - 04/93 - -08/91  -08/91  09/91 -	
<b>G 230</b>							
	E5A-4C E5A-4C E5A-4C	SET1113 SET1109 SET1113				-01/86 -01/86 02/86 -	



A





















				 				
<b>RENAULT RVI</b>								
<b>G 230 ...</b>								
	E5A-4C E5A -23 E5A -23 E5A-821 E5A-821 E5A-821 E5A-821 E5A-921 E5A-921 E5A-921 E6A-4D E6A-4D E6A-4D P 1141/P 1341 P 1141/P 1341 P 1332 P 1332	SET1109 SET1113 SET1109 SET1113 SET1109 SET1113 SET1109 SET1113 SET1109 SET1114 SET1109 SET1114		SET1166 SET1116 SET1169 64432/64708		02/86 -  -02/86 -02/86 03/86 - 03/86 - -12/87 -12/87 -14/03/84 -14/03/84 15/03/84 -		
<b>G 230 INCENDIE</b>								
	E5A-4C E5A-4C E5A-4C E5A-4C E5A-921 E5A-921 P 1141 P 1141	SET1113 SET1109 SET1113 SET1110 SET1113 SET1109		SET1166 SET1116		-03/93 -03/93 04/93 - 04/93 -		
<b>G 230 TI</b>								
	E5 E5 E5 E5 E5 E5 E6 E6 E6 P 1140 P 1140 P 1141/P 1341 P 1141/P 1341 P 1332 P 1332 P 1345	SET1113 SET1109 SET1113 SET1109 SET1113 SET1109 SET1114 SET1114 SET1114		SET1166 SET1103 SET1166 SET1116 SET1169 64432/64708 SET1166		-08/91  -08/91  - 08/91  - 08/91  09/91-03/93 09/91-03/93 -08/91  - 08/91  09/91 -		
<b>G 235 MAXTER [4X2]</b>								
	P 1541 A P 1541 A P 1545 A	EK50042 EK50042		SET1166 SET1116 SET1166				



























				 			
<b>RENAULT RVI</b>							
<b>G 260 [11/13]</b>							
	E4A E4A E5A E5A P 1141 P 1141	SET1112 SET1097 SET1113 SET1109		SET1166 SET1116		-09/84 -09/84 10/84 - 10/84 -	
<b>G 260 [15 T]</b>							
	E4A E4A E5A E5A P 1141 P 1141	SET1112 SET1097 SET1113 SET1109		SET1166 SET1116		-09/83 -09/83 10/83 - 10/83 -	
<b>G 260 [16/17 T]</b>							
	E5A E5A E5A-4C E5A-4C P 1141 P 1141	SET1113 SET1109 SET1113 SET1109		SET1166 SET1116		-01/86 -01/86 02/86 - 02/86 -	
<b>G 260 [19 T]</b>							
	E5A E5A E5A-821 E5A-821 E6A E6A E6A P 1141/P 1341 P 1141/P 1341 P 1332 P 1332	SET1113 SET1109 SET1113 SET1109 SET1114 SET1109 SET1114		SET1166 SET1116 SET1169 64432/64708		03/86 - 03/86 - -14/03/84 -14/03/84 15/03/84 -	
<b>G 260 [22 T]</b>							
	E5A E5A P 1141 P 1141	SET1113 SET1109		SET1166 SET1116		-09/84 -09/84	
<b>G 260 [26 T]</b>							
	E5A E5A E6A E6A E6A P/PR 1341 P/PR 1341	SET1113 SET1109 SET1114 SET1109 SET1114		SET1166 SET1116		-14/03/84 -14/03/84 15/03/84 -	



A













													
<b>RENAULT RVI</b>													
<b>G 270 BOM</b>													
	E5A-23	SET1113											-08/91
	E5A-23	SET1109											-08/91
	E5A-23	SET1113											09/91-03/93
	E5A-23	SET1109											09/91-03/93
	E5A-23	SET1113											04/93 -
	E5A-23	SET1110											04/93 -
	E5B-4C	SET1113											-08/91 
	E5B-4C	SET1109											-08/91 
	E5B-4C	SET1113											-08/91 
	E5B-4C	SET1109											-08/91 
	E5B-4C	SET1113											09/91-03/93
	E5B-4C	SET1109											09/91-03/93
	E5B-4C	SET1113											04/93 -
	E5B-4C	SET1110											04/93 -
	E6B-4D	SET1114											-08/91 
	E6B-4D	SET1114											-08/91 
	E6B-4D	SET1114											09/91 -
	P 1341 C						SET1166						
	P 1341 C						SET1116						
	P 1332						SET1169						
	P 1332						64432/64708						
	P 1345						SET1166						
<b>G 270 INCENDIE</b>													
	E5A-4C	SET1113											-03/93
	E5A-4C	SET1109											-03/93
	E5A-4C	SET1113											
	E5A-4C	SET1110											
	E5A-921	SET1113											
	E5A-921	SET1109											
	P 1141						SET1166						
	P 1141						SET1116						
<b>G 270/280 MANAGER [4X2] [6X2/4]</b>													
	E5A-23	SET1113											-08/91
	E5A-23	SET1109											-08/91
	E5A-23	SET1113											09/91-03/93
	E5A-23	SET1109											09/91-03/93
	E5A-23	SET1113											04/93 -
	E5A-23	SET1110											04/93 -
	E5A-4C/E5B-4C	SET1113											-08/91 
	E5A-4C/E5B-4C	SET1109											-08/91 
	E5A-821	SET1113											-08/91 
	E5A-821	SET1109											-08/91 
	E5A-4C/E5B-4C	SET1113											-08/91 
	E5A-4C/E5B-4C	SET1109											-08/91 
	E5A-821	SET1113											-08/91 
	E5A-821	SET1109											-08/91 
	E5A-4C/E5B-4C	SET1113											09/91-03/93
	E5A-4C/E5B-4C	SET1109											09/91-03/93
	E5A-821	SET1113											09/91-03/93
	E5A-821	SET1109											09/91-03/93
	E5A-4C/E5B-4C	SET1113											04/93 -
	E5A-4C/E5B-4C	SET1110											04/93 -





























				 			
<b>RENAULT RVI</b>							
<b>G 270/280 MANAGER [4X2] [6X2/4] ...</b>							
	E5A-821 E5A-821 E6A-4D E6B-4D E6A/E6 B E6A/E6 B E6A/E6 B P 1141/ P 1341 P 1141/ P 1341 P 1332 P 1332 P 1142/ P 1345	SET1113 SET1110 SET1114 SET1114 SET1114 SET1114 SET1114 SET1114		SET1166 SET1116 SET1169 64432/64708 SET1166		04/93 - 04/93 -  -08/91  -08/91  09/91 - -08/91 -08/91	
<b>G 270/280 MANAGER [4X4]</b>							
	PA 721 B PA 721 B P 1141/ P 1341 P 1141/ P 1341 P 1332 P 1332 P 1142/ P 1345	594/593X SET1066		SET1166 SET1116 SET1169 64432/64708 SET1166		-08/91 -08/91	
<b>G 270/280 MANAGER [6X2] [6X4] [8X4]</b>							
	E5A-821 E5A-821 E5A-821 E5A-821 E5A-821 E5A-821 E5A-821 E5A-821 E5A-821 E5A-821 E5A-821 E5A-821 E6A-4D/E6B-4D E6A/E6B E6A/E6B E6A/E6B PR/PMA 1141 A P 1332 P 1332 PMA 1341 PMA 1341 P 1345	SET1113 SET1109 SET1113 SET1109 SET1113 SET1109 SET1113 SET1109 SET1113 SET1109 SET1113 SET1109 SET1114 SET1114 SET1114 SET1114		SET1049 SET1169 64432/64708 SET1166 SET1116 SET1166		-08/91  -08/91  -08/91  -08/91  09/91 - 03/93  09/91 - 03/93  -03/93  -03/93  -03/93  -03/93  04/93 - 04/93 -  -08/91  -08/91  09/91 -	
<b>G 290 16/17 T</b>							
	E5A E5A E5A-4C E5A-4C P 1141 P 1141	SET1113 SET1109 SET1113 SET1109		SET1166 SET1116		-01/86 -01/86 02/86 - 02/86 -	



# APPLICATION LISTINGS - TRUCK

A















						
<b>RENAULT RVI</b>						
<b>G 290 [VTL] [6x4]</b>						
	E6A E6A P 1141 P 1141	SET1114 SET1114		SET1166 SET1116		ABS
<b>G 290 19 T</b>						
	E5A-23 E5A-23 E6A E6A E6A P 1332 P 1332 P/PR 1341 P/PR 1341	SET1113 SET1109 SET1114 SET1109 SET1114		SET1169 64432/64708 SET1166 SET1116		-01/86 -01/86 -14/03/84 -14/03/84 15/03/84 -
<b>G 290 [VTL]</b>						
	E6A-4D PR/PMA 1341 PR/PMA 1341	SET1114		SET1166 SET1116		
<b>G 300 MAXTER [4X2]</b>						
	P 1541 A P 1541 A P 1545 A	EK50042 EK50042		SET1166 SET1116 SET1166		
<b>G 300 MAXTER [6X4] [8X4]</b>						
	ESS 83 ESS 83 PR/PMA 1141 A PR/PMA 1841 B PR/PMA 1841 B PR/PMA 1845 B	EK50042 EK50042		SET1049 SET1166 SET1116 SET1166		09/93 - 09/93 -
<b>G 300/330/340 TI MANAGER [4X2] [6X2] [6X4]</b>						
	E5A-23 E5A-23 E5A-23 E5A-23 E5A-23 E5A-23 E5A-4C/E5B-4C E5A-4C/E5B-4C E5A-821 E5A-821 E5A-4C/E5B-4C E5A-4C/E5B-4C E5A-821 E5A-821 E5A-4C/E5B-4C E5A-4C/E5B-4C E5A-821 E5A-821 E5A-4C/E5B-4C E5A-4C/E5B-4C E5A-821	SET1113 SET1109 SET1113 SET1109 SET1113 SET1110 SET1113 SET1109 SET1113 SET1109 SET1113 SET1109 SET1113 SET1109 SET1113 SET1109 SET1113 SET1109 SET1113 SET1109 SET1113				-08/91 -08/91 09/91-03/93 09/91-03/93 04/93 - 04/93 - -08/91 ABS -08/91 ABS -08/91 ABS -08/91 ABS -08/91 ABS -08/91 ABS -08/91 ABS -08/91 ABS 09/91-03/93 09/91-03/93 09/91-03/93







					
<b>RENAULT RVI</b>					
<b>G 300/330/340 TI MANAGER [4X2] [6X2] [6X4] ...</b>					
	E5A-821 E5A-4C/E5B-4C E5A-4C/E5B-4C E5A-821 E5A-821 E6A-4D/E6B-4D E6A/E6B E6A/E6B E6A/E6B P 1141/P 1341 P 1141/P 1341 P 1332 P 1332 P 1142 P 1345	SET1109 SET1113 SET1110 SET1113 SET1110 SET1114 SET1114 SET1114 SET1114 SET1114	SET1166 SET1116 SET1169 64432/64708 SET1166 SET1166		09/91-03/93 04/93 - 04/93 - 04/93 - 04/93 - 04/93 - -08/91  -08/91  09/91 - -08/91
<b>G 300/330/340 TI MANAGER [4X4]</b>					
	PA 721 B PA 721 B P 1141/ P 1341 P 1141/ P 1341 P 1332 P 1332 P 1142/ P 1345	594/593X SET1066	SET1166 SET1116 SET1169 64432/64708 SET1166		
<b>G 300/330/340 TI MANAGER [6X2] [6X4] [8X4]</b>					
	E5A-821 E5A-821 E5A-821 E5A-821 E5A-821 E5A-821 E5A-821 E5A-821 E5A-821 E5A-821 E5A-821 E6A-4D E6B-4D E6A/E6B E6A/E6B E6A/E6B PR/PMA 1141 A P 1332 P 1332 PMA 1341 PMA 1341 P 1345	SET1113 SET1109 SET1113 SET1109 SET1113 SET1109 SET1113 SET1109 SET1113 SET1109 SET1113 SET1109 SET1114 SET1114 SET1114 SET1114 SET1114	SET1049 SET1169 64432/64708 SET1166 SET1116 SET1166		-08/91   -08/91   -08/91   -08/91   09/91 - 03/93  09/91 - 03/93  -03/93  20° -03/93  20° -03/93  24° -03/93  24° 04/93 - 04/93 - -08/91  -08/91  09/91 -
<b>G 320-19 [VF6-BA]</b>					
	E6A-4D P 1332 P 1332	SET1114	SET1169 64432/64708		



# APPLICATION LISTINGS - TRUCK

A













					
<b>RENAULT RVI</b>					
<b>G 320-19 T [VF6-BG]</b>					
	E5A-821 E5A-821 P 1332 P 1332	SET1113 SET1109	SET1169 64432/64708		
<b>G 340 TI MAXTER [4X2]</b>					
	P 1541 A P 1541 A P 1545 A	EK50042 EK50042	SET1166 SET1116 SET1166		
<b>G 340 TI MAXTER [6X4] [8X4]</b>					
	ESS 83 ESS 83 PR/PMA 1141 A PR/PMA 1841 B PR/PMA 1841 B PR/PMA 1845 B	EK50042 EK50042	SET1049 SET1166 SET1116 SET1166		09/93 - 09/93 -
<b>G 340 TI MAXTER [6X6]</b>					
		SET1166	SET1166		
<b>GB 131-HR 15</b>					
	E4A E4A P 920-B1/F/G/H P 920-B1/F/G/H P 921-B1/F/G/H P 921-B1/F/G/H	SET1112 SET1097	594/593X 665X/653X 594/593X 594/593X		
<b>GB 191/231</b>					
	E4A E4A P 921-B1/F/G/H P 921-B1/F/G/H	SET1112 SET1097	594/593X 594/593X		
<b>GBC 180</b>					
	REAR REAR FORWARD REAR		SET1066 SET1066		
<b>GBH 260 [4X4]</b>					
	E6A E6A PR/PMA 1032 PR/PMA 1032	SET1114 SET1109	SET1169 64432/64708		
<b>GBH 260 [6X6]</b>					
	PKBS 3 PKBS 3 PR/PMA 1032 PR/PMA 1032	SET1048 SET1047	SET1169 64432/64708		

				 			
<b>RENAULT RVI</b>							
<b>GBH 280 [6X4]</b>							
	E6A E6A E6A PR/PMA 1532 PR/PMA 1532	SET1114 SET1109 SET1114		SET1169 64432/64708		I O I I O	-14/03/84 -14/03/84 15/03/84 -
<b>GBH 280 D [6X4]</b>							
	E6 A E6 A E6A-511 PR/PMA 1532 PR/PMA 1532	SET1114 SET1109 SET1114		SET1169 64432/64708		I O I I O	-14/03/84 -14/03/84 15/03/84 -
<b>GBH 280 [6X6]</b>							
	PKBS 3 PKBS 3 PR/PMA 1032 PR/PMA 1032	SET1048 SET1047		SET1169 64432/64708		I O I I O	
<b>GBH 280 E [6X6]</b>							
	PA 721 PA 721 PR/PMA 1532 PR/PMA 1532	594/593X SET1066		SET1169 64432/64708		I O I I O	
<b>GC 191/231, GF 191/231</b>							
	E5A E5A P 1021 P 1021	SET1113 SET1109		SET109 52375/52618		I O I I O	
<b>GLC 190</b>							
	E5A E5A P 1021 P 1021 P 1321 P 1321	SET1113 SET1109		SET109 52375/52618 SET109 52375/52618		I O I O I O	-08/79 -08/79 09/79 - 09/79 -
<b>GLM 280</b>							
	E6A-51 E6A-51 E6A-51 P 1532 P 1532	SET1114 SET1109 SET1114		SET1169 64432/64708		I O I I O	-14/03/84 -14/03/84 15/03/84 -
<b>GLR 190/230</b>							
	E6A E6A E6A P 1332 P 1332	SET1114 SET1109 SET1114		SET1169 64432/64708		I O I I O	-14/03/84 -14/03/84 15/03/84 -









# APPLICATION LISTINGS - TRUCK

A

					
<b>RENAULT RVI</b>					
<b>GLR 230 [4X4]</b>					
	PA 721 PA 721 PR/PMA 1532 PR/PMA 1532	594/593X SET1066	SET1169 64432/64708		
<b>GR 191/231</b>					
	E6A E6A E6A P 1321 P 1321 P 1332 P 1332	SET1114 SET1109 SET1114	SET109 52375/52618 SET1169 64432/64708		-14/03/84 -14/03/84 15/03/84 -
<b>GR 280/305/350</b>					
	E6A 2/ E6A 31 E6A 2/ E6A 31 P 1332/P 1332 B P 1332/P 1332 B	SET1114 SET1109	SET1169 64432/64708		
<b>GRH 235</b>					
	E6A E6A P/PMA 1021 P/PMA 1021	SET1114 SET1109	SET109 52375/52618		
<b>GRH 235 R</b>					
	E6A E6A P/PMA 1321 P/PMA 1321	SET1114 SET1109	SET109 52375/52618		
<b>GRH 305 [6X4]</b>					
	E6A-21 E6A-21 PMA 1021/PMA 1321 PMA 1021/PMA 1321 P 1032 B/ PMA 1532 P 1032 B/ PMA 1532	SET1114 SET1109	SET109 52375/52618 SET1169 64432/64708		
<b>GRH 350 [6X4], GRH 350 TS</b>					
	E6A E6A PMA/PR/P 1021 PMA/PR/P 1021 PMA/PR 1321 PMA/PR 1321 PMA/PR 1032 B PMA/PR 1032 B PMA/P 1532 PMA/P 1532	SET1114 SET1109	SET109 52375/52618 SET109 52375/52618 SET1169 64432/64708 SET1169 64432/64708		

















				 			
<b>RENAULT RVI</b>							
<b>JK 50/55/60/65/75</b>							
	402	SET1109		I		-14/06/85	
	402	32206		O		-14/06/85	
	402	SET1109		I		17/06/85 -	
	402	SET1106		O		17/06/85 -	
	669		SET1088	I			
	669		SET1087	O			
	70 HD		SET1088	I			
	70 HD		SET1087	O			
<b>JN 60/75/85/90/95</b>							
	E 401	32210		I			
	E 401	32207		O			
	SOMA 95		SET1089	I			
	SOMA 95		33013	O			
<b>JP 11</b>							
	400	SET1060		I			
	400	32208		O			
	P 620 F		SET1090	I		-12/82	
	P 620 F		SET1089	O		-12/82	
	P 620 F1		SET1090	I		01/83 -	
	P 620 F1		SET1089	O		01/83 -	
	15 M		SET1090	I			
	15 M		SET1089	O			
<b>JP 13/A/B/C, JP 14 BOM</b>							
	400	SET1060		I			
	400	32208		O			
	P 820 F		SET1090	I		-12/82	
	P 820 F		SET1089	O		-12/82	
	P 820 F1		SET1090	I		01/83 -	
	P 820 F1		SET1089	O		01/83 -	
	15 M/MHD, 17 M		SET1090	I			
	15 M/MHD, 17 M		SET1089	O			
<b>JR 19/21, JX 21</b>							
	400	SET1060		I			
	400	32208		O			
	P 17 M		SET1090	I			
	P 17 M		SET1089	O			
	P 821 F		594/593X	I		-12/82	
	P 821 F		594/593X	O		-12/82	
	P 821 F1		594/593X	I		01/83 -	
	P 821 F1		594/593X	O		01/83 -	
<b>KERAX</b>							
	1141 A	EK50042		I			
	1541 A	EK50042		O			
	1541 A		SET1049	I			
	1545 A		SET1166	O			
	1841 B		SET1116	I			
	1841 B		SET1166	O			
	1841 B		SET1166	I			
	1841 B		SET1116	O			



# APPLICATION LISTINGS - TRUCK







A







































































































													
<b>RENAULT RVI</b>													
<b>KERAX ...</b>													
	1845 B				SET1166					I			
	PA 945				SET1191					O			
<b>M 140/160</b>													
	E 400		SET1111							I			-07/90
	E 400		SET1108							O			-07/90
	E 400		SET1111							I			08/90 -
	E 400		SET1108							O			08/90 -
	E5A-221		SET1113							I			-08/91
	E5A-221		SET1109							O			-08/91
	E5A-221		SET1113							I			09/91-03/93
	E5A-221		SET1109							O			09/91-03/93
	E5A-221		SET1113							I			04/93 -
	E5A-221		SET1110							O			04/93 -
	P 1140 D				SET1049					I			
	P 1141 D				SET1049					O			
	P 1340-A02				SET1166					I			
	P 1340-A02				SET1103					O			
	P 1341-A02				SET1166					I			
	P 1341-A02				SET1116					O			
	P 769-02				SET1049					I			-02/91
	P 769-02				SET1047					O			-02/91
	P 769-02				SET1049					I			03/91 -
	P 769-02				SET1047					O			03/91 -
	P 941-A01				SET1049					I			-02/91
	P 941-A01				SET1049					O			03/91 -
<b>M 150/180</b>													
	E 408-05		SET1111							I			
	E 408-05		SET1108							O			
	P 821/P 1021				594/593X					I			
	P 821/P 1021				594/593X					O			
<b>M 150/180 [VF6-40 ACA/ACC]</b>													
	E 400		SET1111							I			
	E 400		SET1108							O			
	E 401		SET1110							I			
	E 401		SET1107							O			
	E 402		SET1109							I			
	E 402		SET1107							O			
	E5A		SET1113							I			-03/93
	E5A		SET1109							O			-03/93
	E5A		SET1113							I			04/93 -
	E5A		SET1110							O			04/93 -
	1140				SET1049					I			
	1140				SET1103					O			
	1141				SET1049					I			
	1340				SET1166					O			
	1340				SET1103					I			
	1341				SET1166					O			
	1341				SET1116					I			
	669				SET1088					O			-05/95
	669				SET1087					I			-05/95
	669				SET1045					O			06/95 -

													
<b>RENAULT RVI</b>													
<b>M 150/180 [VF6-40 ACA/ACC] ...</b>													
	669				SET1043								06/95 -
	769-02				SET1049								
	769-02				SET1047								
	769-05				SET1089								
	769-05				33013								
	769-06				SET1045								
	769-06				SET1043								
	940				SET1049								
	940				SET1047								
	941				SET1049								
<b>M 180 [VF6-40 ACB/ACD]</b>													
	E 400		SET1111										
	E 400		SET1108										
	E 401		SET1110										
	E 401		SET1107										
	E 402		SET1109										
	E 402		SET1107										
	E5A		SET1113										-03/93
	E5A		SET1109										-03/93
	E5A		SET1113										04/93 -
	E5A		SET1110										04/93 -
	1140				SET1049								
	1140				SET1103								
	1141				SET1049								
	1340				SET1166								
	1340				SET1103								
	1341				SET1166								
	1341				SET1116								
	669				SET1088								-05/95
	669				SET1087								-05/95
	669				SET1045								06/95 -
	669				SET1043								06/95 -
	769-02				SET1049								
	769-02				SET1047								
	769-05				SET1089								
	769-05				33013								
	769-06				SET1045								
	769-06				SET1043								
	940				SET1049								
	940				SET1047								
	941				SET1049								
<b>M 180/210</b>													
	E 408-05		SET1111										
	E 408-05		SET1108										
	P 821				594/593X								
	P 821				594/593X								
	P 1021				594/593X								
	P 1021				594/593X								











									
									
<b>RENAULT RVI</b>									
<b>M 200/230</b>									
E 400	SET1111			I	-07/90				
E 400	SET1108			O	-07/90				
E 400	SET1111			O	08/90 -				
E 400	SET1108			O	08/90 -				
E5A-221	SET1113			O	-08/91				
E5A-221	SET1109			O	-08/91				
E5A-221	SET1113			O	09/91-03/93				
E5A-221	SET1109			O	09/91-03/93				
E5A-221	SET1113			O	04/93 -				
E5A-221	SET1110			O	04/93 -				
P 1140 D		SET1049		O					
P 1141 D		SET1049		O					
P 1340-A02		SET1166		O					
P 1340-A02		SET1103		O					
P 1341-A02		SET1166		O					
P 1341-A02		SET1116		O					
P 769-02		SET1049		O	-02/91				
P 769-02		SET1047		O	-02/91				
P 769-02		SET1049		O	03/91 -				
P 769-02		SET1047		O	03/91 -				
P 941-A01		SET1049		O	-02/91				
P 941-A01		SET1049		I	03/91 -				
<b>M 210/230 TI [VF6-40]</b>									
E 400	SET1111			I					
E 400	SET1108			O					
E 401	SET1110			O					
E 401	SET1107			O					
E 402	SET1109			O					
E 402	SET1107			O					
E5A	SET1113			O	-03/93				
E5A	SET1109			O	-03/93				
E5A	SET1113			O	04/93 -				
E5A	SET1110			O	04/93 -				
1140		SET1049		O					
1140		SET1103		O					
1141		SET1049		O					
1340		SET1166		O					
1340		SET1103		O					
1341		SET1166		O					
1341		SET1116		O					
669		SET1088		O	-05/95				
669		SET1087		O	-05/95				
669		SET1045		O	06/95 -				
669		SET1043		O	06/95 -				
769-02		SET1049		O					
769-02		SET1047		O					
769-05		SET1089		O					
769-05		33013		O					
769-06		SET1045		O					
769-06		SET1043		O					
940		SET1049		O					
940		SET1047		O					
941		SET1049		I					







				 			
<b>RENAULT RVI</b>							
<b>M 250</b>							
	E5A E5A E5A E5A 1140 1140 1140 1141 1340 1340 1341 1341 669-03 669-03 669-03/05 669-03/05 769-02 769-02 769-05 769-05 769-06 769-06 940 940 941	SET1113 SET1109 SET1113 SET1110	SET1049 SET1049 SET1103 SET1049 SET1166 SET1103 SET1166 SET1116 SET1088 SET1087 SET1045 SET1043 SET1049 SET1047 SET1089 33013 SET1045 SET1043 SET1049 SET1047 SET1049	                                                 	-03/93 -03/93 04/93 - 04/93 - ABS ABS ABS -05/95 -05/95 06/95 - 06/95 -		
<b>MAGNUM 390/430/470/560</b>							
	E 81 1341 1341 11 E/F 11 E/F 840 A 840 A 1345 1370 1370	EK50042	SET1166 SET1116 SET414 SET1113 SET1049 SET1103 SET1166 SET1166 SET1103	                         	-01/93		
<b>MAGNUM 400/440/480 E-TECH</b>							
	840 A 840 A 1345 1370 1370 1341 1341		SET1049 SET1103 SET1166 SET1166 SET1103 SET1166 SET1116	             			
<b>ME 160 [VF6-JE13] [4X2]</b>							
	E 400-04/14 E 400-04/14 E 408-AA E 408-AA E 408-05/13/15/24 E 408-05/13/15/24	SET1111 SET1108 SET1114 SET1110 SET1111 SET1108		     			



# APPLICATION LISTINGS - TRUCK

A













					
<b>RENAULT RVI</b>					
<b>ME 160 [VF6-JE13] [4X4]</b>					
		SET1047 SET1047		I O	
<b>ME 160 [VF6-JE13] [4X2] [4X4]</b>					
	P 821-13/17 P 821-13/17 P 1021-03 P 1021-03 P 1040-F, P 1140-F P 1040-F, P 1140-F P 1041-F, P 1141-F		594/593X 594/593X 594/593X SET1066 SET1049 SET1103 SET1049	I O I O I O I O I	
<b>ME 160/180 [VF6-JE 15] [4X2]</b>					
	E 400-04/14 E 400-04/14 E 408-AA E 408-AA E 408-05/13/15/24 E 408-05/13/15/24 P 821-13/17 P 821-13/17 P 1021-03 P 1021-03 P 1040-F, P 1140-F P 1040-F, P 1140-F P 1041-F, P 1141-F	SET1111 SET1108 SET1114 SET1110 SET1111 SET1108	594/593X 594/593X 594/593X SET1066 SET1049 SET1103 SET1049	I O I O I O I O I O I O I O I	
<b>MIDLINER 120/140/160/200 [GB ONLY]</b>					
	E 400 E 400 E 401-14 E 402-15 E5A22 769-01 769-02 769-05	SET1111 SET1108 SET1107 SET1109 SET1109	SET1089 SET1047 SET1089	I O I O I O I O I O I	
<b>MIDLUM [42B3/4-44T]</b>					
	P 669 P 920 P 920		JLM714149/JLM714110 SET1047 JLM714149/JLM714110	O I O	
<b>MIDLUM [FAB 42B1/2-43C1/2-43T/V]</b>					
	P 920 P 920 P 669		SET1047 JLM714149/JLM714110 JLM714149/JLM714110	I O O	
<b>MIDLUM [FAB 42US-44US-45US]</b>					
	P 920 P 920		SET1047 JLM714149/JLM714110	I O	

									
									
<b>RENAULT RVI</b>									
<b>PA 160/180 MAROC</b>									
	E 400	SET1111		I	-07/90				
	E 400	SET1108		O	-07/90				
	E 400	SET1111		I	08/90 -				
	E 400	SET1108		O	08/90 -				
	E5A-221	SET1113		I	-08/91				
	E5A-221	SET1109		O	-08/91				
	E5A-221	SET1113		I	09/91-03/93				
	E5A-221	SET1109		O	09/91-03/93				
	E5A-221	SET1113		I	04/93 -				
	E5A-221	SET1110		O	04/93 -				
	P 1140/1 D		SET1049	I					
	P 1340/1-A02		SET1166	O					
	P 1340-A02		SET1103	I					
	P 1341-A02		SET1116	O					
	P 769-02		SET1049	I	-02/91				
	P 769-02		SET1047	O	-02/91				
	P 769-02		SET1049	I	03/91 -				
	P 769-02		SET1047	O	03/91 -				
	P 941-A01		SET1049	I	-02/91				
	P 941-A01		SET1049	O	03/91 -				
<b>PC 27 S</b>									
	E 401	SET1110		I	-09/90				
	E 401	SET1107		O	-09/90				
	769-05		SET1089	I	-09/90				
	769-05		33013	O	-09/90				
<b>PP 160/180</b>									
	E 400-06/16	SET1111		I					
	E 400-06/16	SET1108		O					
	E 401-03	SET1110		I					
	E 401-03	SET1107		O					
	769-01		SET1089	I					
	769-01		33013	O					
	P 769-02		SET1049	I					
	P 769-02		SET1047	O					
<b>PREMIUM [6X2] [6X2/4]</b>									
		EK50042		I					
		EK50042		O					
	1340		SET1166	I					
	1340		SET1116	O					
	1342		SET1166	I					
	1345		SET1166	O					
	16902-04		SET1049	I					
	16902-04		SET1103	O					
	16902-05		SET1049	I					
	16902-05		SET1103	O					
<b>PREMIUM [6X2] PUSHER FAB 22A/22C</b>									
	P 1342		SET1191	I					
	P 1345		SET1191	O					

















# APPLICATION LISTINGS - TRUCK

A

				 			
<b>RENAULT RVI</b>							
<b>PREMIUM PT/TR</b>							
	1340 1340 1342 1345 16902-04 16902-04 16902-05 16902-05	EK50042 EK50042		SET1166 SET1116 SET1166 SET1166 SET1049 SET1103 SET1049 SET1103			
<b>PREMIUM PT/TR [4X2]</b>							
	P 1345			SET1191			
<b>PS 130-09/150-09</b>							
	401 401 769 769 SOMA 95 HD SOMA 95 HD	SET1110 SET1107		SET1089 33013 SET1089 33013			03/85 - 03/85 -
<b>PS 150/160</b>							
	E 400-06/16 E 400-06/16 401-03 401-03 R 769-01 R 769-01 R 769-02 R 769-02	SET1111 SET1108 SET1110 SET1107		SET1089 33013 SET1049 SET1047			
<b>PS 150 CARRIER</b>							
	401 401 769 769	SET1110 SET1107		SET1089 33013			-09/90 -09/90 -09/90 -09/90
<b>PX 28/28 T, PX 30/30 T</b>							
	E6A E6A P 1332/ P 1332 B P 1332/ P 1332 B	SET1114 SET1109		SET1169 64432/64708			
<b>PX 30 V/VT</b>							
	E6A-21 E6A-21 PMA 1021/PMA 1321 PMA 1021/PMA 1321 PMA 1032 B/PMA 1532 PMA 1032 B/PMA 1532	SET1114 SET1109		SET109 52375/52618 SET1169 64432/64708			



























						
<b>RENAULT RVI</b>						
<b>PX 40 V/VT/VTS</b>						
	E6A-21 E6A-21 PMA/PR/P1021, PMA 1321 PMA/PR/P1021, PMA 1321 PMA/PR 1321 PMA/PR 1321 PMA/PR/P 1032 B PMA/PR/P 1032 B PMA/P 1532 PMA/P 1532	SET1114 SET1109	SET109 52375/52618 SET109 52375/52618 SET1169 64432/64708 SET1169 64432/64708			
<b>R 310/310 [6X4]</b>						
	E6A E6A E6A PMA/PR 1321 PMA/PR 1321 PMA/P 1532 PMA/P 1532	SET1114 SET1109 SET1114	SET109 52375/52618 SET1169 64432/64708		-14/03/84 -14/03/84 15/03/84 -	
<b>R 310/330/340/365</b>						
	E6A P 1332/PMA/P 1532 P 1332/PMA/P 1532 P 1345 PR 1341 PR 1341	SET1114	SET1169 64432/64708 SET1166 SET1166 SET1116			
<b>R 340 TI</b>						
	E6A-32 E6A-32/E6A-33 E6A-32/33 /1/211/311 E6B-211/311 E84-AG/EG/GG E85-CM E6A-32/33 /1/211/311 E6A-32/33 /1/211/311 E6B-211/311 E6B-211/311 E84-AG/EG/GG E84-AG/EG/GG E 85-CM E 85-CM P 1332, PMA/P 1532 P 1332, PMA/P 1532 P 1345 PMA/PR 1341 PMA/PR 1341	SET1114 SET1114 SET1114 SET1114 SET1114 E6A-32/33 /1/211/311 E6A-32/33 /1/211/311 E6B-211/311 E6B-211/311 E84-AG/EG/GG E84-AG/EG/GG E 85-CM E 85-CM E6A-32/33 /1/211/311 E6A-32/33 /1/211/311 E6B-211/311 E6B-211/311 E84-AG/EG/GG E84-AG/EG/GG E 85-CM E 85-CM P 1332, PMA/P 1532 P 1332, PMA/P 1532 P 1345 PMA/PR 1341 PMA/PR 1341	SET1114 SET1114 SET1114 SET1114 SET1114 E6A-32/33 /1/211/311 E6A-32/33 /1/211/311 E6B-211/311 E6B-211/311 E84-AG/EG/GG E84-AG/EG/GG E 85-CM E 85-CM E6A-32/33 /1/211/311 E6A-32/33 /1/211/311 E6B-211/311 E6B-211/311 E84-AG/EG/GG E84-AG/EG/GG E 85-CM E 85-CM P 1332, PMA/P 1532 P 1332, PMA/P 1532 P 1345 PMA/PR 1341 PMA/PR 1341	SET1169 64432/64708 SET1166 SET1166 SET1116		- 08/91  - 08/91  09/91- 09/91- 09/91- 09/91- 09/93- 09/93- 09/93- 09/93- 09/93- 09/93- 09/93- 09/93- 09/93- 09/93- 09/93- 09/93- 09/93- 09/93- 09/93-
<b>R 350</b>						
	E6A-32 E6A-32/E6A-33 E6 A-32/33 /1/211/311 E6B-211/311	SET1114 SET1114 SET1114 SET1114			- 08/91  - 08/91  09/91- 09/91-	



# APPLICATION LISTINGS - TRUCK

A













					
<b>RENAULT RVI</b>					
<b>R 350 ...</b>					
E84-AG/EG/GG E84-AG/EG/GG E 85-CM/E 85-JH E 85-CM/E 85-JH P 1332, PMA/P 1532 P 1332, PMA/P 1532 P 1345 PMA/PR 1341 PMA/PR 1341	EK50042 EK50042 EK50042 EK50042	SET1169 64432/64708 SET1166 SET1166 SET1116		09/93- 09/93- 09/93- 09/93-	
<b>R 360/360 T [6X4]</b>					
E6A E6A E6A P 1332 B/B1, P 1332, E 42 P 1332 B/B1, P 1332, E 42	SET1114 SET1109 SET1114	SET1169 64432/64708		-14/03/84 -14/03/84 15/03/84-	
<b>R 370</b>					
E6A P 1332 P 1332 P 1345	SET1114	SET1169 64432/64708 SET1166			
<b>R 380</b>					
E6A-32 E6A-32/E6A-33 E6 A-32/33 /1/211/311 E6B-211/311 E84-AG/EG/GG E 85-CM E84-AG/EG/GG E84-AG/EG/GG E 85-CM E 85-CM E 85-CM E 85-JH E 85-JH P 1332, PMA/P 1532 P 1332, PMA/P 1532 P 1345 PMA/PR 1341 PMA/PR 1341	SET1114 SET1114 SET1114 SET1114 SET1114 SET1114 EK50042 EK50042 EK50042 EK50042 EK50042 EK50042	SET1169 64432/64708 SET1166 SET1166 SET1116		- 08/91  - 08/91  09/91- 09/91- 09/91- 09/91- 09/93- 09/93- 09/93- 09/93-	
<b>R 385 TI</b>					
E6A-32 E6A-32/E6A-33 E6 A-32/33 /1/211/311 E6B-211/311 E84-AG/EG/GG E 85-CM E84-AG/EG/GG E84-AG/EG/GG E 85-CM E 85-CM E 85-CM E 85-JH	SET1114 SET1114 SET1114 SET1114 SET1114 SET1114 EK50042 EK50042 EK50042 EK50042	SET1169 64432/64708 SET1166 SET1166 SET1116		- 08/91  - 08/91  09/91- 09/91- 09/91- 09/91- 09/93- 09/93- 09/93- 09/93-	







					
<b>RENAULT RVI</b>					
<b>R 385 TI ...</b>					
	E 85-JH P 1332, PMA/P 1532 P 1332, PMA/P 1532 P 1345 PMA/PR 1341 PMA/PR 1341	<b>EK50042</b>	<b>SET1169</b> <b>64432/64708</b> <b>SET1166</b> <b>SET1166</b> <b>SET1166</b>	O I O I O I O	
<b>R 390</b>					
	E6A P 1332 P 1332 P 1345	<b>SET1114</b>	<b>SET1169</b> <b>64432/64708</b> <b>SET1166</b>	I I O I	
<b>R 390/420 [6X4]</b>					
	E6A P MA/PR 1532 P MA/PR 1532 P MA/PR 1341	<b>SET1114</b>	<b>SET1169</b> <b>64432/64708</b> <b>SET1166</b>	I I O I	
<b>R 390 T / R 420</b>					
	E6A P 1332 P 1332 P 1345	<b>SET1114</b>	<b>SET1169</b> <b>64432/64708</b> <b>SET1166</b>	I I O I	
<b>R 420 T</b>					
	P 1332 P 1332 P 1345		<b>SET1169</b> <b>64432/64708</b> <b>SET1166</b>	I O I	
<b>R 420 TI / R [6X4] TS</b>					
	E6A-32 E6A-32/E6A-33 E6 A-32/33 /1/211/311 E84-AG/EG/GG E6B-211/311 E 85-CM E84-AG/EG/GG E84-AG/EG/GG E 85-CM E 85-CM E 85-CM E 85-JH E 85-JH P 1332, PMA/P 1532 P 1332, PMA/P 1532 P 1345 PMA/PR 1341 PMA/PR 1341	<b>SET1114</b> <b>SET1114</b> <b>SET1114</b> <b>SET1114</b> <b>SET1114</b> <b>SET1114</b> <b>EK50042</b> <b>EK50042</b> <b>EK50042</b> <b>EK50042</b> <b>EK50042</b> <b>EK50042</b> <b>EK50042</b> <b>EK50042</b> <b>EK50042</b> <b>SET1169</b> <b>64432/64708</b> <b>SET1166</b> <b>SET1166</b> <b>SET1166</b>		I I I I I I I I I I O I O I O I O I O	- 08/91   - 08/91   09/91- 09/91- 09/91- 09/91- 09/93- 09/93- 09/93- 09/93- 09/93- 09/93- 09/93- 09/93-
<b>R I 357</b>					
	E6A-32 P 1332, PMA/P 1532 P 1332, PMA/P 1532 P 1345	<b>SET1114</b>	<b>SET1169</b> <b>64432/64708</b> <b>SET1166</b>	I I O I	



# APPLICATION LISTINGS - TRUCK







A









					
<b>RENAULT RVI</b>					
<b>R   357 ...</b>					
	PMA/PR 1341 PMA/PR 1341		SET1166 SET1116		
<b>S 90-09 [VF6-JN]</b>					
	401 401 401 401 SOMA 95 SOMA 95 769-01 769-01	SET1109 32305 SET1110 SET1107	SET1089 33013 SET1089 33013		-02/85 -02/85 03/85 - 03/85 -
<b>S 100 [VF6-JK]</b>					
	401 401 402 402 SOMA 95 SOMA 95 669 669 769 769	SET1110 SET1107 SET1109 SET1106	SET1089 33013 SET1088 SET1087 SET1089 33013		-1986 -1986 1987- 1987-
<b>S 110/130 [VF6-JK]</b>					
	402 402 669 669	SET1109 SET1106	SET1088 SET1087		
<b>S 120/135 [VF6]</b>					
	401 401 401 401 402 402 402 402 669 669 669 669 769 769	SET1110 SET1107 SET1110 SET1107 SET1109 SET1106 SET1109 SET1107	SET1088 SET1087 SET1045 SET1043 SET1089 33013		-02/92 -02/92 03/92- 03/92- -02/92 -02/92 03/92- 03/92- -05/95 -05/95 06/95- 06/95-
<b>S 130-06/08/09 [VF6-JN]</b>					
	401 401 401 401 SOMA 95 SOMA 95	SET1109 32305 SET1110 SET1107	SET1089 33013		-02/85 -02/85 03/85- 03/85-

					
<b>RENAULT RVI</b>					
<b>S 130-06/08/09 [VF6-JN] ...</b>					
	769-01 769-01		SET1089 33013	I O	
<b>S 130/150/170 [VF6-JP]</b>					
	400 400 P 620/P 820 P 620/P 820 P 821 P 821	SET1111 SET1108	SET1090 SET1089 594/593X 594/593X	I O I O I O I O	
<b>S 135/150 [VF6-AE]</b>					
	401 401 402 402 669 669 769 769	SET1110 SET1107 SET1109 SET1107	SET1045 SET1043 SET1089 33013	I O I O I O I O	
<b>S 140/160 [VF-6]</b>					
	401 401 401 401 402 402 402 402 402 669 669 769 769	SET1110 SET1107 SET1110 SET1107 SET1109 SET1106 SET1109 SET1107	SET1088 SET1087 SET1089 33013	I O I O I O I O I O I O I O	
<b>S 150-06/08/09 [VF6-JN]</b>					
	401 401 401 401 SOMA 95 SOMA 95 769-01 769-01	SET1109 32305 SET1110 SET1107	SET1089 33013 SET1089 33013	I O I O I O I O	-02/85 -02/85 03/85- 03/85-
<b>S 150 [VF6-JK-SC, VF6-JN-1E]</b>					
	E 400 E 400 E 401 E 401 E 402 E 402 E5A E5A	SET1111 SET1108 SET1110 SET1107 SET1109 SET1107 SET1113 SET1109		I O I O I O I O	-03/93 -03/93



A







				 			
<b>RENAULT RVI</b>							
<b>S 150 [VF6-JK-SC, VF6-JN-1E] ...</b>							
	E5A	SET1113			I	04/93-	
	E5A	SET1110			O	04/93-	
	669		SET1088		O	-05/95	
	669		SET1087		O	-05/95	
	669		SET1045		O	06/95-	
	669		SET1043		O	06/95-	
	769-02		SET1049		O		
	769-02		SET1047		O		
	769-05		SET1089		O		
	769-05		33013		O		
	769-06		SET1045		O		
	769-06		SET1043		O		
	940		SET1049		O		
	940		SET1047		O		
	941		SET1049		O		
	1140		SET1049		O		
	1140		SET1103		O		
	1141		SET1049		O		
	1340		SET1166		O		
	1340		SET1103		O		
	1341		SET1166		O		
	1341		SET1116		O		
<b>S 150/180 [VF6 40-ACF/ACE]</b>							
	E 400	SET1111			I		
	E 400	SET1108			O		
	E 401	SET1110			O		
	E 401	SET1107			O		
	E 402	SET1109			O		
	E 402	SET1107			O		
	E5A	SET1113			O	-03/93	
	E5A	SET1109			O	-03/93	
	E5A	SET1113			O	04/93-	
	E5A	SET1110			O	04/93-	
	669		SET1088		O	-05/95	
	669		SET1087		O	-05/95	
	669		SET1045		O	06/95-	
	669		SET1043		O	06/95-	
	769-02		SET1049		O		
	769-02		SET1047		O		
	769-05		SET1089		O		
	769-05		33013		O		
	769-06		SET1045		O		
	769-06		SET1043		O		
	940		SET1049		O		
	940		SET1047		O		
	941		SET1049		O		
	1140		SET1049		O		
	1140		SET1103		O		
	1141		SET1049		O		
	1340		SET1166		O		
	1340		SET1103		O		
	1341		SET1166		O		
	1341		SET1116		O		

				 			
<b>RENAULT RVI</b>							
<b>S 170 [4X4]</b>							
	E 408-05	SET1111					
	E 408-05	SET1108					
	SINPAR MD 3000	SET1089					6 M75, - 05/91
	SINPAR MD 3000	SET1045					6 M75, - 05/91
	SINPAR MD 3000	SET1088					6 M70, - 05/91
	SINPAR MD 3000	SET1044					6 M70, - 05/91
	SINPAR MD 4000	SET1048					-05/91
	SINPAR MD 4000	SET1048					-05/91
	SINPAR MD 4000	SET1048					-05/91
	3 MRDIF-155/156/158/171	SET1047					-05/91
	3 MRDIF-155/156/158/171	SET1045					-05/91
	3 MRDIF-214/216/219	SET1047					-05/91
	3 MRDIF-214/216/219	SET1045					-05/91
	3 MRDIF-8274	SET1047					-05/91
	3 MRDIF-8274	SET1047					-05/91
	3 MRDIF-8500 FW	SET1047					-05/91
	3 MRDIF-8500 FW	SET1047					-05/91
	P 1021 K		594/593X			-05/91	
	P 1021 K		SET1066			-05/91	
	P 821/P 1021		594/593X			-05/91	
	P 821/P 1021		594/593X			-05/91	
<b>S 170/220 [VF6-JS]</b>							
	408-05	SET1111					
	408-05	SET1108					
	P 1020		594/593X				07/86-
	P 1020		665X/653X				07/86-
	P 1021		594/593X				
	P 1021		594/593X				
<b>S 210</b>							
	E5A	SET1113					-03/93
	E5A	SET1109					-03/93
	E5A	SET1113					04/93-
	E5A	SET1110					04/93-
	669-03		SET1088				-05/95
	669-03		SET1087				-05/95
	669-03/05		SET1045				
	669-03/05		SET1043				
	769-02		SET1049				
	769-02		SET1047				
	769-05		SET1089				
	769-05		33013				
	769-06		SET1045				
	769-06		SET1043				
	940		SET1049				
	940		SET1047				
	941		SET1049				
	1140		SET1049				
	1140		SET1049				
	1140		SET1103				
	1141		SET1049				
	1340		SET1166				
	1340		SET1103				
	1341		SET1166				
	1341		SET1116				





















# APPLICATION LISTINGS - TRUCK

A

											
<b>RENAULT RVI</b>											
<b>TBH 280 [6X6]</b>											
	PA 721 PA 721 PMA/P 1532 PMA/P 1532	594/593X SET1066		SET1169 64432/64708							
<b>TBH 280 [6X4]/[6X4D]</b>											
	E6A E6A E6A-511 PMA/PR 1032 PMA/PR 1032	SET1114 SET1109 SET1114		SET1169 64432/64708							15/03/84-
<b>TBH 280 [6X6]</b>											
	E6A E6A PKBS 3 PKBS 3 PMA/PR 1032 PMA/PR 1032 PMA/PR 1032 PMA/PR 1032	SET1114 SET1109 SET1048 SET1047		SET1169 64432/64708 SET1169 64432/64708							
<b>TLM 280</b>											
	E6A-51 E6A-51 E6A-51 P 1532 P 1532	SET1114 SET1109 SET1114		SET1169 64432/64708							-14/03/84 -14/03/84 15/03/84-
<b>TR 280/350</b>											
	E6A E6A P 1332 P 1332	SET1114 SET1109		SET1169 64432/64708							
<b>TR 305</b>											
	E6A E6A P 1332/B P 1332/B	SET1114 SET1109		SET1169 64432/64708							
<b>TR 305 [6X4]</b>											
	E6A-21 E6A-21 PMA 102/PMA 1321 PMA 102/PMA 1321 PMA 1032 B/PMA 1532 PMA 1032 B/PMA 1532	SET1114 SET1109		SET109 52375/52618 SET1169 64432/64708							
<b>TRH 350 [6X4], TRH 350 TS</b>											
	E6A-21 E6A-21 PMA/PR 1021, PMA/PR 1321 PMA/PR 1021, PMA/PR 1321	SET1114 SET1109		SET109 52375/52618							

















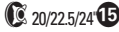









































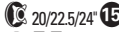





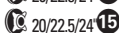









































					
<b>RENAULT RVI</b>					
<b>TRH 350 [6X4], TRH 350 TS ...</b>					
	PMA/PR 1032 B, PMA/P 1532 PMA/PR 1032 B, PMA/P 1532		SET1169 64432/64708	I O	
<b>TRM 2000</b>					
	SOMA 3 MRDIPF 8250 SOMA 3 MRDIPF 8250 SOMA 3 MRDISP 8500 SOMA 3 MRDISP 8500 SOMA 3 MRPF 8250 SOMA 3 MRPF 8250 SOMA 3 MRSP 8500 SOMA 3 MRSP 8500	SET1178 SET1044 SET1178 SET1044	SET1178 SET1044 SET1178 SET1044	I O I O I O I O	- 03/89 - 03/89 04/89 - 04/89 - - 03/89 - 03/89 04/89 - 04/89 -
<b>TRM 4000</b>					
	HWT 1093 HWT 1093 SOMA 12	SET401 SET349	SET1045	I O O	
<b>SAURER</b>					
<b>D 180, D 230, D 230 FK, D 290 F/N, D 330 F</b>					
	6.5-8 T 6.5-8 T 6.5-8 T 6.5-8 T	JH211749/JH211710 SET315	SET1184 SET323	I O I O	
<b>D 330 F [6X2]/[8X4], D 330 N [4X2]/[6X4]</b>					
	6.5-8 T 6.5-8 T 6.5-8 T 6.5-8 T	JH211749/JH211710 SET315	SET1184 SET323	I O I O	
<b>SCANIA</b>					
<b>94 C / D / G / L</b>					
	AM 620 AM 620/AM 920  AM 620/AM 920/AMA 860 AM 820 D AM 900 AM 740/AMA 740/AMA 860  AM 920  AD 1100 AD 1100 AD 1100 P AD 1100 P ADA 1100 ADA 1100 AD 1300/ADA 1300	SET1231 SET1231  SET1231 SET1231 SET1231 SET1231  SET1231	HM218248Z/HM218210 HM218248Z/HM218210 HM218248Z/HM218210 HM218248Z/HM218210 HM218248Z/HM218210 HM218248Z/HM218210 HM218248Z/HM218210	I / O I / O  I / O I / O I / O I / O  I / O  I O I O I O I	 - Ch.9015825SAN  Ch.9015825SAN, 4362207SNL, 1226892SSS-     Ch.9015825SAN, 4362207SNL, 1226892SSS -  Ch.9015825SAN/ 4362207SNL/1226892SSS-  15  15  20/22.5" RP/RBP730  20/22.5" RP/RBP730  20/22.5/24" 15  20/22.5/24" 15



# APPLICATION LISTINGS - TRUCK

A







							
<b>SCANIA</b>							
<b>94 C / D / G / L ...</b>							
	AD 1300/ADA 1300		HM218248Z/HM218210			20/22.5/24	15
	AS 900		HM218248Z/HM218210				15
	AS 900		HM218248Z/HM218210				15
	ASA 1000		HM218248Z/HM218210				15
	ASA 1000		HM218248Z/HM218210				15
	ASA 1000 D		HM218248Z/HM218210				ABS 15
	ASA 1000 D		HM218248Z/HM218210				ABS 15
	AS 1300		HM218248Z/HM218210				15
	AS 1300		HM218248Z/HM218210				15
<b>114 C / G / L</b>							
	AM 620	SET1231				ABS Ch.9015825SAN -	
	AM 620/AM 920	SET1231				ABS Ch.9015825SAN,	
	AM 620/AM 920/AMA 860	SET1231				4362207SNL, 1226892SSS-	
	AM 740/AMA 740	SET1231				Ch.9015825SAN,	
	AM 820 D	SET1231				4362207SNL, 1226892SSS -	
	AM 900	SET1231				ABS	
	AM 920	SET1231				ABS Ch.9015825SAN/	
	ADA		HM218248Z/HM218210			4362207SNL/1226892SSS-	
	ADA		HM218248Z/HM218210			ABS 15	
	ADA 1000		HM218248Z/HM218210			ABS 15	
	ADA 1000		HM218248Z/HM218210			15	
	ADA 1100		HM218248Z/HM218210			20/22.5/24" 15	
	ADA 1100		HM218248Z/HM218210			20/22.5/24" 15	
	AD 1100 P		HM218248Z/HM218210			ABS RP/RBP730	
	AD 1100 P		HM218248Z/HM218210			ABS RP/RBP730	
	AD 1300/ADA 1300		HM218248Z/HM218210			20/22.5/24" 15	
	AD 1300/ADA 1300		HM218248Z/HM218210			20/22.5/24" 15	
	AS 900		HM218248Z/HM218210			ABS 15	
	AS 900		HM218248Z/HM218210			ABS 15	
	AS 900		HM218248Z/HM218210			ABS	
	AS 900		HM218248Z/HM218210			ABS	
	ASA 1000		HM218248Z/HM218210			15	
	ASA 1000		HM218248Z/HM218210			15	
	ASA 1000 D		HM218248Z/HM218210			ABS 15	
	ASA 1000 D		HM218248Z/HM218210			ABS 15	
	AS 1300		HM218248Z/HM218210				
	AS 1300		HM218248Z/HM218210				
<b>124 C / G / L</b>							
	AM 620	SET1231					
	AM 740	SET1231					
	AM 740 D	SET1231					
	AMA 740	SET1231					
	AMA 740 D	SET1231					
	AM 820 D	SET1231					
	AMA 860	SET1231					
	AMA 860 D	SET1231					
	AM 900	SET1231					
	AM 920	SET1231					
	AMD 900	XC8640CD/HM220110					







											
<b>SCANIA</b>											
<b>124 C / G / L ...</b>											
AMD 900		XC8640CD/HM220110									
ADA 1100				HM218248Z/HM218210							
ADA 1100				HM218248Z/HM218210							
ADA 1100				HM218248Z/HM218210							
ADA 1100				HM218248Z/HM218210							
AD 1100 P				HM218248Z/HM218210							
AD 1100 P				HM218248Z/HM218210							
AD 1300				HM218248Z/HM218210							
AD 1300				HM218248Z/HM218210							
AD 1300				HM218248Z/HM218210							
ADA 1300				HM218248Z/HM218210							
ADA 1300				HM218248Z/HM218210							
ADA 1300				HM218248Z/HM218210							
ADA 1300				HM218248Z/HM218210							
AD 1300 D				HM218248Z/HM218210							
AD 1300 D				HM218248Z/HM218210							
AS 900				HM218248Z/HM218210							
AS 900				HM218248Z/HM218210							
AS 900				HM218248Z/HM218210							
AS 900				HM218248Z/HM218210							
ASA 1000				HM218248Z/HM218210							
ASA 1000				HM218248Z/HM218210							
ASA 1000 D				HM218248Z/HM218210							
ASA 1000 D				HM218248Z/HM218210							
AS 1300				HM218248Z/HM218210							
AS 1300				HM218248Z/HM218210							
ASA 80				SET1065							
ASA 80				SET1115							
<b>144C / 144G / 144L</b>											
AM 620		SET1231									
AM 740/AM 740D		SET1231									
AMA 740/AMA 740D		SET1231									
AM 820 D		SET1231									
AMA 860/D		SET1231									
AM 900		SET1231									
AM 920		SET1231									
ADA 1100				HM218248Z/HM218210							
ADA 1100				HM218248Z/HM218210							
ADA 1100				HM218248Z/HM218210							
ADA 1100				HM218248Z/HM218210							
ADA 1100				HM218248Z/HM218210							
AD 1100 P				HM218248Z/HM218210							
AD 1100 P				HM218248Z/HM218210							
AD 1100 P				HM218248Z/HM218210							
AD 1100 P				HM218248Z/HM218210							
ADA 1300 D				HM218248Z/HM218210							
ADA 1300 D				HM218248Z/HM218210							
AD 1300/ADA 1300				HM218248Z/HM218210							
AD 1300/ADA 1300				HM218248Z/HM218210							
AD 1300/ADA 1300				HM218248Z/HM218210							
AD 1300/ADA 1300				HM218248Z/HM218210							



# APPLICATION LISTINGS - TRUCK















































































A

													
<b>SCANIA</b>													
<b>144C / 144G / 144L ...</b>													
	AS 900				HM218248Z/HM218210		I						15
	AS 900				HM218248Z/HM218210		O						15
	ASA 1000				HM218248Z/HM218210		I						15
	ASA 1000				HM218248Z/HM218210		O						15
	ASA 1000				HM218248Z/HM218210		I						ABS 15
	ASA 1000				HM218248Z/HM218210		O						ABS 15
	AS 1300				HM218248Z/HM218210		I						15
	AS 1300				HM218248Z/HM218210		O						15
	ASA 70				SET1165		I						ABS
	ASA 80				SET1065		I						ABS
	ASA 80				SET1115		O						ABS
<b>G/P 82</b>													
	AM 55		SET1080				I						⊗ -Ch.1097602SSS, 4246024SN
	AM 55		SET1076				O						⊗ -Ch.1097602SSS, 4246024SN
	AM 55		SET1080				I						⊗ Ch.1097603SSS/4238514SN -
	AM 55		SET1076				O						⊗ Ch.1097603SSS/4238514SN -
	AM 55		SET1080				I						⊗ -Ch.1105665SSS, 4238514SN
	AM 55		SET1076				O						⊗ -Ch.1105665SSS, 4238514SN
	AM 55		SET1080				I						⊗ Ch.1105666SSS/4238515SN -
	AM 55		SET1076				O						⊗ Ch.1105666SSS/4238515SN -
	AM 60		SET1081				I						
	AM 60		SET1078				O						
	AD 80				SET1065		I						⊗
	AD 80				SET1115		O						⊗
	AD 80				SET1065		I						⊗
	AD 80				SET1064		O						⊗
	AD 90/ADA 90				HM218248Z/HM218210		I						⊗ 15
	AD 90/ADA 90				HM218248Z/HM218210		O						⊗ 15
	AD 90/ADA 90				HM218248Z/HM218210		I						⊗ 2300mm wide ch. 15
	AD 90/ADA 90				HM218248Z/HM218210		O						⊗ 2300mm wide ch. 15
	AD 90/ADA 90				SET1067		I						⊗ 20/22.5", -Ch.1103187SSS, 4248317SN
	AD 90/ADA 90				SET1067		O						⊗ 20/22.5", -Ch.1103187SSS, 4248317SN
	4248317SN						I						⊗ 20/22.5", Ch.1103188SSS, 4248318SN-14 - 15
	AD 90/ADA 90				HM218248Z/HM218210		O						⊗ 20/22.5", Ch.1103188SSS, 4248318SN-14 - 15
	AD 90/ADA 90						I						⊗ 24" 15
	AD 90/ADA 90				SET1067		O						⊗ 24" 15
	TRAILING AXLE/ASA 60				SET1081		I						
	TRAILING AXLE/ASA 60				SET1078		O						
	TRAILING AXLE/ASA 70				SET1165		I						
<b>G/P 82 H [6X2]</b>													
	TRAILING AXLE				HM218248Z/HM218210		I						⊗
	TRAILING AXLE				HM218248Z/HM218210		O						⊗
	TRAILING AXLE				HM218248Z/HM218210		I						15
	TRAILING AXLE				HM218248Z/HM218210		O						15
	TRAILING AXLE				SET1067		I						⊗
	TRAILING AXLE				SET1067		O						⊗

											
<b>SCANIA</b>											
<b>G/P 82 M [6X2]</b>											
	TRAILING AXLE			SET1081				I			
	TRAILING AXLE			SET1078				O			
<b>G 92, P 92 /M/H</b>											
	AM 55	SET1080						I	⊗	-Ch.1097602SSS, 4246024SN	
	AM 55	SET1076						O	⊗	-Ch.1097602SSS, 4246024SN	
	AM 55	SET1080						I	⊗	Ch.1097603SSS/4238514SN -	
	AM 55	SET1076						O	⊗	Ch.1097603SSS/4238514SN -	
	AM 55	SET1080						I	⊗	-Ch.1105665SSS, 4238514SN	
	AM 55	SET1076						O	⊗	-Ch.1105665SSS, 4238514SN	
	AM 55	SET1080						I	⊗	Ch.1105666SSS, 4238515SN-101 -	
	AM 55	SET1076						O	⊗	Ch.1105666SSS, 4238515SN-101 -	
	AM 60	SET1081						I			
	AM 60	SET1078						O			
	AD 80			SET1065				I	⊗		
	AD 80			SET1115				O	⊗		
	AD 80			SET1065				I	⊗		
	AD 80			SET1064				O	⊗		
	AD 90			HM218248Z/HM218210				I	⊗	2300mm wide ch. 15	
	AD 90			HM218248Z/HM218210				O	⊗	2300mm wide ch. 15	
	AD 90			SET1067				I	⊗	24" C	
	AD 90			SET1067				O	⊗	24" C	
	AD 90			HM218248Z/HM218210				I	⊗	20/22" C Ch.1033188SSS/4248318SN - 15	
	AD 90			HM218248Z/HM218210				O	⊗	20/22" C Ch.1033188SSS/4248318SN - 15	
	AD 90/ADA 90			SET1067				I	⊗	20/22" C -Ch.1103187SSS, 428317SN	
	AD 90/ADA 90			SET1067				O	⊗	20/22" C -Ch.1103187SSS, 428317SN	
	AD 90/ADA 90			HM218248Z/HM218210				I	⊗	15	
	AD 90/ADA 90			HM218248Z/HM218210				O	⊗	15	
	TRAILING AXLE/ASA 60			SET1081				I	⊗		
	TRAILING AXLE/ASA 60			SET1078				O	⊗		
	TRAILING AXLE/ASA 70			SET1165				I	⊗		
<b>G/P/R 92 H [6X2]</b>											
	TRAILING AXLE/AS 90			SET1067				I	⊗		
	TRAILING AXLE/AS 90			SET1067				O	⊗		
<b>G/P 92 M [6X2]</b>											
	TRAILING AXLE			SET1081				I	⊗		
	TRAILING AXLE			SET1078				O	⊗		
<b>G/P 92 [6X2] [6X4]</b>											
	TRAILING AXLE/ASA 60			SET1081				I			
	TRAILING AXLE/ASA 60			SET1078				O			
	TRAILING AXLE/ASA 70			SET1165				I			
	TRAILING AXLE/ARA 55			SET1080				I			
	TRAILING AXLE/ARA 55			SET1076				O			















											
<b>SCANIA</b>											
<b>G/P/R 112 ...</b>											
	AD 100 AD 100 ARA 55 ARA 55 TRAILING AXLE/ASA 60 TRAILING AXLE/ASA 60 TRAILING AXLE/ASA 70			HM220149Z/HM220110Z HM220149Z/HM220110Z SET1080 SET1076 SET1081 SET1078 SET1165							
<b>G/P/R 112 M</b>											
	AM 55 AM 55 AM 55 AM 55 AM 55 AM 55 AM 55 AM 55 AM 70 AD 80 AD 80 AD 80 AD 80	SET1080 SET1076 SET1080 SET1076 SET1080 SET1076 SET1080 SET1076 SET1165		SET1065 SET1115 SET1065 SET1064						 -Ch.1097602SSS, 4246024SN  -Ch.1097602SSS, 4246024SN  Ch.1097603SSS/4238514SN -  Ch.1097603SSS/4238514SN -  -Ch.1105666SSS, 4238514SN  -Ch.1105666SSS, 4238514SN  Ch.1105666SSS/4238515SN -  Ch.1105666SSS/4238515SN -   24"                                	
<b>L/LB 80</b>											
			SET1076								Ch.1032242 -
<b>L/LB 81</b>											
	AM 55 AM 55 AM 60 AM 60 R 640 R 640 R 640 R 640 R 640 R 640	SET1080 SET1076 SET1081 SET1078		SET1065 SET1064 SET1065 SET1115 SET1065 SET1064							Ch.1032242 - Ch.1032242 -   -Ch.1032241  -Ch.1032241  Ch.1032242 -  Ch.1032242 -                    
<b>L 85</b>											
	R 650/RD 650/R651/R751 R 650/RD 650/R651/R751		SET1076	SET1067 SET1067							
<b>L 86</b>											
	AM 55 AM 55 AM 60 AM 60 R 651/R 653/R 751/R 752 R 651/R 653/R 751/R 752 R 651/R 653/R 751/R 752 R 651/R 653/R 751/R 752 R 651/R 653/R 751/R 752 R 651/R 653/R 751/R 752 R 651/R 653/R 751/R 752	SET1080 SET1076 SET1081 SET1078		HM218248Z/HM218210 HM218248Z/HM218210 SET1067 SET1067 SET1067 SET1067							-Ch.1032241 -Ch.1032241   Ch.1033748- <b>15</b>  Ch.1033748- <b>15</b>  -Ch.1033747  -Ch.1033747      













# APPLICATION LISTINGS - TRUCK

A

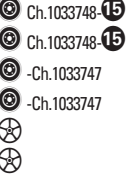
				 			
<b>SCANIA</b>							
<b>L 110</b>							
	R 650/RD 650/R 651/R 751 R 650/RD 650/R 651/R 751 RP 750 RP 750	SET1076	SET1067 SET1067 SET1068 SET1068				
<b>L 111</b>							
	AM 55 AM 55 AM 60 AM 60 AD 90 AD 90 AD 90 AD 90 AD 90 AD 90 AD 90 AD 90 AD 95 AD 95 AD 100 AD 100	SET1080 SET1076 SET1081 SET1078	HM218248Z/HM218210 HM218248Z/HM218210 SET1067 SET1067 HM218248Z/HM218210 HM218248Z/HM218210 SET1067 SET1067 SET1068 SET1068 HM220149Z/HM220110Z HM220149Z/HM220110Z		Ch.1032242 - Ch.1032242 -	⊗ Ch.1033748-15 ⊗ Ch.1033748-15 ⊗ -Ch.1033747 ⊗ -Ch.1033747 ⊗ 2300mm wide ch. 15 ⊗ 2300mm wide ch. 15 ⊗ ⊗	
<b>L/LS 140, LT 145</b>							
	RP 751 RP 751 R 651/RPB 652/RP 750 R 651/RPB 652/RP 750 TRAILING AXLE TRAILING AXLE	SET1081 SET1078	SET1067 SET1067 SET1068 SET1068 SET1067 SET1067				
<b>L 141</b>							
	AD 90 AD 90 AD 90 AD 90 AD 90 AD 90 AD 95 AD 95 AD 100 AD 100	SET1081 SET1078	SET1067 SET1067 HM218248Z/HM218210 HM218248Z/HM218210 SET1067 SET1067 SET1068 SET1068 HM220149Z/HM220110Z HM220149Z/HM220110Z		-Ch.1033747 -Ch.1033747 ⊗ Ch.1033748-15 ⊗ Ch.1033748-15 ⊗ ⊗		
<b>LB 85</b>							
	R 650/RD 650/R651/R751 R 650/RD 650/R651/R751	SET1081 SET1078	SET1067 SET1067				

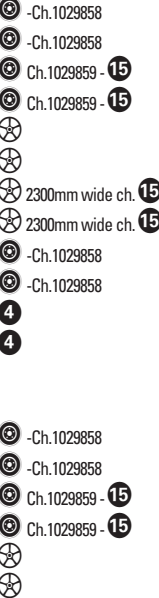















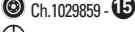



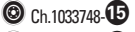

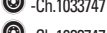













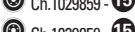
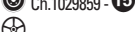

























					
<b>SCANIA</b>					
<b>LB 86</b>					
	AM 60 AM 60 R 651/R 653/R 751/R 752 R 651/R 653/R 751/R 752 R 651/R 653/R 751/R 752 R 651/R 653/R 751/R 752 R 651/R 653/R 751/R 752 R 651/R 653/R 751/R 752	SET1081 SET1078	HM218248Z/HM218210 HM218248Z/HM218210 SET1067 SET1067 SET1067 SET1067		 Ch.1033748-15 Ch.1033748-15 -Ch.1033747 -Ch.1033747
<b>LB 110</b>					
	R 650/RD 650/R 651/R 751 R 650/RD 650/R 651/R 751 RP 750 RP 750	SET1081 SET1078	SET1067 SET1067 SET1068 SET1068		
<b>LB 111</b>					
	AM 60 AM 60 AD 90 AD 90 AD 90 AD 90 AD 90 AD 90 AD 90 AD 90 AD 95 AD 95 AD 95 AD 95 AD 100 AD 100 TRAILING AXLE TRAILING AXLE TRAILING AXLE TRAILING AXLE TRAILING AXLE TRAILING AXLE	SET1081 SET1078	SET1067 SET1067 HM218248Z/HM218210 HM218248Z/HM218210 SET1067 SET1067 HM218248Z/HM218210 HM218248Z/HM218210 SET1068 SET1068 SET1068 SET1068 HM220149Z/HM220110Z HM220149Z/HM220110Z SET1067 SET1067 HM218248Z/HM218210 HM218248Z/HM218210 SET1067 SET1067		 -Ch.1029858 -Ch.1029858 Ch.1029859-15 Ch.1029859-15 2300mm wide ch. 15 2300mm wide ch. 15 -Ch.1029858 -Ch.1029858 4 4 -Ch.1029858 -Ch.1029858 Ch.1029859-15 Ch.1029859-15
<b>LB 140</b>					
	R 651/R 652/RB 652 R 651/R 652/RB 652 RBP 652/R 752 RBP 652/R 752 R 750 R 750	SET1081 SET1078	SET1067 SET1067 SET1067 SET1067 SET1068 SET1068		



# APPLICATION LISTINGS - TRUCK

A





















































































									
<b>SCANIA</b>									
<b>LB 141</b>									
	AD 90 AD 90 AD 90 AD 90 AD 95 AD 95 AD 100 AD 100		SET1081 SET1078		HM218248Z/HM218210 HM218248Z/HM218210 SET1067 SET1067 SET1068 SET1068 HM220149Z/HM220110Z HM220149Z/HM220110Z				   
<b>LBS 85</b>									
	R 650/RD 650/R651/R751 R 650/RD 650/R651/R751 TRAILING AXLE TRAILING AXLE		SET1081 SET1078		SET1067 SET1067 SET1067 SET1067				
<b>LBS 86</b>									
	AM 60 AM 60 R 651/R 653/R 751/R 752 R 651/R 653/R 751/R 752 R 651/R 653/R 751/R 752 R 651/R 653/R 751/R 752 R 651/R 653/R 751/R 752 R 651/R 653/R 751/R 752 TRAILING AXLE TRAILING AXLE TRAILING AXLE TRAILING AXLE TRAILING AXLE TRAILING AXLE		SET1081 SET1078		HM218248Z/HM218210 HM218248Z/HM218210 SET1067 SET1067 SET1067 SET1067 SET1067 SET1067 SET1067 SET1067 SET1067 HM218248Z/HM218210 HM218248Z/HM218210				           
<b>LBS 110</b>									
	R 650/RD 650/R 651/R 751 R 650/RD 650/R 651/R 751 RP 750 RP 750 TRAILING AXLE TRAILING AXLE		SET1081 SET1078		SET1067 SET1067 SET1068 SET1068 SET1067 SET1067				
<b>LBS 111</b>									
	AM 60 AM 60 AD 90 AD 90 AD 90 AD 90 AD 90 AD 90		SET1081 SET1078		SET1067 SET1067 HM218248Z/HM218210 HM218248Z/HM218210 SET1067 SET1067				     











											
<b>SCANIA</b>											
<b>LBS 111 ...</b>											
	AD 95 AD 95 AD 95 AD 95 AD 100 AD 100 TRAILING AXLE TRAILING AXLE TRAILING AXLE TRAILING AXLE TRAILING AXLE TRAILING AXLE		SET1068 SET1068 SET1068 SET1068 HM220149Z/HM220110Z HM220149Z/HM220110Z SET1067 SET1067 HM218248Z/HM218210 HM218248Z/HM218210 SET1067 SET1067								 -Ch.1029858  -Ch.1029858  4  4   -Ch.1029858  -Ch.1029858  Ch.1029859 - 15  Ch.1029859 - 15  
<b>LBS 140</b>											
	R 651/R 652/RB 652 R 651/R 652/RB 652 RBP 652/R 752 RBP 652/R 752 R 750 R 750 TRAILING AXLE TRAILING AXLE	SET1081 SET1078	SET1067 SET1067 SET1067 SET1067 SET1068 SET1068 SET1067 SET1067								
<b>LBS 141</b>											
	AD 90 AD 90 AD 90 AD 90 AD 95 AD 95 AD 100 AD 100 TRAILING AXLE TRAILING AXLE TRAILING AXLE TRAILING AXLE TRAILING AXLE TRAILING AXLE	SET1081 SET1078	HM218248Z/HM218210 HM218248Z/HM218210 SET1067 SET1067 SET1068 SET1068 HM220149Z/HM220110Z HM220149Z/HM220110Z SET1067 SET1067 HM218248Z/HM218210 HM218248Z/HM218210 SET1067 SET1067								 Ch.1029859 - 15  Ch.1029859 - 15     -Ch.1029858  -Ch.1029858  Ch.1029859 - 15  Ch.1029859 - 15  
<b>LBT 111</b>											
	AM 60 AM 60	SET1081 SET1078									
<b>LBT 111 BB</b>											
	AD 90 AD 90 AD 90 AD 90 AD 90 AD 90		SET1067 SET1067 HM218248Z/HM218210 HM218248Z/HM218210 SET1067 SET1067								 -Ch.1029858  -Ch.1029858  Ch.1029859 - 15  Ch.1029859 - 15  



# APPLICATION LISTINGS - TRUCK

A









				 			
<b>SCANIA</b>							
<b>LBT 111 BB ...</b>							
	AD 90		HM218248Z/HM218210			2300mm wide ch. <b>15</b>	
	AD 90		HM218248Z/HM218210			2300mm wide ch. <b>15</b>	
<b>LBT 111 FB</b>							
	AD 80		SET1065			-Ch.1029858	
	AD 80		SET1064			-Ch.1029858	
	AD 80		SET1065			Ch.1029859 -	
	AD 80		SET1115			Ch.1029859 -	
	AD 80		SET1065				
	AD 80		SET1064				
	AD 90		SET1067			-Ch.1029858	
	AD 90		SET1067			-Ch.1029858	
	AD 90		HM218248Z/HM218210			Ch.1029859 - <b>15</b>	
	AD 90		HM218248Z/HM218210			Ch.1029859 - <b>15</b>	
	AD 90		SET1067				
	AD 90		SET1067				
<b>LBT 140</b>							
		SET1081 SET1078					
	R 651/R 652/RB 652		SET1067				
	R 651/R 652/RB 652		SET1067				
	RBP 652/R 752		SET1067				
	RBP 652/R 752		SET1067				
<b>LBT 141</b>							
		SET1081 SET1078					
							
<b>LBT 141 BB</b>							
	AD 90		HM218248Z/HM218210			Ch.1029859 - <b>15</b>	
	AD 90		HM218248Z/HM218210			Ch.1029859 - <b>15</b>	
	AD 90		SET1067				
	AD 90		SET1067				
	AD 95		SET1068			<b>4</b>	
	AD 95		SET1068			<b>4</b>	
	AD 95		SET1068				
	AD 95		SET1068				
	AD 100		HM220149Z/HM220110Z				
	AD 100		HM220149Z/HM220110Z				
<b>LBT 141 FB</b>							
	AD 80		SET1065			-Ch.1029858	
	AD 80		SET1064			-Ch.1029858	
	AD 80		SET1065			Ch.1029859 -	
	AD 80		SET1115			Ch.1029859 -	
	AD 80		SET1065				
	AD 80		SET1064				
	AD 90		SET1067			-Ch.1029858	
	AD 90		SET1067			-Ch.1029858	
	AD 90		HM218248Z/HM218210			Ch.1029859 - <b>15</b>	
	AD 90		HM218248Z/HM218210			Ch.1029859 - <b>15</b>	
	AD 90		SET1067				
	AD 90		SET1067				







					
<b>SCANIA</b>					
<b>LS 85</b>					
	R 650/RD 650/R651/R751 R 650/RD 650/R651/R751 TRAILING AXLE TRAILING AXLE	SET1076	SET1067 SET1067 SET1067 SET1067		
<b>LS 86</b>					
	AM 55 AM 55 AM 60 AM 60 R 651/R 653/R 751/R 752 R 651/R 653/R 751/R 752 R 651/R 653/R 751/R 752 R 651/R 653/R 751/R 752 R 651/R 653/R 751/R 752 R 651/R 653/R 751/R 752 TRAILING AXLE TRAILING AXLE TRAILING AXLE TRAILING AXLE TRAILING AXLE TRAILING AXLE	SET1080 SET1076 SET1081 SET1078	HM218248Z/HM218210 HM218248Z/HM218210 SET1067 SET1067 SET1067 SET1067 SET1067 SET1067 SET1067 SET1067 SET1067 HM218248Z/HM218210 HM218248Z/HM218210		Ch.1032242 - Ch.1032242 - Ch.1033748-15 Ch.1033748-15 -Ch.1033747 -Ch.1033747 -Ch.1033747 -Ch.1033747 -Ch.1033747 -Ch.1033747 Ch.1033748 - Ch.1033748 -
<b>LS 110</b>					
	R 650/RD 650/R 651/R 751 R 650/RD 650/R 651/R 751 RP 750 RP 750 TRAILING AXLE TRAILING AXLE	SET1076	SET1067 SET1067 SET1068 SET1068 SET1067 SET1067		
<b>LS 111</b>					
	AM 55 AM 55 AM 60 AM 60 AD 90 AD 90 AD 90 AD 90 AD 95 AD 95 AD 100 AD 100 TRAILING AXLE TRAILING AXLE TRAILING AXLE TRAILING AXLE TRAILING AXLE TRAILING AXLE	SET1080 SET1076 SET1081 SET1078	HM218248Z/HM218210 HM218248Z/HM218210 SET1067 SET1067 SET1068 SET1068 HM220149Z/HM220110Z HM220149Z/HM220110Z SET1067 SET1067 HM218248Z/HM218210 HM218248Z/HM218210 SET1067 SET1067		Ch.1032242 - Ch.1032242 - Ch.1033748-15 Ch.1033748-15 -Ch.1033747 -Ch.1033747 -Ch.1033747 -Ch.1033747 -Ch.1033747 -Ch.1033747 Ch.1033748-15 Ch.1033748-15



# APPLICATION LISTINGS - TRUCK









A

									
<b>SCANIA</b>									
<b>LS 141</b>									
	AD 90 AD 90 AD 90 AD 90 AD 90 AD 90 AD 95 AD 95 AD 100 AD 100 TRAILING AXLE TRAILING AXLE TRAILING AXLE TRAILING AXLE TRAILING AXLE TRAILING AXLE	SET1081 SET1078	SET1067 SET1067 HM218248Z/HM218210 HM218248Z/HM218210 SET1067 SET1067 SET1068 SET1068 HM220149Z/HM220110Z HM220149Z/HM220110Z SET1067 SET1067 HM218248Z/HM218210 HM218248Z/HM218210 SET1067 SET1067		-Ch.1033747 -Ch.1033747 Ch.1033748-15 Ch.1033748-15 -Ch.1033747 -Ch.1033747 Ch.1033748-15 Ch.1033748-15				
<b>LT 110</b>									
	R 650/RD 650/R 651/R 751 R 650/RD 650/R 651/R 751	SET1076	SET1067 SET1067						
<b>LT 111</b>									
	AM 55 AM 55 AM 60 AM 60 AD 90 AD 90 AD 90 AD 90 AD 90 AD 90 AD 90 AD 95 AD 95 AD 95 AD 95 AD 100 AD 100	SET1080 SET1076 SET1081 SET1078	HM218248Z/HM218210 HM218248Z/HM218210 SET1067 SET1067 HM218248Z/HM218210 HM218248Z/HM218210 SET1067 SET1067 SET1068 SET1068 SET1068 SET1068 HM220149Z/HM220110Z HM220149Z/HM220110Z		Ch.1032242 - Ch.1032242 - Ch.1033748-15 Ch.1033748-15 -Ch.1033747 -Ch.1033747 2300mm wide ch. 15 2300mm wide ch. 15 3 3 4 4				
<b>LT 146</b>									
	AD 95 AD 95 AD 100 AD 100	SET1081 SET1078	SET1068 SET1068 HM220149Z/HM220110Z HM220149Z/HM220110Z						







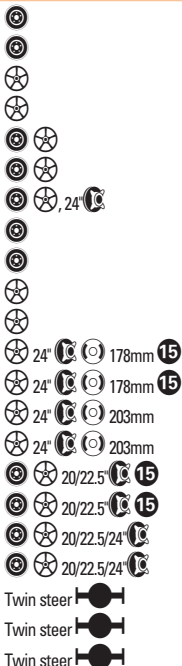

























											
<b>SCANIA</b>											
<b>P 82 M/H</b>											
	AM 55	SET1080		I	⊗ -Ch.1097602SSS, 4246024SN						
	AM 55	SET1076		O	⊗ -Ch.1097602SSS, 4246024SN						
	AM 55	SET1080		I	⊗ Ch.1097603SSS/4238514SN -						
	AM 55	SET1076		O	⊗ Ch.1097603SSS/4238514SN -						
	AM 55	SET1080		I	⊗ -Ch.1105666SSS, 4238514SN						
	AM 55	SET1076		O	⊗ -Ch.1105666SSS, 4238514SN						
	AM 55	SET1080		I	⊗ Ch.1105666SSS/4238515SN -						
	AM 55	SET1076		O	⊗ Ch.1105666SSS/4238515SN -						
	AM 60	SET1081		I							
	AM 60	SET1078		O							
	AD 80		SET1065	I	⊗						
	AD 80		SET1115	O	⊗						
	AD 80		SET1065	I	⊗						
	AD 80		SET1064	O	⊗						
	AD 90/ADA 90		HM218248Z/HM218210	I	⊗ 15						
	AD 90/ADA 90		HM218248Z/HM218210	O	⊗ 15						
	AD 90/ADA 90		HM218248Z/HM218210	I	⊗ 2300mm wide ch. 15						
	AD 90/ADA 90		HM218248Z/HM218210	O	⊗ 2300mm wide ch. 15						
	AD 90/ADA 90		SET1067	I	⊗ 20/22.5", -Ch.1103187SSS, 4248317SN						
	AD 90/ADA 90		SET1067	O	⊗ 20/22.5", -Ch.1103187SSS, 4248317SN						
	AD 90/ADA 90		HM218248Z/HM218210	I	⊗ 20/22.5", Ch.1103188SSS, 4248318SN-14 -15						
	AD 90/ADA 90		HM218248Z/HM218210	O	⊗ 20/22.5", Ch.1103188SSS, 4248318SN-14 -15						
	AD 90/ADA 90		SET1067	I	⊗ 24" 15						
	AD 90/ADA 90		SET1067	O	⊗ 24" 15						
<b>P 92 H [6X2]</b>											
	TRAILING AXLE AS 90		HM218248Z/HM218210	I	⊗ 15						
	TRAILING AXLE AS 90		HM218248Z/HM218210	O	⊗ 15						
<b>P 112 H/E, R 112 H/E</b>											
	AM 55	SET1080		I	⊗ -Ch.1097602SSS, 4246024SN						
	AM 55	SET1076		O	⊗ -Ch.1097602SSS, 4246024SN						
	AM 55	SET1080		I	⊗ Ch.1097603SSS/4238514SN -						
	AM 55	SET1076		O	⊗ Ch.1097603SSS/4238514SN -						
	AM 55	SET1080		I	⊗ -Ch.1105666SSS, 4238514SN						
	AM 55	SET1076		O	⊗ -Ch.1105666SSS, 4238514SN						
	AM 55	SET1080		I	⊗ Ch.1105666SSS/4238515SN -						
	AM 55	SET1076		O	⊗ Ch.1105666SSS/4238515SN -						
<b>P/R 112 H [6X2]</b>											
	TRAILING AXLE/AS 90		HM218248Z/HM218210	I	⊗ 15						
	TRAILING AXLE/AS 90		HM218248Z/HM218210	O	⊗ 15						
	TRAILING AXLE/AS 90		SET1067	I	⊗						
	TRAILING AXLE/AS 90		SET1067	O	⊗						
<b>P/R 112 M [6X2]</b>											
	TRAILING AXLE/ASA 60		SET1081	I							
	TRAILING AXLE/ASA 60		SET1078	O							



A

				 			
<b>SCANIA</b>							
<b>P/R/T 113, P 113 H/E/M</b>							
AM 56 AM 56 AM 56 AM 56 AM 61 AM 61 AM 70 AD 80 AD 80 AD 80 AD 80 AD 90/ADA 90 AD 90/ADA 90 AD 90/ADA 90 AD 90/ADA 90 AD 90/ADA 90 AD 90/ADA 90 AD 100 AD 100 ARA 56 ARA 56 ARA 61 ARA 61 TRAILING AXLE/AS 60 TRAILING AXLE/AS 60 TRAILING AXLE/ASA 70 TRAILING AXLE/ASA 80 TRAILING AXLE/ASA 80 TRAILING AXLE/AS 90 TRAILING AXLE/AS 90	SET1163 SET1078 SET1081 SET1078 SET1081 SET1078 SET1165	SET1065 SET1115 SET1065 SET1064 SET1067 SET1067 SET1067 SET1067 HM218248Z/HM218210 HM218248Z/HM218210 HM218248Z/HM218210 HM218248Z/HM218210 SET1163 SET1078 SET1081 SET1078 SET1081 SET1078 SET1165 SET1065 SET1115 SET1065 SET1064 SET1067 SET1067 SET1067 HM218248Z/HM218210 HM218248Z/HM218210 HM218248Z/HM218210 SET1163 SET1078 SET1081		 <p>                     24" 15                      24" 15                      24" 203mm                      24" 203mm                      20/22.5 15                      20/22.5 15                      20/22.5/24                      20/22.5/24                      Twin steer                      Twin steer                      Twin steer                      Twin steer                      15                      15                 </p>			
<b>R 113 H/E/M, T 113 H/E</b>							
AM 56 AM 56 AM 56 AM 56 AM 61 AM 61 AM 70 AD 80 AD 80 AD 80 AD 80 AD 90/ADA 90 AD 90/ADA 90 AD 90/ADA 90 AD 90/ADA 90 AD 90/ADA 90 AD 90/ADA 90 AD 100 AD 100 ARA 56 ARA 56 ARA 61	SET1163 SET1078 SET1081 SET1078 SET1081 SET1078 SET1165	SET1065 SET1115 SET1065 SET1064 SET1067 SET1067 SET1067 SET1067 HM218248Z/HM218210 HM218248Z/HM218210 HM218248Z/HM218210 HM218248Z/HM218210 SET1163 SET1078 SET1081		 <p>                     24" 15                      24" 15                      24" 203mm                      24" 203mm                      20/22.5 15                      20/22.5 15                      20/22.5/24                      20/22.5/24                      Twin steer                      Twin steer                      Twin steer                 </p>			















































































































































































































											
<b>SCANIA</b>											
<b>R 113 H/E/M, T 113 H/E ...</b>											
	ARA 61 TRAILING AXLE/AS 60 TRAILING AXLE/AS 60 TRAILING AXLE/ASA 70 TRAILING AXLE/ASA 80 TRAILING AXLE/ASA 80 TRAILING AXLE/AS 90 TRAILING AXLE/AS 90		SET1078 SET1081 SET1078 SET1165 SET1065 SET1115 HM218248Z/HM218210 HM218248Z/HM218210								Twin steer 
<b>R 142 M [4X2] / R 142 H/E</b>											
	AM 55 AM 55 AM 55 AM 55 AM 55 AM 55 AM 55 AM 55	SET1080 SET1076 SET1080 SET1076 SET1080 SET1076 SET1080 SET1076									 -Ch.1097602SSS, 4246024SN  -Ch.1097602SSS, 4246024SN  Ch.1097603SSS/4238514SN -  Ch.1097603SSS/4238514SN -  Ch.1105665SSS, 4238514SN  Ch.1105665SSS, 4238514SN  Ch.1105666SSS/4238515SN -  Ch.1105666SSS/4238515SN -
<b>R 142 [4X2] [6X4]</b>											
	AM 60 AM 60 AM 70 AD 90/ADA 90 AD 90/ADA 90 AD 90/ADA 90 AD 90/ADA 90 AD 90/ADA 90 AD 90/ADA 90 AD 90/ADA 90 AD 90/ADA 90 AD 90/ADA 90 AD 90/ADA 90 AD 100 AD 100 ARA 55 ARA 55 TRAILING AXLE/ASA 60 TRAILING AXLE/ASA 60 TRAILING AXLE/ASA 70	SET1081 SET1078 SET1165	HM218248Z/HM218210 HM218248Z/HM218210 HM218248Z/HM218210 HM218248Z/HM218210 SET1067 SET1067 SET1067 HM218248Z/HM218210 HM218248Z/HM218210 HM220149Z/HM220110Z HM220149Z/HM220110Z SET1080 SET1076 SET1081 SET1078 SET1165							 15  15  2300mm wide ch. 15  2300mm wide ch. 15  20/22.5", -Ch.1103187SSS, 4248317SN  20/22.5", -Ch.1103187SSS, 4248317SN  24"   24"   20/22.5", Ch.1103188SSS, 4248318SN-14 -15  20/22.5", Ch.1103188SSS, 4248318SN-14 -15	
<b>R 142 [6X2]</b>											
	AM 60 AM 60 AM 70 AD 90/ADA 90 AD 90/ADA 90 AD 90/ADA 90 AD 90/ADA 90 AD 90/ADA 90	SET1081 SET1078 SET1165	HM218248Z/HM218210 HM218248Z/HM218210 HM218248Z/HM218210 HM218248Z/HM218210 SET1067								 15  15  2300mm wide ch. 15  2300mm wide ch. 15  20/22.5", -Ch.1103187SSS,



# APPLICATION LISTINGS - TRUCK

A









































































					
<b>SCANIA</b>					
<b>R 142 [6X2] ...</b>					
4248317SN AD 90/ADA 90 4248317SN AD 90/ADA 90 AD 90/ADA 90 AD 90/ADA 90  AD 90/ADA 90  AD 100 AD 100 ARA 55 ARA 55 TRAILING AXLE/ASA 60 TRAILING AXLE/ASA 60 TRAILING AXLE/ASA 70 TRAILING AXLE TRAILING AXLE			SET1067  SET1067 SET1067 HM218248Z/HM218210  HM218248Z/HM218210  HM220149Z/HM220110Z HM220149Z/HM220110Z SET1080 SET1076 SET1081 SET1078 SET1165 HM218248Z/HM218210 HM218248Z/HM218210	               	 20/22.5", -Ch.1103187SSS,   24"  24"  20/22.5", Ch.1103188SSS, 4248318SN-14 - <b>15</b>  20/22.5", Ch.1103188SSS, 4248318SN-14 - <b>15</b>   <b>15</b>  <b>15</b>
<b>R 142 H [6X2]</b>					
	TRAILING AXLE TRAILING AXLE		HM218248Z/HM218210 HM218248Z/HM218210	 	 <b>15</b>  <b>15</b>
<b>R 142 M [6X4]</b>					
	AD 80 AD 80 AD 80 AD 80		SET1065 SET1115 SET1065 SET1064	   	   
<b>R 142 M [6X2]</b>					
	TRAILING AXLE TRAILING AXLE		SET1081 SET1078	 	 
<b>R 143</b>					
	AM 56 AM 56 AM 56 AM 56 AM 61 AM 61 AM 70 AM 70 AM 70 AD 80 AD 80 AD 80 AD 80 AD 90 AD 90 AD 90 AD 90 AD 90 AD 90 AD 90 ADA 90	SET1163 SET1078 SET1081 SET1078 SET1081 SET1078 SET1165 SET1165 SET1165  SET1065 SET1115 SET1065 SET1064 HM218248Z/HM218210 HM218248Z/HM218210 SET1067 SET1067 SET1067 SET1067 HM218248Z/HM218210		                	                  20/22.5" <b>15</b>  20/22.5" <b>15</b>  24" <b>15</b> 178mm  24" <b>15</b> 178mm  24" <b>15</b> 203mm  24" <b>15</b> 203mm  20/22.5" <b>15</b>







											
<b>SCANIA</b>											
<b>R 143 ...</b>											
ADA 90				HM218248Z/HM218210			20/22.5		15		
ADA 90				SET1067			24"		178mm	15	
ADA 90				SET1067			24"		178mm	15	
ADA 90				SET1067			24"		203mm		
ADA 90				SET1067			24"		203mm		
AD 100				HM220149Z/HM220110Z			20/22.5				
AD 100				HM220149Z/HM220110Z			20/22.5				
AD 100				HM220149Z/HM220110Z			24"		-Ch.1180029SSS		
AD 100				HM220149Z/HM220110Z			24"		-Ch.1180029SSS		
ARA 56				SET1163							
ARA 56				SET1078							
ARA 61				SET1081							
ARA 61				SET1078							
ASA 70				SET1165							 - Ch.1161721SSS, 4292924SN
ASA 70				SET1165							 Ch.1161722, 4292925SN-37 -
TRAILING AXLE/AS 60				SET1081							
TRAILING AXLE/AS 60				SET1078							
TRAILING AXLE/ASA 80				SET1065							
TRAILING AXLE/ASA 80				SET1115							
TRAILING AXLE/AS 90				HM218248Z/HM218210							 15
TRAILING AXLE/AS 90				HM218248Z/HM218210							 15
<b>R 143 E/H/M, T 143 H</b>											
	AM 56		SET1163								
	AM 56		SET1078								
	AM 56		SET1081								
	AM 56		SET1078								
<b>T 82 H [4X2]</b>											
	AD 90			HM218248Z/HM218210							
	AD 90			HM218248Z/HM218210							
	AD 90			SET1067							 20/22.5", -Ch.1103187SSS, 4248317SN
	AD 90			SET1067							 20/22.5", -Ch.1103187SSS, 4248317SN
	AD 90			HM218248Z/HM218210							 20/22.5", Ch.1103188SSS, 4248318SN-14 - 15
	AD 90			HM218248Z/HM218210							 20/22.5", Ch.1103188SSS, 4248318SN-14 - 15
<b>T 82 H [6X2]</b>											
	AM 60		SET1081								
	AM 60		SET1078								
	AD 90			HM218248Z/HM218210							
	AD 90			HM218248Z/HM218210							
	AD 90			SET1067							 20/22.5", -Ch.1103187SSS, 4248317SN
	AD 90			SET1067							 20/22.5", -Ch.1103187SSS, 4248317SN
	AD 90			HM218248Z/HM218210							 20/22.5", Ch.1103188SSS, 4248318SN-14 - 15
	AD 90			HM218248Z/HM218210							 20/22.5", Ch.1103188SSS, 4248318SN-14 - 15
	TRAILING AXLE/AS 90			HM218248Z/HM218210							 15



# APPLICATION LISTINGS - TRUCK

A

































































































				 			
<b>SCANIA</b>							
<b>T 82 H [6X2] ...</b>							
	TRAILING AXLE/AS 90		HM218248Z/HM218210		 15		
	TRAILING AXLE/AS 90		HM218248Z/HM218210		 15		
	TRAILING AXLE/AS 90		HM218248Z/HM218210		 15		
<b>T 82 M [4X2]</b>							
	AM 55	SET1080				-Ch.1097602SSS, 4246024SN	
	AM 55	SET1076				-Ch.1097602SSS, 4246024SN	
	AM 55	SET1080				Ch.1097603SSS, 4246025SN-17 -	
	AM 55	SET1076				Ch.1097603SSS, 4246025SN-17 -	
	AM 60	SET1081					
	AM 60	SET1078					
	AD 80		SET1065				
	AD 80		SET1115				
	AD 80		SET1065				
	AD 80		SET1064				
	AD 90		HM218248Z/HM218210				
	AD 90		HM218248Z/HM218210				
	AD 90		SET1067			20/22.5", -Ch.1103187SSS, 4248317SN	
	AD 90		SET1067			20/22.5", -Ch.1103187SSS, 4248317SN	
	AD 90		HM218248Z/HM218210			20/22.5", Ch.1103188SSS, 4248318SN-14 - 15	
	AD 90		HM218248Z/HM218210			20/22.5", Ch.1103188SSS, 4248318SN-14 - 15	
<b>T 112 M [4X2]</b>							
	AM 55	SET1080				-Ch.1097602 SSS/4246024 SN	
	AM 55	SET1076				-Ch.1097602 SSS/4246024 SN	
	AM 55	SET1080				Ch.1097603 SSS/4246025 SN-17 -	
	AM 55	SET1076				Ch.1097603 SSS/4246025 SN-17 -	
	AM 55	SET1080				-Ch.1105666SSS, 4238514SN	
	AM 55	SET1076				-Ch.1105666SSS, 4238514SN	
	AM 55	SET1080				Ch.1105666SSS/4238515SN -	
	AM 55	SET1076				Ch.1105666SSS/4238515SN -	
	AD 80		SET1065				
	AD 80		SET1115				
	AD 80		SET1065				
	AD 80		SET1064				
<b>T 112 H/E</b>							
	AM 55	SET1080				-Ch.1097602 SSS/4246024 SN	
	AM 55	SET1076				-Ch.1097602 SSS/4246024 SN	
	AM 55	SET1080				Ch.1097603 SSS/4246025 SN-17 -	
	AM 55	SET1076				Ch.1097603 SSS/4246025 SN-17 -	
	AM 55	SET1080				-Ch.1105666SSS, 4238514SN	
	AM 55	SET1076				-Ch.1105666SSS, 4238514SN	
	AM 55	SET1080				Ch.1105666SSS/4238515SN -	
	AM 55	SET1076				Ch.1105666SSS/4238515SN -	
<b>T 112 [4X2, 6X2, 6X4]</b>							
	AM 60	SET1081					
	AM 60	SET1078					
	AM 70	SET1165					













				 			
<b>SCANIA</b>							
<b>T 112 [4X2, 6X2, 6X4] ...</b>							
AD 90			HM218248Z/HM218210	I		⊗ 15	
AD 90			HM218248Z/HM218210	O		⊗ 15	
AD 90/ADA 90			HM218248Z/HM218210	I		⊗ 2300mm wide ch. 15	
AD 90/ADA 90			HM218248Z/HM218210	O		⊗ 2300mm wide ch. 15	
AD 90/ADA 90			SET1067	I		⊗ 24" C	
AD 90/ADA 90			SET1067	O		⊗ 24" C	
AD 90/ADA 90			SET1067	I		⊗ 20/22" C - Ch.1103187SSS, 428317SN	
AD 90/ADA 90			SET1067	O		⊗ 20/22" C - Ch.1103187SSS, 428317SN	
AD 90/ADA 90			HM218248Z/HM218210	I		⊗ 20/22" C Ch.1033188SSS/ 4248318SN - 15	
AD 90/ADA 90			HM218248Z/HM218210	O		⊗ 20/22" C Ch.1033188SSS/ 4248318SN - 15	
AD 100			HM220149Z/HM220110Z	I			
AD 100			HM220149Z/HM220110Z	O			
<b>T 112 [6X2]</b>							
	TRAILING AXLE/AS 90		HM218248Z/HM218210	I		⊗ 15	
	TRAILING AXLE/AS 90		HM218248Z/HM218210	O		⊗ 15	
	TRAILING AXLE/AS 90		SET1067	I		⊗	
	TRAILING AXLE/AS 90		SET1067	O		⊗	
<b>T 142</b>							
	AM 55	SET1080		I		⊗ -Ch.1097602SSS, 4246024SN	
	AM 55	SET1076		O		⊗ -Ch.1097602SSS, 4246024SN	
	AM 55	SET1080		I		⊗ Ch.1097603SSS/4238514SN -	
	AM 55	SET1076		O		⊗ Ch.1097603SSS/4238514SN -	
	AM 55	SET1080		I		⊗ - Ch.1105666SSS, 4238514SN	
	AM 55	SET1076		O		⊗ - Ch.1105666SSS, 4238514SN	
	AM 55	SET1080		I		⊗ Ch.1105666SSS/4238515SN -	
	AM 55	SET1076		O		⊗ Ch.1105666SSS/4238515SN -	
<b>T 142 [4X2]</b>							
	AM 60	SET1112		I			
	AM 60	SET1078		O			
	AM 70	SET1165		I			
	AD 100		HM220149Z/HM220110Z	I			
	AD 100		HM220149Z/HM220110Z	O			
<b>T 142 [6X2]</b>							
	AM 60	SET1112		I			
	AM 60	SET1078		O			
	AM 70	SET1165		I			
	AD 100		HM220149Z/HM220110Z	I			
	AD 100		HM220149Z/HM220110Z	O			
	TRAILING AXLE/AS 90		HM218248Z/HM218210	I		15	
	TRAILING AXLE/AS 90		HM218248Z/HM218210	O		15	
<b>T 142 [6X4]</b>							
	AM 60	SET1112		I			
	AM 60	SET1078		O			
	AM 70	SET1165		I			
	AD 90/ADA 90		HM218248Z/HM218210	I		⊗ 2300mm wide ch. 15	



# APPLICATION LISTINGS - TRUCK

A













									
<b>SCANIA</b>									
<b>T 142 [6X4] ...</b>									
	AD 90/ADA 90 AD 100 AD 100			HM218248Z/HM218210 HM220149Z/HM220110Z HM220149Z/HM220110Z	  		2300mm wide ch. <b>15</b>		
<b>T 142 E</b>									
	AM 60 AM 60 AM 70	SET1112 SET1078 SET1165			  				
<b>T 142 M</b>									
	AD 80 AD 80 AD 80 AD 80 AD 90/ADA 90 AD 90/ADA 90 AD 90/ADA 90  AD 90/ADA 90  AD 90/ADA 90 4248317SN AD 90/ADA 90 4248317SN AD 90/ADA 90 AD 90/ADA 90			SET1065 SET1115 SET1065 SET1064 HM218248Z/HM218210 HM218248Z/HM218210 HM218248Z/HM218210  HM218248Z/HM218210  SET1067  SET1067  SET1067 SET1067	             	             	20/22.5", Ch.1103188SSS, 4248318SN-14 - <b>15</b> 20/22.5", Ch.1103188SSS, 4248318SN-14 - <b>15</b> 20/22.5", -Ch.1103187SSS,  20/22.5", -Ch.1103187SSS,  24"  24" 		
<b>T 143</b>									
	AM 61 AM 70 AM 70 AM 70 AD 80 AD 80 AD 80 AD 80 AD 90 AD 90 AD 90 AD 90 AD 90 AD 90 ADA 90 ADA 90 ADA 90 ADA 90 ADA 90 ADA 90 AD 100 AD 100 AD 100 AD 100 ARA 56 ARA 56	SET1112 SET1165 SET1165 SET1165		SET1065 SET1115 SET1065 SET1064 HM218248Z/HM218210 HM218248Z/HM218210  SET1067 SET1067 SET1067 SET1067 HM218248Z/HM218210 HM218248Z/HM218210 SET1067 SET1067 SET1067 SET1067 HM220149Z/HM220110Z HM220149Z/HM220110Z HM220149Z/HM220110Z HM220149Z/HM220110Z SET1163 SET1078	                   	                        	- Ch.1161721SSS, 4292924SN Ch.1161722, 4292925SN-37 -  20/22.5"  20/22.5"  24"  24"  24"  24"  20/22.5"  20/22.5"  24"  24"  24"  24"  20/22.5"  20/22.5"  24"  24"  -Ch.1180029SSS -Ch.1180029SSS		

					
<b>SCANIA</b>					
<b>T 143 ...</b>					
	ARA 61 ARA 61 ASA 70 ASA 70 TRAILING AXLE/AS 60 TRAILING AXLE/AS 60 TRAILING AXLE/ASA 80 TRAILING AXLE/ASA 80 TRAILING AXLE/AS 90 TRAILING AXLE/AS 90		SET1081 SET1078 SET1165 SET1165 SET1081 SET1078 SET1065 SET1115 HM218248Z/HM218210 HM218248Z/HM218210		 - Ch.1161721SSS, 4292924SN Ch.1161722, 4292925SN-37 -
<b>SEDDON ATKINSON</b>					
<b>201 SERIES</b>					
	1984 - 1984 - INTERNATIONAL [RA 57] INTERNATIONAL [RA 57] EATON 38 DS EATON 38 DS	SET114 HM204049/10 SET114 SET114	SET216 SET1135 SET403 SET1135 SET403 HM204049/10		-Ch.51013 -Ch.51013
<b>211 SERIES</b>					
	EATON 1800, 1&2 SPEED EATON 1800, 1&2 SPEED	SET114 SET412	SET403 SET1135		
<b>300 SERIES</b>					
	13T 13T INTERNATIONAL [RA 57] INTERNATIONAL [RA 57] EATON 38 DS EATON 38 DS	SET114 SET114	SET317 SET317 SET403 SET405 SET403 SET1135		
<b>301 SERIES</b>					
	SEDDON 110 SEDDON 110 ROCKWELL [S180E] ROCKWELL [S180E] ROCKWELL [S180E] ROCKWELL [S180E] KIRKSTALL KIRKSTALL	SET114 SET114	SET1067 SET1066 SET1068 SET1066 SET1091 SET361 SET114 HM204049/10		Ch.83772 - Ch.83772 -

































































# APPLICATION LISTINGS - TRUCK

A

					
<b>SEDDON ATKINSON</b>					
<b>311 SERIES</b>					
	EATON EATON ROCKWELL [S180] ROCKWELL [S180] INTERNATIONAL [RA 57] INTERNATIONAL [RA 57]	SET114 SET114	SET403 SET1135 SET403 SET401 SET403 SET405		
<b>400 SERIES</b>					
	SEDDON, 13T SEDDON, 13T		SET317 SET317		
<b>401 SERIES</b>					
	EATON 38 DS EATON 38 DS INTERNATIONAL [RA 57] INTERNATIONAL [RA 57] INTERNATIONAL [RA 452] INTERNATIONAL [RA 452]	SET114 SET114	SET403 SET1135 SET403 SET401 SET403 SET405		
<b>VARIOUS</b>					
	EATON 18/19 EATON 18/19 ROCKWELL [S160E/S180E] ROCKWELL [S160E/S180E]		SET403 SET1135 SET1068 SET1066		
<b>TATRA</b>					
<b>T815</b>					
	8T GAW 13T GAW 13T GAW	SET111	SET1026 SET1169		1997- 1997- 1997-
<b>VOLVO</b>					
<b>F 7 [4X2]</b>					
	FAT 6.5 FAT 6.5 FAT 6.5 FAT 6.5 FAT 6.5 FAT 6.5 FAT 6.5 FAT 6.5 FAT 6.5 FAT 6.5 FAT 6.5 FAT 6.5	6386/6320 SET212 SET1165 SET276 6386/6320 SET212 6386/6320 SET212 SET1165 SET276 SET1165 SET276	SET109		-Ch.27087 -Ch.27087 Ch.27088 - Ch.27088 - 20" Ch.27087 20" Ch.27087 22" Ch.27087 22" Ch.27087 Ch.27088 - Ch.27088 - Ch.27088 -























				 			
<b>VOLVO</b>							
<b>F 7 [4X2] ...</b>							
				SET405 SET109 SET405 SET109 SET405			 20"   20"   10  10
<b>F 7 [6X2]</b>							
	FAT 6.5 FAT 6.5 FAT 6.5 FAT 6.5 FAT 6.5 FAT 6.5 FAT 6.5 FAT 6.5 FAT 6.5 FAT 6.5 FAT 6.5 FAT 6.5 FAT 6.5 TRAILING AXLE TRAILING AXLE TRAILING AXLE TRAILING AXLE TRAILING AXLE TRAILING AXLE TRAILING AXLE TRAILING AXLE	6386/6320 SET212 SET1165 SET276 6386/6320 SET212 6386/6320 SET212 SET1165 SET276 SET1165 SET276 SET1165 SET276		SET109 SET405 SET109 SET405 SET216 SET401 SET109 SET405 SET113 SET1113 SET1165 SET276		 -Ch.27087  -Ch.27087  Ch.27088 -  Ch.27088 -  20"  -Ch.27087  20"  -Ch.27087  22"  -Ch.27087  22"  -Ch.27087  Ch.27088 -  Ch.27088 -     20"   20"   -Ch.19745  -Ch.19745  Ch.19746-  Ch.19746-   S Ride   S Ride 	
<b>F 7 [6X4, 8X2, 8X4]</b>							
	FAT 6.5 FAT 6.5 FAT 6.5 FAT 6.5 FAT 6.5 FAT 6.5 FAT 6.5 FAT 6.5 FAT 6.5 FAT 6.5 FAT 6.5	6386/6320 SET212 SET1165 SET276 6386/6320 SET212 6386/6320 SET212 SET1165 SET276 SET1165 SET276		SET109 SET405 SET109 SET405 SET109 SET405		 -Ch.27087  -Ch.27087  Ch.27088 -  Ch.27088 -  20"  -Ch.27087  20"  -Ch.27087  22"  -Ch.27087  22"  -Ch.27087  Ch.27088 -  Ch.27088 -     20"   20" 	



# APPLICATION LISTINGS - TRUCK

A







									
<b>VOLVO</b>									
<b>F 10 [6X2]</b>									
	TRAILING AXLE TRAILING AXLE TRAILING AXLE TRAILING AXLE TRAILING AXLE TRAILING AXLE TRAILING AXLE TRAILING AXLE TRAILING AXLE TRAILING AXLE TRAILING AXLE TRAILING AXLE TRAILING AXLE TRAILING AXLE TRAILING AXLE TRAILING AXLE TRAILING AXLE TRAILING AXLE TRAILING AXLE TRAILING AXLE			SET1165 SET276 HM218248Z/HM218210 SET1113 SET216 SET401 SET109 SET405 SET109 SET405 SET109 SET405 SET109 749A/742 SET113 SET1113 SET1165 SET276					
<b>F 10 [4X2, 6X2]</b>									
	RAN 71/RTN 71/RTN 72 RAN 71/RTN 71/RTN 72 RAN 81/RTN 80/RTN 87 RAN 81/RTN 80/RTN 87			SET109 SET405 SET109 749A/742 HM220149Z/HM220110Z HM218248Z/HM218210 SET1068 SET1068					
<b>F 10 [4X2, 6X2, 6X4]</b>									
	FAT 6.5 FAT 6.5 FAT 6.5 FAT 6.5 FAT 7.5 FAT 7.5	6386/6320 SET212 SET1165 SET276 SET1165 SET276		SET109 SET405					
<b>F 12 [4X2, 6X2, 6X4]</b>									
	FAT 6.5 FAT 6.5 FAT 6.5 FAT 6.5  RAN 81/RTN 80/RTN 87 RAN 81/RTN 80/RTN 87	6386/6320 SET212 SET1165 SET276		SET109 SET405 SET109 SET405 SET109 749A/742 SET1068 SET1068					-Ch.36763 -Ch.36763 Ch.36764- Ch.36764- ⊗ 20" 4 ⊗ 20" 4 ⊗ 4 ⊗ 4 ⊗ 24" 4 ⊗ 24" 4 3 3







				 			
<b>VOLVO</b>							
<b>F 12 [4X2, 6X2, 6X4, 8X2, 8X4]</b>							
	FAT 7.5 FAT 7.5 FAT 7.5 FAT 7.5 RAN 71/RTN 71/RTN 72 RAN 71/RTN 71/RTN 72	SET1165 SET276 SET1165 SET276		HM220149Z/HM220110Z HM218248Z/HM218210		-Ch.65820 -Ch.65820 ⊗ 20/21' ⊗ -Ch.65820 ⊗ 20/21' ⊗ -Ch.65820 ③ ③	
<b>F 12 [6X2]</b>							
	TRAILING AXLE TRAILING AXLE TRAILING AXLE TRAILING AXLE TRAILING AXLE TRAILING AXLE TRAILING AXLE		SET1165 SET276 HM218248Z/HM218210 SET1113 SET216 SET401 SET113 SET1113			S Ride  S Ride  Special models, Super volume Special models, Super volume ⊗ -Ch.22914 ⊗ -Ch.22914  	
<b>F 12 [6X2, 8X2]</b>							
	TRAILING AXLE TRAILING AXLE TRAILING AXLE TRAILING AXLE TRAILING AXLE TRAILING AXLE		SET109 SET405 SET109 SET405 SET109 749A/742			⊗ Ch.22915- ⊗ Ch.22915- ⊗ 20' ⊗ -Ch.27087 ⊗ 20' ⊗ -Ch.27087 ⊗ 24' ⊗ -Ch.27087 ⊗ 24' ⊗ -Ch.27087	
<b>F 16 [4X2, 6X2]</b>							
			SET109 749A/742			⊗ 24' ⊗ ④ ⊗ 24' ⊗ ④	
<b>F 16 [4X2, 6X2, 6X4]</b>							
	FAT 6.5/FAT 7.5/FAT 8.0 FAT 6.5/FAT 7.5/FAT 8.0  RTN 371/RTN 373/RAN 471 RTN 371/RTN 373/RAN 471	SET1165 SET276 SET1165 SET276		SET109 SET405 SET109 SET405 HM220149Z/HM220110Z HM218248Z/HM218210		⊗ 20/24' ⊗ 20/24'  ⊗ 20' ⊗ ④ ⊗ 20' ⊗ ④ ⊗ ④ ⊗ ④ ④ ④	
<b>F 16 [6X4]</b>							
	TRAILING AXLE TRAILING AXLE TRAILING AXLE TRAILING AXLE TRAILING AXLE TRAILING AXLE		SET109 SET405 SET109 749A/742 SET109 SET405 SET109 749A/742 SET1165 SET276			⊗ 20' ⊗ ④ ⊗ 20' ⊗ ④ ⊗ 24' ⊗ ④ ⊗ 24' ⊗ ④ ⊗ ④ ⊗ ④ ⊗ 20' ⊗ ④ ⊗ 20' ⊗ ④ ⊗ 24' ⊗ ④ ⊗ 24' ⊗ ④ ⊗ 20' ⊗ ④ ⊗ 20' ⊗ ④	



# APPLICATION LISTINGS - TRUCK

A











					
<b>VOLVO</b>					
<b>F 16 [6X4] ...</b>					
	TRAILING AXLE		SET109	I	⊗ BGT 18/21/26 Rear
	TRAILING AXLE		SET405	O	⊗ BGT 18/21/26 Rear
	TRAILING AXLE		SET1165	I	⊗ S-Ride, Rear Steer
	TRAILING AXLE		SET276	O	⊗ S-Ride, Rear Steer
<b>F 84/85</b>					
	FAT 5.0	SET1076		O	
	RATS 80		SET216	I	
	RATS 80		SET401	O	
	RATS 81		SET216	I	⊗ 363067
	RATS 81		SET401	O	⊗ 363067
<b>F 86/F 87</b>					
	FAT 5.0	SET1076		O	57mm 
	FAT 6.0	6386/6320		I	
	FAT 6.0	SET212		O	
	BAT 10		SET216	I	
	BAT 10		SET401	O	
	BAT 11		SET109	I	
	BAT 11		SET405	O	
<b>F 88/FB 88/G 88</b>					
	FAT 6.0	6386/6320		I	④ Ch.36634-
	FAT 6.0	SET212		O	④ Ch.36634-
	FAT 6.0		SET109	I	③
	FAT 6.0		SET405	O	③
	FAT 6.0		SET1068	I	
	FAT 6.0		SET1068	O	
<b>F 88/G 88 [6X2]</b>					
	TRAILING AXLE		SET216	I	
	TRAILING AXLE		SET401	O	
<b>F 89/G 89 [4X2, 6X2, 6X4]</b>					
		6386/6320		I	
		SET212		O	
			SET109	I	④
			SET405	O	④
<b>F 89/G 89 [4X2, 6X2]</b>					
			SET1068	I	③
			SET1068	O	③
<b>F 89/G 89 [6X2]</b>					
	TRAILING AXLE		SET216	I	-Ch.6997
	TRAILING AXLE		SET401	O	-Ch.6997
	TRAILING AXLE		SET216	I	⊗ Ch.6998-
	TRAILING AXLE		SET401	O	⊗ Ch.6998-
	TRAILING AXLE		SET109	I	⊗ Ch.6998 -
	TRAILING AXLE		SET405	O	⊗ Ch.6998 -













											
<b>VOLVO</b>											
<b>F 406/407/408</b>											
			SET1058 32206 32210 32207		SET1088 SET1087 SET1088 SET1087			I O I O I O I O	14 14 13 13	-Ch.7050 -Ch.7050 Ch.7051 - Ch.7051 -	
<b>F 607/608/609/610</b>											
			32210 32207		SET1089 33013 SET1089 33013			I O I O I O		-Ch.23510 -Ch.23510 Ch.23511 - Ch.23511 -	
<b>F 611</b>											
			SET1060 32208 SET1176 32208					I O I O		-Ch.2376 -Ch.2376 Ch.2377 - Ch.2377 -	
<b>F 612/613</b>											
			SET1060 32208 SET1176 32208					I O I O		-Ch.6450 -Ch.6450 Ch.6451 - Ch.6451 -	
<b>F 614</b>											
			SET1060 32208 I 32208	Ch.704 -				I O O		-Ch.703 -Ch.703 Ch.704 -	
<b>F 611/612/613/614</b>											
					SET1090 SET1089 SET1090 SET1089			I O I O		-Ch.21671 -Ch.21671 Ch.21672 - Ch.21672 -	
<b>F 615/616/617</b>											
	FAT 6.5 FAT 6.5  BAT 10.9 BAT 10.9		HM212044/HM212011 SET315 6386/6320 SET212 SET1165 SET276		SET216 SET401 SET216 SET401 SET216 SET401			I O I O I O I O I O I O		-Ch.3145 -Ch.3145 Ch.3146 - Ch.3146 - Ch.6872 - Ch.6872 - -Ch.2728 -Ch.2728 Ch.2729-Ch.6871 Ch.2729-Ch.6871 Ch.6872 - Ch.6872 -	



# APPLICATION LISTINGS - TRUCK

A







									
<b>VOLVO</b>									
<b>FB 86</b>									
	FAT 6.0 FAT 6.0 BAT 11 BAT 11 TRAILING AXLE TRAILING AXLE TRAILING AXLE TRAILING AXLE TRAILING AXLE TRAILING AXLE	6386/6320 SET212	SET109 SET405 SET216 SET401 SET216 SET401 SET109 SET405		-Ch. 20653 -Ch. 20653 ⊙ Ch.20654 - ⊙ Ch.20654 - ⊙ Ch.20654 - ⊙ Ch.20654 -				
<b>FH 12</b>									
	TRAILING AXLE TRAILING AXLE	SET1165 SET276 SET1165 SET276	SET109 SET405		⊙ 20/24" ⊙ 20/24" ⊙ ⊙ ⊙				
<b>FH 12 [4X2, 6X2, 6X4]</b>									
	CTN 372 CTN 372 RAN 471 RAN 471 TRAILING AXLE TRAILING AXLE TRAILING AXLE TRAILING AXLE TRAILING AXLE TRAILING AXLE		SET109 SET405 HM220149Z/HM220110Z HM218248Z/HM218210 HM220149Z/HM220110Z HM218248Z/HM218210 SET1165  SET276  SET109  SET405  SET109 SET405		⊙ 10 ⊙ 10 -2-3 -2-3 3 3 ⊙ 7 -Ch.A276505, -B190637 - 563621 ⊙ 7 -Ch.A276505, -B190637 - 563621 ⊙ 5 -Ch.A276505, -B190637 - 563621 ⊙ 5 -Ch.A276505, -B190637 - 563621 ⊙ ⊙				
<b>FH 12 [4X2, 6X2, 6X4, 8X4]</b>									
			SET109 SET405		⊙ ⊙				
<b>FH 16</b>									
	TRAILING AXLE TRAILING AXLE	SET1165 SET276 SET1165 SET276 SET1165 SET276	SET1165 SET276 SET109 SET405		⊙ 20/24" ⊙ 20/24" ⊙ ⊙ ⊙ 335mm bolts circle dia. ⊙ 335mm bolts circle dia. ⊙ 7 Ch.291152- ⊙ 7 Ch.291152- ⊙ 7 -Ch.291151 ⊙ 7 -Ch.291151				

				 			
<b>VOLVO</b>							
<b>FH 16 [4X2, 6X2, 6X4, 8X4]</b>							
			SET109 SET405 SET109 SET405		-Ch. A276505, -B190637 -563621 -Ch. A276505, -B190637 -563621 ⊗ ⊗		
<b>FH 16 [4X2, 6X2, 6X4]</b>							
	CTN 372 CTN 372 RAN 471 RAN 471 TRAILING AXLE  TRAILING AXLE  TRAILING AXLE  TRAILING AXLE TRAILING AXLE		SET109 SET405 HM220149Z/HM220110Z HM218248Z/HM218210 HM220149Z/HM220110Z HM218248Z/HM218210 SET1165  SET276  SET109  SET405  SET109 SET405		⊗ 10 -Ch.A291151 ⊗ 10 -Ch.A291151 2-3 2-3 3 3 ⊗ 7 -Ch.A276505, -B190637 -563621 ⊗ 7 -Ch.A276505, -B190637 -563621 ⊗ 5 -Ch.A276505, -B190637 -563621 ⊗ 5 -Ch.A276505, -B190637 -563621 ⊗ ⊗		
<b>FL 6 / FL 608-FL 612</b>							
	FAT 4.1 FAT 4.1 FAT 4.7 FAT 4.7	EK50044 SET1107 SET1108 SET1108	SET1128 SET408		Ch.B166080- Ch.B166080-  Ch.B170986- ⊗ 6774825, FAT 4.7 ⊗ 6774825, FAT 4.7		
<b>FL 6 / FL 612-FL 615</b>							
	FAT 5.0/FAT 5.6	SET1108	EK50005 SET1101		ABS ABS Ch.B166080- FAT 5.0. Ch.B166080 FAT 5.0. Ch.B166080		
<b>FL 6 / FL 616-FL 626</b>							
		SET1165 SET276 SET1165 SET276 SET1165  SET276  SET1165 SET276 SET1165 SET276			Ch.B166080- Ch.B166080- ABS ABS Ch.B166080- ABS ABS Ch.B166080- ⊗ 335mm bolts circle dia. Ch.B166080- ⊗ 335mm bolts circle dia. Ch.B166080- ⊗ 20° -Ch.B169139 ⊗ 20° -Ch.B169139 ⊗ Ch.B169140- ⊗ Ch.B169140-		
<b>FL6 [4X2, 6X2, 6X4]</b>							
			SET109 SET405		Ch.B169140 - B 190331 Ch.B169140 - B 190331		





















































# APPLICATION LISTINGS - TRUCK

A

					
<b>VOLVO</b>					
<b>FL 6 / FL 618-FL 619</b>					
	BAT 10.9/BAT 11.2/BAT 13.0		SET216	I	⊙ 335mm bolts circle dia. Ch.B166080 - B169139
	BAT 10.9/BAT 11.2/BAT 13.0		SET401	O	⊙ 335mm bolts circle dia. Ch.B166080 - B169139
<b>FL 6 / FL 616-FL 617</b>					
			SET216	I	⊙ 335mm bolts circle dia. <del>ABS</del> Ch.B166080-
			SET401	O	⊙ 335mm bolts circle dia. <del>ABS</del> Ch.B166080-
<b>FL6 / FL 616-626 [4X2]</b>					
			SET216	I	⊙ Ch.B166080-
			SET401	O	⊙ Ch.B166080-
			SET216	I	⊙ 335mm bolts circle dia. <del>ABS</del>
			SET401	O	-Ch.B169139 ⊙ 335mm bolts circle dia. <del>ABS</del> -Ch.B169139
<b>FL6</b>					
	TRAILING AXLE		SET1108	O	WTT - D275, Ch.B166080-
<b>FL 608-612</b>					
	FAT 4.1	EK50044		I	<del>ABS</del> <del>ABS</del>
	FAT 4.1	SET1107		O	<del>ABS</del> <del>ABS</del>
	FAT 4.7	EK50044		I	
	FAT 4.7	SET1107		O	
			SET1128	I	⊙ 6774825, 6795528
			SET408	O	⊙ 6774825, 6795528
<b>FL 608-611</b>					
			SET1128	I	<del>SRI</del>
			SET408	O	<del>SRI</del>
<b>FL 608-615</b>					
			SET1108	O	S 60945, S60990, S60993, S61208, S61230
<b>FL 612</b>					
	FAT 4.1	EK50044		I	S 60677, S 60936
	FAT 4.1	SET1107		O	S 60677, S 60936
	FAT 4.7	EK50044		I	S 60677, S 60936
	FAT 4.7	SET1107		O	S 60677, S 60936
<b>FL 612-614</b>					
	FAT 5.0/FAT 5.6	SET1108		O	<del>ABS</del> <del>ABS</del>
			EK50005	I	<del>ABS</del> <del>ABS</del>
			SET1101	O	<del>ABS</del> <del>ABS</del>
			SET1090	I	<del>ABS</del> <del>ABS</del>
			SET1101	O	Vehicle with fixed construction
			EK50005	I	Vehicle with fixed construction
			SET1089	O	Vehicle without fixed construction
				I	Vehicle without fixed construction





















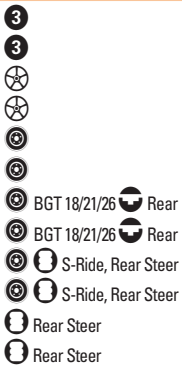













					
<b>VOLVO</b>					
<b>FL 612-615</b>					
	FAT 5.0/FAT 5.6	SET1108		 	
<b>FL 616-617</b>					
		SET1165 SET276	SET216 SET401		
<b>FL 616-619</b>					
	TRAILING AXLE TRAILING AXLE	SET1165 SET276 SET1165 SET276	SET216 SET401 SET216 SET401 SET1165 SET276		 335mm bolts circle dia.  335mm bolts circle dia.  20"  20"  335mm bolts circle dia.  335mm bolts circle dia.  20"  20"
<b>FL 618-619</b>					
	BAT 10.9/BAT 11.2 BAT 10.9/BAT 11.2 BAT 10.9/BAT 11.2 BAT 10.9/BAT 11.2 BAT 11.5 BAT 11.5 BAT 11.5/BAT 13.0  BAT 11.5/BAT 13.0  BAT 11.5/BAT 13.0 BAT 11.5/BAT 13.0		SET216 SET401 SET216 SET401 SET216 SET401 SET109  SET405  SET109 SET405		 335mm bolts circle dia.  335mm bolts circle dia.  335mm bolts circle dia.  335mm bolts circle dia.  335mm bolts circle dia.   335mm bolts circle dia.   335mm bolts circle dia.  BAT, 11.5   335mm bolts circle dia.  BAT, 11.5  6x2 TAG [HENDRICKSON] 6x2 TAG [HENDRICKSON]
<b>FL 7</b>					
	TRAILING AXLE TRAILING AXLE TRAILING AXLE TRAILING AXLE	SET1165 SET276 SET1165 SET276 SET109 SET405	SET109 SET405 SET1165 SET276		   Earlier Models  Earlier Models  Earlier Models  Earlier Models  BGT 18/21/26  Rear  BGT 18/21/26  Rear  7  7
<b>FL 7 [8X2, 8X4]</b>					
	RAEV 85B/CTEV 87 RAEV 85B/CTEV 87 RAEV 85B/CTEV 87 RAEV 85B/CTEV 87		SET109 SET405 SET109 SET405		  



# APPLICATION LISTINGS - TRUCK

A

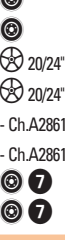
					
<b>VOLVO</b>					
<b>FL 7 [4X2, 6X2, 6X4]</b>					
	RAEV 85B/CTEV 87 RAEV 85B/CTEV 87 RAEV 85B/CTEV 87 RAEV 85B/CTEV 87 RAN 371/RTN 371/RTN 372 RAN 371/RTN 371/RTN 372 TRAILING AXLE TRAILING AXLE TRAILING AXLE TRAILING AXLE TRAILING AXLE TRAILING AXLE TRAILING AXLE TRAILING AXLE TRAILING AXLE TRAILING AXLE		SET109 SET405 SET109 SET405 HM220149Z/HM220110Z HM218248Z/HM218210 SET109 SET405 SET109 SET405 SET109 SET405 SET1165 SET276 SET1165 SET276		 BGT 18/21/26 Rear BGT 18/21/26 Rear S-Ride, Rear Steer S-Ride, Rear Steer Rear Steer Rear Steer
<b>FL 10 [6X4, 8X4]</b>					
		SET1117 SET1112			
<b>FL 10 [4X2, 6X2, 6X4, 8X4]</b>					
			SET109 SET405		
<b>FL 10 [4X2, 6X2, 6X4]</b>					
	RAN 371/RTN 371/RTN 372 RAN 371/RTN 371/RTN 372 TRAILING AXLE TRAILING AXLE TRAILING AXLE TRAILING AXLE TRAILING AXLE TRAILING AXLE TRAILING AXLE TRAILING AXLE TRAILING AXLE TRAILING AXLE		HM220149Z/HM220110Z HM218248Z/HM218210 SET109 SET405 SET109 SET405 SET109 SET405 SET1165 SET276 SET1165 SET276		 BGT 18/21/26 Rear BGT 18/21/26 Rear S-Ride, Rear Steer S-Ride, Rear Steer Rear Steer Rear Steer
<b>FL 10 [4X2, 6X2, 8X2, 6X4, 8X4]</b>					
	RAEV 85 B/CTEV 87 RAEV 85 B/CTEV 87 RAEV 85 B/CTEV 87 RAEV 85 B/CTEV 87		SET109 SET405 SET109 SET405		
<b>FL 12</b>					
		SET1165 SET276			
<b>FL 12 [4X2, 6X2, 6X4, 8X4]</b>					
			SET109 SET405 SET109 SET405		







































































					
<b>VOLVO</b>					
<b>FL 12 [4X2, 6X2, 6X4, 8X4] ...</b>					
	TRAILING AXLE TRAILING AXLE TRAILING AXLE TRAILING AXLE TRAILING AXLE TRAILING AXLE TRAILING AXLE TRAILING AXLE		SET1165 SET276 SET109 SET405 SET109 SET405 SET1165 SET276		
<b>FM 7</b>					
	RAN 371/CTN 372 RAN 371/CTN 372 TRAILING AXLE TRAILING AXLE	SET1165 SET276 SET1165 SET276	HM220149Z/HM220110Z HM218248Z/HM218210 SET1165 SET276		
<b>FM 9</b>					
	RAN 371/CTN 372 RAN 371/CTN 372 TRAILING AXLE TRAILING AXLE	SET1165 SET276	HM220149Z/HM220110Z HM218248Z/HM218210 SET1165 SET276		
<b>FM 10</b>					
	RAN 371/CTN 372/CTN 472 RAN 371/CTN 372/CTN 472 TRAILING AXLE TRAILING AXLE	SET1165 SET276 SET1165 SET276	HM220149Z/HM220110Z HM218248Z/HM218210 SET1165 SET276		
<b>FM 12</b>					
	RAN 371/CTN 372/CTN 472 RAN 371/CTN 372/CTN 472 TRAILING AXLE TRAILING AXLE	SET1165 SET276 SET1165 SET276	HM220149Z/HM220110Z HM218248Z/HM218210 SET1165 SET276		 <p>- Ch.A286102, B207062, D120498                      - Ch.A286102, B207062, D120498</p>
<b>FS 7</b>					
		SET1165 SET276	SET216 SET401 SET216 SET401		 <p>BAT 10.0/10.9/11.2                      BAT 10.0/10.9/11.2</p>































































































# APPLICATION LISTINGS - TRUCK



A











































0						 					
<b>VOLVO</b>											
<b>FS 7 ...</b>											
						SET109				BAT 11.5/13.00, BLF-B	
						SET405				BAT 11.5/13.00, BLF-B	
						SET109					
						SET405					
						SET216				BAT 11.5, LUF-B	
						SET401				BAT 11.5, LUF-B	
						SET1165					
						SET276					
		TRAILING AXLE									
		TRAILING AXLE									
<b>FS 10</b>											
						SET1165					20°
						SET276					20°
<b>FS 10 [4X2, 6X4, 8X4]</b>											
						SET109					20°
						SET405					20°
						HM220149Z/HM220110Z				Construction vehicle	
						HM218248Z/HM218210				Construction vehicle	
<b>N 7 [6X2]</b>											
		TRAILING AXLE				SET109					
		TRAILING AXLE				SET405					
		TRAILING AXLE				SET216					-Ch.11549
		TRAILING AXLE				SET401					-Ch.11549
		TRAILING AXLE				SET109					Ch.11550 -
		TRAILING AXLE				SET405					Ch.11550 -
<b>N 7 [4X2, 6X2]</b>											
		BAT 1.0				SET216					
		BAT 1.0				SET401					
		RAEV 85 B				SET109				Ch.12001 -	
		RAEV 85 B				SET405				Ch.12001 -	
<b>N 7 [4X2, 6X2, 6X4]</b>											
		FAT 5.0				SET1076					20°
		FAT 5.0				SET1076				-Ch.12099	
		FAT 6.5				6386/6320				-Ch.12099	
		FAT 6.5				SET212				Ch.12100 -	
		FAT 6.5				SET1165				Ch.12100 -	
		FAT 6.5				SET276					
		FAT 7.5				SET1165					
		FAT 7.5				SET276					
		BAT 1.3									
		BAT 1.3				SET109					
						SET405					
<b>N 10 [6X2]</b>											
		TRAILING AXLE				SET109					20°
		TRAILING AXLE				SET405					20°
		TRAILING AXLE				SET216					- Ch.46315
		TRAILING AXLE				SET401					- Ch.46315
		TRAILING AXLE				SET109					- Ch.46315
		TRAILING AXLE				SET405					- Ch.46315
		TRAILING AXLE				SET109					24° Ch.49001-
		TRAILING AXLE				749A/742					24° Ch.49001-































































































				 			
<b>VOLVO</b>							
<b>N 10 [4X2, 6X2]</b>							
	BAT 1.0 BAT 1.0		SET216 SET401	 	 		
<b>N 10 [4X2, 6X2, 6X4]</b>							
	FAT 5.0 FAT 6.5 FAT 6.5 FAT 6.5 FAT 6.5 FAT 7.5 FAT 7.5      BAT 1.3 BAT 1.3   RAN 71/RTN 71/RTN 72 RAN 71/RTN 71/RTN 72 RAN 81/RTN 80/RTN 82/RTN 87 RAN 81/RTN 80/RTN 82/RTN 87	SET1076 6386/6320 SET212 SET1165 SET276 SET1165 SET276 SET1165  SET276  SET1165 SET276	SET109 SET405 SET109 SET405 SET109 749A/742 SET109  SET405  HM220149Z/HM220110Z HM218248Z/HM218210 SET1068 SET1068	                      	-Ch.52439 -Ch.52439 Ch.52440- Ch.52440-   35mm bolts circle dia. Ch.306000-  35mm bolts circle dia. Ch.306000-  20/24"  Ch.30600-  20/24"  Ch.30600-    20"  4  20"  4  24"  4  24"  4  335mm bolts circle dia. Ch.306000-  335mm bolts circle dia. Ch.306000-  3  3  3  3		
<b>N 12 [6X2]</b>							
	TRAILING AXLE TRAILING AXLE TRAILING AXLE TRAILING AXLE TRAILING AXLE TRAILING AXLE TRAILING AXLE TRAILING AXLE TRAILING AXLE TRAILING AXLE		SET216 SET401 SET109 SET405 SET109 SET405 SET109 SET405 SET109 749A/742	         	 -Ch.8779  -Ch.8779  Ch.8780-  Ch.8780-  20"  -Ch.12000  20"  -Ch.12000  20"  -Ch.12001  20"  -Ch.12001  24"  -Ch.12001  24"  -Ch.12001		
<b>N 12 [4X2, 6X2, 6X4]</b>							
	FAT 5.0 FAT 6.5 FAT 6.5 FAT 6.5 FAT 6.5 FAT 7.5/FAT 8.0 FAT 7.5/FAT 8.0	SET1076 6386/6320 SET212 SET1165 SET276 SET1165 SET276	SET109 749A/742	       	-Ch.15169 -Ch.15169 Ch.15170 - Ch.15170 -  24"   24" 		



# APPLICATION LISTINGS - TRUCK

A

				 			
<b>VOLVO</b>							
<b>N 12 [4X2, 6X2, 6X4] ...</b>							
	BAT 1.0 BAT 1.0 BAT 1.3 BAT 1.3 RAN 71/RTN 71/RTN 72 RAN 71/RTN 71/RTN 72 RAN 81/RTN 80/RTN 82/RTN 87 RAN 81/RTN 80/RTN 82/RTN 87		SET109 SET405 SET216 SET401 SET109 SET405 HM220149Z/HM220110Z HM218248Z/HM218210 SET1068 SET1068	I O I O I O I O I O I O	 20'  4  20'  4            		
<b>N 84</b>							
	RAEV 60/RATS 60 RAEV 60/RATS 60 RATS 80 RATS 80 RATS 81 RATS 81		582/572 42687/42620 SET216 SET401 SET216 SET401	I O I O I O	 363067  363067		
<b>N 86</b>							
	FAT 5.0 FAT 6.0 FAT 6.0 BAT 10 BAT 10 BAT 11 BAT 11 BAT 11 BAT 11 TRAILING AXLE TRAILING AXLE	SET1076 6386/6320 SET212	SET216 SET401 SET109 SET405 SET109 SET405 SET216 SET401	I O I O I O I O I O	57mm    -Ch.1503875   -Ch.1503875  Ch.1503876-  Ch.1503876-		
<b>N 88 [4X2] / NB 88 [6X2]</b>							
	FAT 5.0 FAT 6.0 FAT 6.0	SET1076 6386/6320 SET212		I O I O	57mm 		
<b>N 88 / NB 88</b>							
			SET109 SET405 SET1068 SET1068	I O I O	 4  4  3  3		
<b>NB 86</b>							
	FAT 5.0 FAT 6.0 FAT 6.0 BAT 11 BAT 11 BAT 11 BAT 11	SET1076 6386/6320 SET212	SET109 SET405 SET109 SET405	I O I O I O	57mm    -Ch.1503875   -Ch.1503875  Ch.1503876-  Ch.1503876-		

				 			
<b>VOLVO</b>							
<b>NB 88 [6X2]</b>							
	TRAILING AXLE TRAILING AXLE TRAILING AXLE TRAILING AXLE		SET216 SET401 SET109 SET405	   	   		
<b>NH 12</b>							
	CTN 372/RAN 471 CTN 372/RAN 471	SET1165 SET276	HM220149Z/HM220110Z HM218248Z/HM218210	   	 24"  20" Ch.668771-  24"  20" Ch.668771-		
<b>NL 10 S</b>							
	FAT 6.5/FAT 6.7 FAT 6.5/FAT 6.7 FAT 7.5/FAT 8.0 FAT 7.5/FAT 8.0 FAT 9.0 FAT 9.0	SET1165 SET276 SET1165 SET276 SET1117 SET1112		     	   20/22.5/24"  20/22.5/24" Construction Vehicle Construction Vehicle		
<b>NL 10 S [4X2, 6X2, 6X4]</b>							
	TRAILING AXLE TRAILING AXLE TRAILING AXLE TRAILING AXLE TRAILING AXLE TRAILING AXLE		SET109 SET405 SET109 SET405 SET109 749A/742 SET109 SET405 SET109 SET405 SET109 749A/742	           	   20"  4  20"  4  24"  4  24"  4    20"  20"  24"  24"		
<b>NL 12 S</b>							
	FAT 6.5/FAT 6.7 FAT 6.5/FAT 6.7 FAT 7.5/FAT 8.0 FAT 7.5/FAT 8.0	SET1165 SET276 SET1165 SET276		   	   20/22.5/24"  20/22.5/24"		
<b>NL 12 S [4X2, 6X2, 6X4]</b>							
	RTN 371/RTN 372/RAN 371 RTN 371/RTN 372/RAN 371 TRAILING AXLE TRAILING AXLE TRAILING AXLE TRAILING AXLE TRAILING AXLE TRAILING AXLE		SET109 SET405 SET109 749A/742 SET109 SET405 HM220149Z/HM220110Z HM218248Z/HM218210 SET109 SET405 SET109 SET405 SET109 749A/742	           	 20"  4  20"  4  24"  4  24"  4    20"  20"  24"  24"		







# APPLICATION LISTINGS - TRAILER







A



# APPLICATION LISTINGS - TRAILER













							
		<b>I</b>		<b>O</b>			
<b>ARVINMERITOR [ROR]</b>							
<b>TE 9000</b>							
		EK50045	EK50046			9T	
<b>TE 9300</b>							
		EK50045	EK50046			9.3T	
<b>TM 22000</b>							
		SET414	SET1113			22T	
<b>TM 22500</b>							
		SET414	SET1113			22.5T	
<b>TM 250000</b>							
		SET414	SET1113			25T	
<b>TM 33000</b>							
		SET1069	SET1067			33T	
<b>LM 9000</b>							
		SET1254	SET1254			9T	
<b>BPW</b>							
<b>H SERIES</b>							
	1982-	SET1102	SET1079			6-6.5T	
	1982-	SET1102	SET1079			8-9T	
	1982-	SET1104	SET1113			10-12T	
	1983-	SET1068	SET1115			13-14T	
	1983-	32222	SET1083			16-18T	
	1983-	SET1071	SET1084			20T	
<b>H SERIES ECO/ECO MAXX</b>							
	1991-	SET1102	SET1079			6.5T	
	1991-	SET1102	SET1079			8-9T	
	1991-	SET1104	SET1113			10-12T	
	1994-	SET1068	SET1115			13T	
<b>H SERIES ECOPLUS</b>							
	2000-	SET1104	SET1113			8-12T	
<b>KH SERIES</b>							
	1988-	SET1102	SET1079			6-6.5T	
	1988-	SET1102	SET1079			8-9T	
	1988-	SET1104	SET1113			10-12T	
<b>KH SERIES ECO/ECO MAXX</b>							
	1991-	SET1102	SET1079			6.5T	
	1991-	SET1102	SET1079			8-9T	
	1991-	SET1104	SET1113			10-12T	
<b>KH SERIES ECOPLUS</b>							
	2000-	SET1104	SET1113			8-12T	



# APPLICATION LISTINGS - TRAILER

A

 			 <b>I</b>	<b>O</b>	
<b>BPW</b>					
<b>KR SERIES</b>					
	1985-	SET1115	SET1079	6.4T	
	1985-	SET1102	SET1079	6-6.5T	
	1985-	SET1102	SET1079	8-9T	
	1985-	SET1104	SET1113	10-12T	
	1983-	SET1068	SET1115	13-14T	
<b>KR SERIES ECO/ECO MAXX</b>					
	1991-	SET1102	SET1079	6.5T	
	1991-	SET1102	SET1079	8-9T	
	1991-	SET1104	SET1113	10-12T	
<b>KRBM 6408</b>					
	1985-	SET1115	SET1079		
<b>NH SERIES</b>					
	1993-	SET1102	SET1079	6-6.5T	
	1993-	SET1102	SET1079	8-9T	
	1993-	SET1104	SET1113	10-12T	
<b>NH SERIES ECO/ECO MAXX</b>					
	1991-	SET1102	SET1079	6.5T	
	1991-	SET1102	SET1079	8-9T	
	1991-	SET1104	SET1113	10-12T	
<b>NH SERIES ECOPLUS</b>					
	2000-	SET1104	SET1113	8-12T	
<b>NR SERIES</b>					
	1982-	SET1102	SET1079	6-6.5T	
	1982-	SET1102	SET1079	8-9T	
	1982-	SET1104	SET1113	10-12T	
	1983-	SET1068	SET1115	13-14T	
<b>NR SERIES ECO/ECO MAXX</b>					
	1991-	SET1102	SET1079	6.5T	
	1991-	SET1102	SET1079	8-9T	
	1991-	SET1104	SET1113	10-12T	
<b>R SERIES</b>					
	1982-	SET1102	SET1079	6-6.5T	
	1982-	SET1102	SET1079	8-9T	
	1982-	SET1104	SET1113	10-12T	
<b>R SERIES ECO/ECO MAXX</b>					
	1991-	SET1102	SET1079	6.5T	
	1991-	SET1102	SET1079	8-9T	
	1991-	SET1104	SET1113	10-12T	
<b>SH SERIES ECOPLUS</b>					
	2000-	SET1104	SET1113	8-12T	
<b>SKH SERIES ECOPLUS</b>					
	2000-	SET1104	SET1113	8-12T	





							
		<b>I</b>		<b>O</b>			
<b>FRUEHAUF</b>							
<b>PROPAR [P SERIES]</b>							
			SET415	SET415			9T
<b>SMB OA / VA</b>							
			SET1299	SET1299			9T
<b>GIGANT [SAE]</b>							
<b>DH 4 05506 3334</b>							
	1999		SET1061	SET1108			5.5T
<b>DH 5/6 09010 3745</b>							
	1999		SET1102	SET1079			
<b>DH 5/6 09010 4345</b>							
	1998		SET1102	SET1079			
<b>DH 6 10010 4345</b>							
			SET1104	SET1113			10T
<b>DH 6 10008 3745</b>							
			SET1104	SET1113			10T
<b>GH 4 05506 3010</b>							
	1999		SET1061	SET1108			5.5T
<b>GNV 5 10010 3020</b>							
	12/96		SET1104	SET1113			
<b>GNV 5 12010 3620</b>							
	1996		SET1104	SET1113			
<b>GNVH 5 100010 3020</b>							
	1997		SET1104	SET1113			Protec axle
<b>GNVH 5 100010 3620</b>							
	1997		SET1104	SET1113			Protec axle
<b>GNVH 5 12010 3020</b>							
	1997		SET1104	SET1113			Protec axle
<b>GNVH 5 12010 3620</b>							
	1997		SET1104	SET1113			Protec axle
<b>GNVH 5 12010 4220</b>							
	1999		SET1104	SET1113			
<b>GNVH 5/6 09010 4218</b>							
	1997		SET1102	SET1079			Protec Axle
<b>GV 2001 10510 3020</b>							
			SET1102	SET1102			Protec axle







# APPLICATION LISTINGS - TRAILER

A



 			 <b>I</b>	<b>O</b>	
<b>GIGANT [SAE]</b>					
<b>GV 2001 12010 3020</b>					
			SET1104	SET1102	
<b>GVH 5 10008 3620</b>					
	1997		SET1104	SET1113	
<b>GVH 5 10010 3020</b>					
	1997		SET1104	SET1113	
<b>GVH 5 10010 3620</b>					
	1997		SET1104	SET1113	
<b>GVH 5 10010 4220</b>					
	1997		SET1104	SET1113	
<b>GVH 5 12010 3020</b>					
	1997		SET1104	SET1113	
<b>GVH 5 12010 3620</b>					
	1997		SET1104	SET1113	
<b>GVH 5 12010 4220</b>					
	1996		SET1104	SET1113	
<b>GZV 5 12010 4220</b>					
	1999		SET1104	SET1113	Protec axle
<b>SH 3 10510 3020</b>					
			SET1065	SET1065	
<b>SNH 3 10510 3020</b>					
			SET1065	SET1065	
<b>SV 2 14010 4220 [340120]</b>					
			SET1069	SET1067	
<b>SV 2 06706 3015</b>					
	1990		SET1063	SET1061	
<b>SV 2 20010 4220</b>					
	1998			SET1069	
<b>SV 2 05506 3012</b>					
	1989		SET1061	SET1060	
<b>SV 3 10508 3520 [340022]</b>					
			SET1069	SET1067	
<b>SV 3 10510 3020</b>					
			SET1065	SET1065	
<b>SV 3 12010 3020</b>					
			SET1067	SET1065	





							
		<b>I</b>		<b>O</b>			
<b>GIGANT [SAE]</b>							
SV 3 13010 3520 [340250]							
		SET1067		SET1065			
5120 / S 32							
		32210		32208			
5122 / S 33							
		SET1063		SET1061			
5203 / S 44							
		SET1065		SET1063			
5204 / S 44							
		SET1067		SET1065			
5205 / S 44							
		SET1069		SET1067			
5206 / S 44							
		33024		SET1067			
5207 / S 44							
		33024		SET1067			
7103 / S 33							
		SET1065		SET1063			
7121 / S 33							
				SET1060			
7104 / S 35							
		SET1067		SET1065			
7404 / S 33							
		SET1065		SET1065			
9164 / S 35							
		SET1067		SET1065			
9303 / S 4420							
		SET1065		SET1063			
9304 / S 4420							
		SET1067		SET1065			
9404 / S 35							
		SET1065		SET1065			
<b>KÄSSBOHRER</b>							
09-01.087							
		SET1024		SET1022		6.5T	



# APPLICATION LISTINGS - TRAILER













A



 			 <b>I</b>	<b>O</b>	
<b>KÄSSBOHRER</b>					
<b>09-01.088</b>					
			SET1024	SET1022	6.5T
<b>09-01.111</b>					
			SET1024	SET1065	9T
<b>09-01.112</b>					
			SET1024	SET1065	9T
<b>09-01.113</b>					
			SET1024	SET1065	9T
<b>09-01.114</b>					
			SET1024	SET1065	9T
<b>09-01.119</b>					
			SET1024	SET1065	9T
<b>09-01.121</b>					
			SET1024	SET1065	9T
<b>09-01.122</b>					
			SET1024	SET1065	9T
<b>09-01.030</b>					
			SET1067	SET1065	10T
<b>09-01.062</b>					
			SET1067	SET1065	10T
<b>09-01.075</b>					
			SET1067	SET1065	10T
<b>09-01.077</b>					
			SET1067	SET1065	10T
<b>09-01.089</b>					
			SET1067	SET1065	10T
<b>09-01.093</b>					
			SET1067	SET1065	10T
<b>09-01.100</b>					
			SET1067	SET1065	10T
<b>MERCEDES - BENZ DISCOS</b>					
<b>NR 5/10 DCL - 9</b>					
			SET1117	SET1080	







# APPLICATION LISTINGS - TRAILER

							
		<b>I</b>		<b>O</b>			
<b>MONTENEGRO</b>							
<b>7.5 T</b>							
		SET1066	SET1066			061001243 / A	
<b>8 T</b>							
		SET1066	SET1066			061 068/1176, 061001231	
<b>8.5 T</b>							
		SET1066	SET1066			061001271	
<b>9.5 T</b>							
		SET1066	SET1066			061001230/A, 0611025	
<b>10.5 T</b>							
		SET1066	SET1066			061001170A	
<b>11 T</b>							
		SET415	SET415			061001299	
<b>11.5 T</b>							
		SET415	SET415			061001210/B, 061001295	
<b>13 T</b>							
		SET1066	SET1066			0611103, 0611170	
<b>SAF</b>							
<b>EBN3140 - 6</b>							
		SET1111	SET1107				
<b>EBN3130 - 12</b>							
		SET1111	SET1107				
<b>EBN4040</b>							
		30311	SET1030				
<b>EBN4530</b>							
		SET1112	SET1109				
<b>EBN4535</b>							
		SET1112	SET1109				
<b>EBN4540</b>							
		SET1112	SET1109				
<b>EBN4540 - 6</b>							
		SET1112	SET1109				
<b>EBN5535</b>							
		SET1100	SET1031				







# APPLICATION LISTINGS - TRAILER

A

			
		<b>I</b>	<b>O</b>
<b>SAF</b>			
<b>ES5030</b>			
		SET1032	SET1031
<b>ESN4040</b>			
		30311	SET1030
<b>ESN4540</b>			
		SET1032	SET1031
<b>ESN5030</b>			
		SET1032	SET1031
<b>ESN5542</b>			
		SET1062	SET1031
<b>ESN6030</b>			
		SET1033	SET1031
<b>EZN5030</b>			
		SET1032	SET1031
<b>EZN6030</b>			
		SET1033	SET1031
<b>RBM8442</b>			
		SET414	SET1113
<b>RBM8442/12</b>			
		SET113	SET1113
<b>RLBM8442</b>			
		SET414	SET1113
<b>RLSM11242</b>			
		SET414	SET1113
<b>RLSM8442</b>			
		SET414	SET1113
<b>RLSM9042</b>			
		SET1085	SET1085
<b>RLSM9042/20</b>			
		SET1085	SET1085
<b>RS5030</b>			
		SET1032	SET1031
<b>RSM11242</b>			
		SET414	SET1113
<b>RSM6242/12 - 8</b>			
		SET113	SET1100

APPLICATION LISTINGS - TRAILER





							
		<b>I</b>		<b>O</b>			
<b>SAF</b>							
<b>RSM6242/12 - 10</b>							
			SET113	SET1100			
<b>RSM6542</b>							
			SET1085	SET1085			
<b>RSM8442</b>							
			SET414	SET1113			
<b>RSM8442 - 8</b>							
			SET414	SET1113			
<b>RSM9042</b>							
			SET1085	SET1085			
<b>RSM9042/20</b>							
			SET1085	SET1085			
<b>RZM11242</b>							
			SET414	SET1113			
<b>RZM8442 - 8</b>							
			SET414	SET1113			
<b>RZM13130</b>							
			SET1067	SET1081			
<b>RZM16242</b>							
			SET1070	SET1083			
<b>RZT16242</b>							
			SET1070	SET1083			
<b>WESN5030</b>							
			SET1032	SET1031			
<b>WEZN5030</b>							
			SET1032	SET1031			
<b>WESN6030</b>							
			SET1033	SET1031			
<b>WEZN6030</b>							
			SET1033	SET1031			
<b>WEZN6030 - 12</b>							
			SET1033	SET1031			
<b>WRZM11242</b>							
			SET414	SET1113			
<b>WRZM6242</b>							
			SET113	SET1100			







# APPLICATION LISTINGS - TRAILER

A







 			 <b>I</b>	<b>O</b>	
<b>SAF</b>					
<b>WRZM6242 - 8</b>					
			SET113	SET1100	
<b>WRZM8442</b>					
			SET414	SET1113	
<b>WRZM8442 - 8</b>					
			SET414	SET1113	
<b>WRLZM11030</b>					
			SET414	SET1113	
<b>WRLZM11035 - 8</b>					
			SET414	SET1113	
<b>WRLZM11035 - 10</b>					
			SET414	SET1113	
<b>WRLZM8130</b>					
			SET414	SET1113	
<b>WRLZM8435 - 8</b>					
			SET414	SET1113	
<b>WRLZM8435 - 10</b>					
			SET414	SET1113	
<b>SMB</b>					
<b>SMB OA / VA</b>					
			SET1299	SET1299	9T
<b>SCHMITZ CARGOBULL</b>					
<b>SKI [HSF9010]</b>					
			SET1113	SET1104	
<b>SKO 80/45, 80/60 [HSF9010]</b>					
			SET1079	SET1102	ID no. 013510-11
			SET1079	SET1102	ID no. 013631/014945
			SET1079	SET1102	ID no. 016951/016958
			SET1062	SET1104	ID no. 016963-64
			SET1062	SET1104	ID no. 017491-92
<b>SKO 80/45, 80/60 [HSF9010 ECO]</b>					
			SET1079	SET1102	
<b>SKO 80/45, 80/60 [HSFH9010]</b>					
			SET1079	SET1102	ID no. 015356-57
			SET1062	SET1104	ID no. 016977-78





 			 <b>I</b>	<b>O</b>	
<b>SCHMITZ CARGOBULL</b>					
<b>SKO 80/45, 80/60 [KHSF9008]</b>					
			SET1079 SET1062	SET1102 SET1104	ID no. 013806-07 ID no. 016979-80
<b>SKO 80/45, 80/60 [NR5/10DCL-9DC-C/L TYP A]</b>					
			SET1117	32311	
<b>SKO 80/45, 80/60 [NR5/10DCL-9DC-C/L TYP V]</b>					
			SET1117	32311	
<b>SKO 80/45, 80/60 [SHSF9010]</b>					
			SET1079	SET1102	
<b>SKO 80/45, 80/60 [SK500 9T U30]</b>					
			SET414	SET1113	
<b>SKO 80/45, 80/60 [SKHBF9010]</b>					
			SET1113	SET1104	
<b>SKO 80/45, 80/60 [SKHSF9008]</b>					
			SET1079	SET1102	
<b>SKO 80/45, 80/60 [SKHSF9010]</b>					
			SET1113	SET1104	
<b>SKO 80/45, 80/60 [SKRS9042 SK500 MRH-M/U]</b>					
			SET414	SET1113	
<b>SKO 80/45, 80/60 [TZ3/2C6-10.5/MRH2]</b>					
			SET1102	SET1092	
<b>SKO FP 25 [HSF9010]</b>					
			SET1079 SET1079 SET1079 SET1062 SET1062	SET1102 SET1102 SET1102 SET1104 SET1104	ID no. 013510-11 ID no. 013631/014945 ID no. 016951/016958 ID no. 016963-64 ID no. 017491-92
<b>SKO FP 25 [HSF9010 ECO]</b>					
			SET1079	SET1102	
<b>SKO FP 25 [HSFH9010]</b>					
			SET1079 SET1062	SET1102 SET1104	ID no. 015356-57 ID no. 016977-78
<b>SKO FP 25 [KHSF9008]</b>					
			SET1079 SET1062	SET1102 SET1104	ID no. 013806-07 ID no. 016979-80
<b>SKO FP 25 [NR5/10DCL-9DC-C/L TYP A]</b>					
			SET1117	32311	
<b>SKO FP 25 [NR5/10DCL-9DC-C/L TYP V]</b>					
			SET1117	32311	



# APPLICATION LISTINGS - TRAILER

A

 			 <b>I</b>	<b>O</b>	
<b>SCHMITZ CARGOBULL</b>					
<b>SKO FP 25 [SHSF9010]</b>					
			SET1079	SET1102	
<b>SKO FP 25 [SK500 9T U30]</b>					
			SET414	SET1113	
<b>SKO FP 25 [SKHBF9010]</b>					
			SET1113	SET1104	
<b>SKO FP 25 [SKHSF9008]</b>					
			SET1079	SET1102	
<b>SKO FP 25 [SKHSF9010]</b>					
			SET1113	SET1104	
<b>SKO FP 25 [SKRS9042 SK500 MRH-M/U]</b>					
			SET414	SET1113	
<b>SKO FP 25 [TZ3/2C6-10.5/MRH2]</b>					
			SET1102	SET1092	
<b>SPR/SCS [HSF9010]</b>					
			SET1079	SET1102	ID no. 013510-11
			SET1079	SET1102	ID no. 013631/014945
			SET1079	SET1102	ID no. 016951/016958
			SET1062	SET1104	ID no. 016963-64
			SET1062	SET1104	ID no. 017491-92
<b>SPR/SCS [HSF9010 ECO]</b>					
			SET1079	SET1102	
<b>SPR/SCS [HSFH9010]</b>					
			SET1079	SET1102	ID no. 015356-57
			SET1062	SET1104	ID no. 016977-78
<b>SPR/SCS [KHSF9008]</b>					
			SET1079	SET1102	ID no. 013806-07
			SET1062	SET1104	ID no. 016979-80
<b>SPR/SCS [NR5/10DCL-9DC-C/L TYP A]</b>					
			SET1117	32311	
<b>SPR/SCS [NR5/10DCL-9DC-C/L TYP V]</b>					
			SET1117	32311	
<b>SPR/SCS [SHSF9010]</b>					
			SET1079	SET1102	
<b>SPR/SCS [SK500 9T U30]</b>					
			SET414	SET1113	
<b>SPR/SCS [SKHBF9010]</b>					
			SET1113	SET1104	

				
		<b>I</b>	<b>O</b>	
<b>SCHMITZ CARGOBULL</b>				
SPR/SCS [SKHSF9008]				
		SET1079	SET1102	
SPR/SCS [SKHSF9010]				
		SET1113	SET1104	
SPR/SCS [SKRS9042 SK500 MRH-M/U]				
		SET414	SET1113	
SPR/SCS [TZ3/2C6-10.5/MRH2]				
		SET1102	SET1092	
<b>TRAILOR</b>				
<b>L200</b>	<b>L300 TM</b>	<b>L400 TEM</b>		
		JM718149A/JM718110	SET1179	
<b>YORK</b>				
<b>10 T</b>				
		SET414	SET1113	
<b>13 T</b>				
		SET414	H212749/H212710	
<b>15 T</b>				
		SET317	SET414	







# APPLICATION LISTINGS - BUS

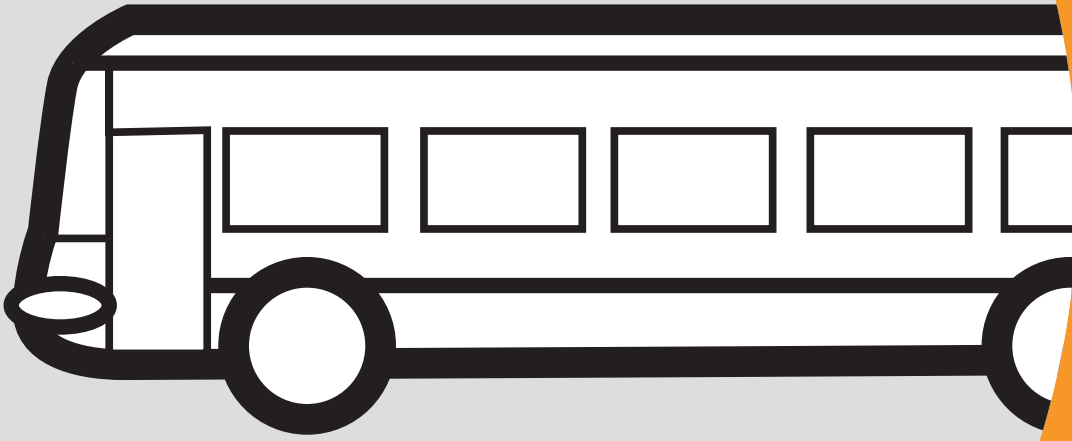







A



# APPLICATION LISTINGS - BUS



















													
<b>ALEXANDER DENNIS</b>													
<b>TRIDENT</b>													
				JXC25381CD-90UB6 JXC25381CD-90UB6 JXC25381CD-90UB6 JXC25381CD-90UB6						I O I O		O O O O	
<b>ENVIRO 500</b>													
				JXC25381CD-90UB6 JXC25381CD-90UB6						I O			
<b>BREDAMENARINIBUS</b>													
<b>VIVACITY M / C</b>													
		IPA BRA 80				SET1237				I / O			
<b>DENNIS</b>													
<b>DART</b>													
				SET1139 HM801346X/HM801310		SET105 3982/3920				I O I O			
<b>DELTA 1700</b>													
		EATON 18 SERIES EATON 18 SERIES				SET403 SET1135				I O			
<b>ELITE</b>													
		EATON 18/23 SERIES EATON 18/23 SERIES EATON DS 401 EATON DS 401				SET403 SET1135 SET403 SET1135				I O I O			
<b>MUNICIPAL 2000/2200</b>													
		EATON 18/23 SERIES EATON 18/23 SERIES				SET403 SET1135				I O			
<b>MUNICIPAL 2400</b>													
		EATON DS/401 BOGIE EATON DS/401 BOGIE				SET403 SET1135				I O			
<b>TRIDENT</b>													
		DANA D64 DANA D64				SET1242 SET1242				I O			
<b>IRISBUS</b>													
<b>CITYCLASS 491.10.29 / 491.12.29</b>													
		BRA 130 / 132				SET1257				I / O			
<b>CITELIS 10.5 / 12</b>													
		BRA 130 / 132				SET1257				I / O			





A



# APPLICATION LISTINGS - BUS

A

						
<b>IVECO</b>						
<b>315 S.8-18 / 316.8-13</b>						
		SET1031 SET1075		SET1045 SET1063		
<b>315.8-13 / 315.8-17 TURBO</b>						
		SET1031 SET1075		SET1045 SET1063		
<b>370 S.10-24 / 370 S.12-24</b>						
		6386/6320 SET1079		SET1287 SET1286		
<b>370 S.12-25L/30</b>						
		6386/6320 SET1079		SET1287 SET1286		
<b>370.10-24/25, 370.12-24/25</b>						
		6386/6320 SET1079		SET1068 SET1066		
<b>370.12-25L/30, 370.12-35</b>						
		6386/6320 SET1079		SET1068 SET1066		
<b>470.10-20 / 470.12-20</b>						
		SET1032 SET1078		SET1093 SET1117		
<b>490.18.29</b>						
		SET1152 SET1079				
<b>570.10-20 / 570.12-20</b>						
		SET1032 SET1078		SET1093 SET1117		







									
<b>IVECO</b>									
<b>670.12-20</b>									
		SET1032 SET1078		SET1093 SET1117		I O I O			
<b>2480.12</b>									
		SET1152 SET1079		SET1053 SET1026		I O I O			
<b>4480-18</b>									
		SET1152 SET1079		SET1053 SET1026		I O I O			
<b>EUROCLASS - 380.10-29</b>									
		6386/6320 SET1079		SET1287 SET1286		I O I O			
<b>EUROCLASS - 380.12-29/35</b>									
		6386/6320 SET1079		SET1287 SET1286		I O I O			
<b>EUROCLASS HD - 380.12-38</b>									
		6386/6320 SET1079		SET1287 SET1286		I O I O			
<b>EUROTECH - 370 SE-27/29/35</b>									
		6386/6320 SET1079		SET1113 SET1286		I O I O			
<b>I-EFFEUNO - 671.22-24</b>									
		SET1032 SET1078		SET1053 SET1026		I O I O			
<b>S-EFFEUNO - 571.10-20</b>									
		SET1032 SET1078		SET1053 SET1026		I O I O			





A



# APPLICATION LISTINGS - BUS

A







													
<b>IVECO</b>													
<b>S-EFFEUNO - 571.12-20</b>													
				SET1032 SET1078				SET1053 SET1026			I O I O		
<b>TURBOCITY-S - 580.10-21</b>													
				SET1152 SET1079				SET1053 SET1026			I O I O		
<b>TURBOCITY-S - 580.12-21/22</b>													
				SET1152 SET1079				SET1053 SET1026			I O I O		
<b>TURBOCITY-SR - 590E.12-22</b>													
				SET1152 SET1079				SET317 SET317			I O I O		
<b>TURBOCITY-U - 480.10-21/22</b>													
				SET1152 SET1079				SET1053 SET1026			I O I O		
<b>TURBOCITY-U - 480.12-21/22/26</b>													
				SET1152 SET1079				SET1053 SET1026			I O I O		
<b>TURBOCITY-UR - 490.10-22</b>													
				SET1152 SET1079				SET317 SET317			I O I O		
<b>TURBOCITY-UR - 490.12-22</b>													
				SET1152 SET1079				SET317 SET317			I O I O		
<b>TURBOCITY-UR - 490E.10-22</b>													
				SET1152 SET1079				SET317 SET317			I O I O		

									
<b>IVECO</b>									
<b>TURBOCITY-UR - 490E.12-22</b>									
				SET1152 SET1079		SET317 SET317	I O I O		
<b>TURBOCITY-I - 680.12-21</b>									
				SET1152 SET1079		SET1053 SET1026	I O I O		
<b>TURBOCITY-I - 3480.18-29</b>									
				SET1152 SET1079		SET1053 SET1026	I O I O		
<b>U-EFFEUNO - 471.10-20</b>									
				SET1032 SET1078		SET1053 SET1026	I O I O		
<b>U-EFFEUNO - 471.12-20</b>									
				SET1032 SET1078		SET1053 SET1026	I O I O		
<b>KÄSSBOHRER-SETRA</b>									
<b>S 309 HD</b>									
				SET1301 SET1078			I O		
<b>S 312 HD</b>									
	ZF ZF			SET1301 SET1078		SET1052 SET1051	I O I O		
<b>S 315 HD</b>									
	ZF ZF SCANIA SCANIA			SET1301 SET1078		SET1052 SET1051 SET1052 SET1051	I O I O I O		



































# APPLICATION LISTINGS - BUS

A

						
<b>MAN</b>						
<b>292 [TYPE 880]</b>						
	V7-70 SL V7-70 SL V7-75 SL V7-75 SL H07-1080 H07-1080 H09-1180 H09-1180	SET1300 SET1110 SET1300 SET1079		SET1093 SET1049 SET1093 SET1049	I O I O I O I O	
<b>292/332/362 H [TYPE 882]</b>						
	V7-70 SL V7-70 SL V7-75 SL V7-75 SL H 07-1080 H 07-1080 H 09-1180 H 09-1180	SET1300 SET1110 SET1300 SET1079		SET1093 SET1049 SET1093 SET1049	I O I O I O I O	
<b>EL 202 [TYPE A 12]</b>						
	V9-65 L V9-65 L HONL-1180 HONL-1180 HONL-1180 HONL-1180	SET1300 SET1079		SET1306 SET1049 SET1306 SET1049	I O I O I O	-11/93 -11/93 12/93 - 12/93 -
<b>EL 202 F/262 F</b>						
	V9-65 L V9-65 L	SET1300 SET1079			I O	
<b>EL 202/222/262</b>						
	V9-65 L V9-65 L	SET1300 SET1079			I O	
<b>ND 202</b>						
	V9-65 L V9-65 L	SET1300 SET1079			I O	
<b>ND 313/363 FR</b>						
	HONP-13100			SET1091	O	
<b>NG 232 CNG</b>						
	V9-65 L V9-65 L	SET1300 SET1079			I O	
<b>NG 235 F LPG</b>						
	V9-65 L V9-65 L	SET1300 SET1079			I O	
<b>NG 252/262/272/312</b>						
	V9-65 L V9-65 L	SET1300 SET1079			I O	















					
<b>MAN</b>					
<b>NG 263/313 F</b>					
	HONP-13100		SET1091		
<b>NG 312 BVG</b>					
	V9-65 L	SET1300			
	V9-65 L	SET1079			
<b>NG 312 F</b>					
	V9-65 L	SET1300			
	V9-65 L	SET1079			
<b>NG 312 SVB</b>					
	V9-65 L	SET1300			
	V9-65 L	SET1079			
<b>NGT 204 F</b>					
	V9-65 L	SET1300			
	V9-65 L	SET1079			
<b>NGT 204-M16</b>					
	V9-65 L	SET1300			
	V9-65 L	SET1079			
<b>NL 202/213/222</b>					
	V9-65 L	SET1300			
	V9-65 L	SET1079			
<b>NL 202 [TYPE 895] / F [TYPE 898]</b>					
	V9-65 L	SET1300			
	V9-65 L	SET1079			
	HONL-1180		SET1306		
	HONL-1180		SET1049		
<b>NL 205 M11 LPG</b>					
	V9-65 L	SET1300			
	V9-65 L	SET1079			
<b>NL 223/263/313 F</b>					
	HONP-13100		SET1091		
<b>NL 232 F CNG</b>					
	V9-65 L	SET1300			
	V9-65 L	SET1079			
<b>NL 240 F/250/262/313</b>					
	V9-65 L	SET1300			
	V9-65 L	SET1079			
<b>NL 262-BVG</b>					
	V9-65 L	SET1300			
	V9-65 L	SET1079			



# APPLICATION LISTINGS - BUS

A

											
<b>MAN</b>											
<b>NL 262 R</b>											
	V9-65 L	SET1300		I							
	V9-65 L	SET1079		O							
<b>NL 242 M12 F LPG</b>											
	HONP-13100		SET1091	O							
<b>NL 243 M12</b>											
	HONP-13100		SET1091	O							
<b>NL/NUE 263/313/353 F 15M</b>											
	HONP-13100		SET1091	O							
<b>NM 152 MIDI BUS [TYPE A05]</b>											
	V9-65 L	SET1300		I							
	V9-65 L	SET1079		O							
	HONM-0780		XGA32021X	I							
	HONM-0780		SET1091	O							
<b>NMT 222 M10 F</b>											
	V9-60NL	SET1109		I							
	HOY-0955		SET1024	O							
<b>RH 352/402/422 SKD, RH 353/403 F</b>											
	HOY-1175	SET1091		O							
<b>SG 242/282 H [TYPE 795]</b>											
	HNL-70 SL	SET1300		I							
	HNL-70 SL	SET1110		O							
	V7-70 SL	SET1300		I							
	V7-70 SL	SET1110		O							
	H 07-1080		SET1093	I							
	H 07-1080		SET1049	O							
	H 09-1180		SET1093	I							
	H 09-1180		SET1049	O							
<b>SG 242/292/322 [TYPE 793]</b>											
	V7-70 SL	SET1300		I							
	V7-70 SL	32210		O							
	V7-70 SL	SET1300		I							
	V7-70 SL	SET1110		O							
	V7-75 SL	SET1300		I							
	V7-75 SL	SET1079		O							
	H 07-10/11120		SET1306	I							
	H 07-10/11120		SET1049	O							
	H 07-1080		SET1306	I							
	H 07-1080		SET1049	O							
	H 07-11120		SET1306	I							-11/93
	H 07-11120		SET1049	O							-11/93
	H 07-11120		SET1306	I							12/93 -
	H 07-11120		SET1049	O							12/93 -
	H0M7-1100		SET1306	I							-11/93
	H0M7-1100		SET1049	O							-11/93
	H0M7-1100		SET1306	I							12/93 -
	H0M7-1100		SET1049	O							12/93 -







					
<b>MAN</b>					
<b>SL 200</b>					
	V7-70SL	SET1300		I	
<b>SL 202 [TYPE 791]</b>					
	V7-70 SL	SET1300		I	
	V7-70 SL	32210		I	
	V7-70 SL	SET1300		I	
	V7-70 SL	SET1110		I	
	V7-75 SL	SET1300		I	
	V7-75 SL	SET1079		I	
	H 07-1080		SET1093	I	
	H 07-1080		SET1049	I	
	H 09-1180		SET1093	I	
	H 09-1180		SET1049	I	
<b>SUE 242 [TYPE 888]</b>					
	V7-70 SL	SET1300		I	
	V7-70 SL	SET1110		I	
	V7-75 SL	SET1300		I	
	V7-75 SL	SET1079		I	
	H 07-1080		SET1093	I	
	H 07-1080		SET1049	I	
	H 09-1180		SET1093	I	
	H 09-1180		SET1049	I	
<b>SUE 240/280 [TYPE 789]</b>					
	V7-70 SL	SET1300		I	
	V7-70 SL	SET1110		I	
	H 07-1080		SET1093	I	
	H 07-1080		SET1049	I	
<b>MERCEDES-BENZ</b>					
<b>508 I</b>					
	VL 2/6-31	SET1098		I	
	VL 2/6-31	SET1074		I	
	HL 2/3-57		SET928	I	
	HL 2/3-57		SET1098	I	
	HL 4/01 D-10/47:9		SET1092	I	
	HL 4/01 D-10/47:9		SET1103	I	
<b>709</b>					
	VL 1/9 C-2.3	SET1097		I	
	VL 1/9 C-2.3	33205		I	
	VL 2/13 C-2.9	SET1098		I	
	VL 2/13 C-2.9	SET1074		I	
<b>710</b>					
	VL 1/9 C-2.3	SET1097		I	
	VL 1/9 C-2.3	33205		I	
	VL 2/13 C-2.9	SET1098		I	
	VL 2/13 C-2.9	SET1074		I	
	HL 2/17-5.9/40:11		SET1086	I	
	HL 2/17-5.9/43:10		SET1086	I	







A



# APPLICATION LISTINGS - BUS

A

									
									
<b>MERCEDES-BENZ</b>									
<b>712</b>									
	VL 1/9 C-2.3 VL 1/9 C-2.3 VL 2/13 C-2.9 VL 2/13 C-2.9	SET1097 33205 SET1098 SET1074							
<b>712 E</b>									
	VL 2/13 C-2.9 VL 2/13 C-2.9 HL 2/17-5.9/43:10	SET1098 SET1074		SET1086					
<b>1114</b>									
	VL 2/13 C-2.9 VL 2/13 C-2.9 HL2/15-5.9/40:11 HL 2/17-5.9/43:10 HL 4/35 D-78	SET1098 SET1074		SET1086 SET1086 SET401					
<b>1114 K</b>									
	VL 3/11 D-44 VL 3/11 D-44 HL 4/35 D-78	SET1113 SET1108		SET401					
<b>1114 L</b>									
	VL 3/11 D-44 VL 3/11 D-44 HL 4/30 DS-64 HL 4/35 D-78 HL 4/35 D-92	SET1113 SET1108		SET1046 SET401 SET1091					
<b>1114 S</b>									
	VL 3/11 D-44 VL 3/11 D-44	SET1113 SET1108							
<b>1117</b>									
	VL 3/11 D-44 VL 3/11 D-44 HL 4/35 D-78	SET1113 SET1108		SET401					
<b>1117 K</b>									
	VL 3/11 D-44 VL 3/11 D-44 HL 4/35 D-78	SET1113 SET1108		SET401					
<b>1117 L</b>									
	VL 3/11 D-44 VL 3/11 D-44 VL 3/12 D-53 VL 3/12 D-53 HL 4/35 D-78 HL 4/35 D-92 HL 4/05 D-9.2 HL 4/05 D-9.2	SET1113 SET1108 SET1113 SET1108		SET401 SET1091 SET1091 SET1115					







						
<b>MERCEDES-BENZ</b>						
<b>1117 L0</b>						
	VL 3/11 D-44 VL 3/11 D-44	SET1113 SET1108			I O	
<b>1117 LS</b>						
	VL 3/11 D-44 VL 3/11 D-44 HL 4/35 D-78 HL 4/35 D-92	SET1113 SET1108		SET401 SET1091	I O I I	
<b>1117 S</b>						
	VL 3/11 D-44 VL 3/11 D-44 HL 4/35 D-78 HL 4/35 D-92	SET1113 SET1108		SET401 SET1091	I O I I	
<b>1120</b>						
	VL 3/11 D-44 VL 3/11 D-44 HL 4/35 D-78	SET1113 SET1108		SET401	I O I	
<b>1120 L</b>						
	VL 3/11 D-44 VL 3/11 D-44 HL 4/35 D-78 HL 4/35 D-92 HL 4/05 D-9.2 HL 4/05 D-9.2	SET1113 SET1108		SET401 SET1091 SET1091 SET1115	I O I I I O	
<b>1120 LS</b>						
	VL 3/11 D-44 VL 3/11 D-44 HL 4/05 D-9.2 HL 4/05 D-9.2 HL 4/35 D-78 HL 4/35 D-92	SET1113 SET1108		SET1091 SET1115 SET401 SET1091	I O I O I I	
<b>1120 S</b>						
	VL 3/11 D-44 VL 3/11 D-44 HL 4/35 D-78 HL 4/35 D-92	SET1113 SET1108		SET401 SET1091	I O I I	
<b>1121 L</b>						
	VL 2/11 D-3.8 VL 3/11 D-44 VL 3/11 D-44 HL 4/29 D-92 HL 4/35 D-78 HL 4/35 D-92	SET1111 SET1113 SET1108		SET1103 SET401 SET1091	I I O I I I	
<b>1314</b>						
	VL 3/11 D-44 VL 3/11 D-44	SET1113 SET1108			I O	



















A



# APPLICATION LISTINGS - BUS

A

													
<b>MERCEDES-BENZ</b>													
<b>1314 ...</b>													
	VL 3/12 D-53 VL 3/12 D-53 HL 4/05 D-9.2 HL 4/05 D-9.2 HL 4/29 D-92 HL 4/35 D-92	SET1113 SET1108		SET1091 SET1115 SET1103 SET1091		I O I O I I							
<b>1314 K</b>													
	VL 3/11 D-44 VL 3/11 D-44 VL 3/12 D-53 VL 3/12 D-53 HL 4/05 D-9.2 HL 4/05 D-9.2 HL 4/29 D-92 HL 4/35 D-92	SET1113 SET1108 SET1113 SET1108		SET1091 SET1115 SET1103 SET1091		I O I O I O I I							
<b>1314 K0</b>													
	VL 3/12 D-53 VL 3/12 D-53 HL 4/29 D-92 HL 4/35 D-92	SET1113 SET1108		SET1103 SET1091		I O I I							
<b>1314 L</b>													
	VL 3/11 D-44 VL 3/11 D-44 VL 3/12 D-53 VL 3/12 D-53 HL 4/05 D-9.2 HL 4/05 D-9.2 HL 4/29 D-92 HL 4/35 D-92	SET1113 SET1108 SET1113 SET1108		SET1091 SET1115 SET1103 SET1091		I O I O I O I I							
<b>1314 LK0</b>													
	VL 3/12 D-53 VL 3/12 D-53 HL 4/29 D-92 HL 4/35 D-92	SET1113 SET1108		SET1103 SET1091		I O I I							
<b>1317</b>													
	VL 3/11 D-44 VL 3/11 D-44 VL 3/12 D-53 VL 3/12 D-53 HL 4/05 D-9.2 HL 4/05 D-9.2 HL 4/29 D-92 HL 4/35 D-92	SET1113 SET1108 SET1113 SET1108		SET1091 SET1115 SET1103 SET1091		I O I O I O I I							
<b>1317 K</b>													
	VL 3/11 D-44 VL 3/11 D-44 VL 3/12 D-53 VL 3/12 D-53	SET1113 SET1108 SET1113 SET1108				I O I O							















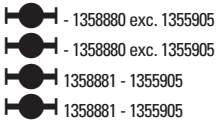

						
<b>MERCEDES-BENZ</b>						
<b>1317 K ...</b>						
	HL 4/05 D-9.2 HL 4/05 D-9.2 HL 4/29 D-92 HL 4/35 D-92			SET1091 SET1115 SET1103 SET1091		
<b>1317 K0</b>						
	VL 3/12 D-53 VL 3/12 D-53 HL 4/29 D-92 HL 4/35 D-92	SET1113 SET1108		SET1103 SET1091		
<b>1317 S</b>						
	VL 3/11 D-44 VL 3/11 D-44 VL 3/12 D-53 VL 3/12 D-53 HL 4/05 D-9.2 HL 4/05 D-9.2 HL 4/29 D-92 HL 4/35 D-92	SET1113 SET1108 SET1113 SET1108		SET1091 SET1115 SET1103 SET1091		
<b>1320</b>						
	VL 3/11 D-44 VL 3/11 D-44 VL 3/12 D-53 VL 3/12 D-53 HL 4/05 D-9.2 HL 4/05 D-9.2	SET1113 SET1108 SET1113 SET1108		SET1091 SET1115		
<b>1320 L</b>						
	VL 3/11 D-44 VL 3/11 D-44 VL 3/12 D-53 VL 3/12 D-53 VL 3/13 D-56 VL 3/13 D-56 VL 3/13 D-56 VL 3/13 D-56 HL 4/05 D-9.2 HL 4/05 D-9.2	SET1113 SET1108 SET1113 SET1108 SET1114 SET1109 SET1114 SET1110		SET1091 SET1115		 - 1358880 exc. 1355905  - 1358880 exc. 1355905  1358881 - 1355905  1358881 - 1355905
<b>1320 LS</b>						
	VL 3/11 D-44 VL 3/11 D-44 VL 3/12 D-53 VL 3/12 D-53 HL 4/05 D-9.2 HL 4/05 D-9.2	SET1113 SET1108 SET1113 SET1108		SET1091 SET1115		
<b>1320 S</b>						
	VL 3/11 D-44 VL 3/11 D-44 VL 3/12 D-53 VL 3/12 D-53	SET1113 SET1108 SET1113 SET1108				

A

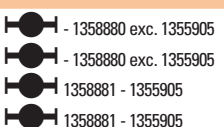

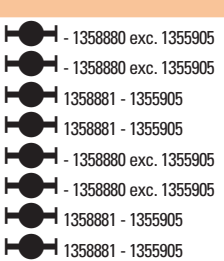

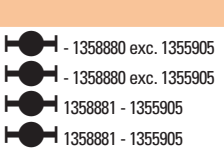

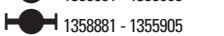

















# APPLICATION LISTINGS - BUS

A



































						
<b>MERCEDES-BENZ</b>						
<b>1320 S ...</b>						
	HL 4/05 D-9.2 HL 4/05 D-9.2		SET1091 SET1115			
<b>1514 L</b>						
	VL 3/13 D-56 VL 3/13 D-56 VL 3/13 D-56 VL 3/13 D-56 HL 4/08 D-106 HL 4/08 D-106 HL 4/32 D-106 HL 4/32 D-106 HL 4/35 D-106 HL 4/35 D-106	SET1114 SET1109 SET1114 SET1110	SET1092 SET1103 SET1091 SET1115 SET1092 SET1115			 - 1358880 exc. 1355905 - 1358880 exc. 1355905 1358881 - 1355905 1358881 - 1355905
<b>1517</b>						
	VL 3/13 D-56 VL 3/13 D-56 VL 3/13 D-56 VL 3/13 D-56 HL 4/08 D-106 HL 4/08 D-106 HL 4/32 D-106 HL 4/32 D-106 HL 4/35 D-106 HL 4/35 D-106	SET1114 SET1109 SET1114 SET1110	SET1092 SET1103 SET1091 SET1115 SET1092 SET1115			 - 1358880 exc. 1355905 - 1358880 exc. 1355905 1358881 - 1355905 1358881 - 1355905
<b>1520</b>						
	VL 3/13 D-56 VL 3/13 D-56 VL 3/13 D-56 VL 3/13 D-56 VL 3/15 D-65 VL 3/15 D-65 VL 3/15 D-65 VL 3/15 D-65 HL 4/08 D-106 HL 4/08 D-106	SET1114 SET1109 SET1114 SET1110 SET1114 SET1109 SET1114 SET1110	SET1092 SET1103			 - 1358880 exc. 1355905 - 1358880 exc. 1355905 1358881 - 1355905 1358881 - 1355905 - 1358880 exc. 1355905 - 1358880 exc. 1355905 1358881 - 1355905 1358881 - 1355905
<b>1520 L</b>						
	VL 3/13 D-56 VL 3/13 D-56 VL 3/13 D-56 VL 3/13 D-56 HL 4/08 D-106 HL 4/08 D-106	SET1114 SET1109 SET1114 SET1110	SET1092 SET1103			 - 1358880 exc. 1355905 - 1358880 exc. 1355905 1358881 - 1355905 1358881 - 1355905
<b>1524</b>						
	VL 3/13 D-56 VL 3/13 D-56 VL 3/13 D-56 VL 3/13 D-56 HL 4/08 D-106 HL 4/08 D-106	SET1114 SET1109 SET1114 SET1110	SET1092 SET1103			 - 1358880 exc. 1355905 - 1358880 exc. 1355905 1358881 - 1355905 1358881 - 1355905

















													
<b>MERCEDES-BENZ</b>													
<b>1720</b>													
	VL 3/13 D-56	SET1114											- 1358880 exc. 1355905
	VL 3/13 D-56	SET1109											- 1358880 exc. 1355905
	VL 3/13 D-56	SET1114											1358881 - 1355905
	VL 3/13 D-56	SET1110											1358881 - 1355905
	VL 3/15 D-65	SET1114											- 1358880 exc. 1355905
	VL 3/15 D-65	SET1109											- 1358880 exc. 1355905
	VL 3/15 D-65	SET1114											1358881 - 1355905
	VL 3/15 D-65	SET1110											1358881 - 1355905
	HL 4/08 D-106					SET1092							
	HL 4/08 D-106					SET1103							
<b>2020 L</b>													
	VL 3/11 D-44	SET1113											
	VL 3/11 D-44	SET1108											
	VL 3/12 D-53	SET1113											
	VL 3/12 D-53	SET1108											
	VL 3/13 D-56	SET1114											- 1358880 exc. 1355905
	VL 3/13 D-56	SET1109											- 1358880 exc. 1355905
	VL 3/13 D-56	SET1114											1358881 - 1355905
	VL 3/13 D-56	SET1110											1358881 - 1355905
	HL 4/08 D-106					SET1092							
	HL 4/08 D-106					SET1103							
	HL 4/05 D-9.2					SET1091							
	HL 4/05 D-9.2					SET1115							
<b>BH 3 - N</b>													
	VO 3/10 DL-6	SET1114											
	VO 3/10 DL-6	SET1110											
	HO 4/01 DL-10					SET1092							
	HO 4/01 DL-10					SET1103							
<b>BH 4</b>													
	HO 4/01 DL-10					SET1092							
	HO 4/01 DL-10					SET1103							
<b>BH 4 - 23</b>													
	VO 3/10 DL-6	SET1114											
	VO 3/10 DL-6	SET1110											
	HO 4/01 DL-10					SET1092							
	HO 4/01 DL-10					SET1103							
<b>BH 4 - N</b>													
	HO 4/01 DL-10					SET1092							
	HO 4/01 DL-10					SET1103							
<b>BGT - 25</b>													
	VO 4/18 DL-7	SET1301											- 1465149
	VO 4/18 DL-7	SET1110											- 1465149
	VO 4/18 DL-7	SET1301											1465150 -
	VO 4/18 DL-7	SET1079											1465150 -
	HO 7/01 DL-10					SET1093							
	HO 7/01 DL-10					SET1049							

# APPLICATION LISTINGS - BUS

A

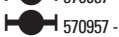
						
<b>MERCEDES-BENZ</b>						
<b>BGT - N 2</b>						
	VO 4/33 DL-6.6 VO 4/33 DL-6.6 VO 4/33 DL-6.6 VO 4/33 DL-6.6 HO 7/01 DL-11.5 HO 7/01 DL-11.5	SET1301 SET1110 SET1301 SET1079		SET1093 SET1049		 - 1465149  - 1465149  1465150 -  1465150 -
<b>BGU - 25</b>						
	VO 4/18 DL-7 VO 4/18 DL-7 VO 4/18 DL-7 VO 4/18 DL-7 HO 7/01 DL-10 HO 7/01 DL-10	SET1301 SET1110 SET1301 SET1079		SET1093 SET1049		 - 1465149  - 1465149  1465150 -  1465150 -
<b>BT - 25</b>						
	VO 4/18 DL-7 VO 4/18 DL-7 VO 4/18 DL-7 VO 4/18 DL-7 HO 7/01 DL-10 HO 7/01 DL-10	SET1301 SET1110 SET1301 SET1079 SET1093 SET1049				 - 1465149  - 1465149  1465150 -  1465150 -
<b>BU 5 - 25</b>						
	VO 4/18 DL-7 VO 4/18 DL-7 VO 4/18 DL-7 VO 4/18 DL-7 HO 7/01 DL-10 HO 7/01 DL-10	SET1301 SET1110		SET1301 SET1079 SET1093 SET1049		 - 1465149  - 1465149  1465150 -  1465150 -
<b>CBC FAHRGESTELL 2 - AC</b>						
	VO 4/39 CL-75 VO 4/39 CL-75 HO 6/6 DCL [S]-13 HO 6/6 DCL [S]-13 HO 6/DCL-13	SET1301 SET1079		SET1094 SET1094 SET1094		SA 40430423, SA 50435107 SA 40430423, SA 50435107  - M053279, N287999  M053280, N288000 -
<b>CITARO [O 530]</b>						
	VO 4/39 CL-7.5 VO 4/39 CL-75 VO 4/39 CL-75 HO 6/6 DCL [S]-13 HO 6/6 DCL [S]-13 ZF-RL-75/EC	SET1301 SET1301 SET1079		SET1094 SET1094 SET1081		 - M053279, N287999  M053280, N288000 -
<b>CITARO [O 530] G</b>						
	VO 4/36CL-7 VO 4/36CL-7 VO 4/39 CL-75 VO 4/39 CL-75	SET1301 SET1079 SET1301 SET1079				









					
<b>MERCEDES-BENZ</b>					
<b>CITARO [0 530] GNG</b>					
	VO 4/36CL-7 VO 4/36CL-7 VO 4/39 CL-75 VO 4/39 CL-75	SET1301 SET1079 SET1301 SET1079			
<b>CITARO [0 530] L</b>					
	VO 4/36 CL-7 VO 4/36 CL-7 VO 4/39 CL-75 VO 4/39 CL-75 ZF-RL-75/A	SET1301 SET1079 SET1301 SET1079	SET1081		
<b>CITARO [0 530] N</b>					
	VO 4/36 CL-7 VO 4/36 CL-7 VO 4/39 CL-75 VO 4/39 CL-75	SET1301 SET1079 SET1301 SET1079			
<b>CITARO [0 530] N3</b>					
	VO 4/36 CL-7 VO 4/36 CL-7 VO 4/39 CL-75 VO 4/39 CL-75	SET1301 SET1079 SET1301 SET1079			
<b>CITARO [0 530] NG</b>					
	VO 4/36 CL-7 VO 4/36 CL-7 VO 4/39 CL-75 VO 4/39 CL-75	SET1301 SET1079 SET1301 SET1079			
<b>CONNECTO [O 345]</b>					
	VO 4/34 DL-7 VO 4/34 DL-7 VO 4/34 DL-7 HO 7/10 D-115 HO 7/10 D-115 HO 7/10 DL-11.5 HO 7/10 DL-11.5 NR 7/5 DL-10 NR 7/5 DL-10 NR 7/5 DL-10 NR 7/5 DL-10	SET1301 SET1301 SET1079	SET1093 SET1049 SET1093 SET1049 SET1093 SET1049 SET1093 SET1049		 570957 -  570957 -
<b>CONNECTO [O 345] C, H, M, UE</b>					
	VO 4/34 DL-7 VO 4/34 DL-7	SET1301 SET1079			
<b>INTEGRO INTOURO</b>					
	HO 6/4 DCL [S]-13		SET1094		

A







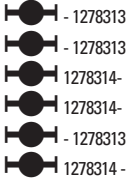

















































# APPLICATION LISTINGS - BUS

A







































































 							
<b>MERCEDES-BENZ</b>							
<b>O 301</b>							
	VO 3/9 DL-5 VO 3/9 DL-5 VL 1/3-2.1 VL 1/3-2.1 VL 1/3-2.1 VL 1/3-2.1 VL 1/4-1.6 VL 1/4-1.6 VL 1/4-1.6  VL 1/4-1.6  VL 1/4-1.6 VL 1/4-1.6 VL 1/5-2.3 VL 1/5-2.3 VL 1/6-2.3 VL 1/6-2.3 VL 1/7-2.6 VL 1/7-2.6 VL 2/11 D-3.8 VL 2/11 D-3.8 HL 1/2-3.3 HL 1/2-3.3 HL 1/3-4.5 HL 1/3-4.5 HL 2/5-4.5 HL 2/5-4.5 HL 2/9-4.7 HL 2/9-4.7	SET1113 SET1108 2789/2720 SET226 SET1097 33205 32208 SET1072 2789/2720  SET226  SET1097 33205 SET1097 33205 SET1097 33205 SET1097 33205 SET1111 EK50029			SET1060 32210 SET98 SET272 SET98 SET272 SET98 SET272		-Ch.48630 -Ch.48630 Ch.48631- Ch.48631- -Ch.17768 Diesel, -Ch.1288 Petrol -Ch.17768 Diesel, -Ch.1288 Petrol Ch.17769-Ch.17814 Diesel, Ch.1289-Ch.4706 Petrol Ch.17769-Ch.17814 Diesel, Ch.1289-Ch.4706 Petrol Ch.17815- Diesel, Ch.4707- Petrol Ch.17815- Diesel, Ch.4707- Petrol
<b>O 303</b>							
	VO 3/10 DL-6 VO 3/10 DL-6 VO 3/10 DL-6 VO 3/10 DL-6 VO 3/10 DL-6 VO 3/9 DL-5 VO 3/9 DL-5 VO 3/9 DL-5 VO 4/13 DL-7 VO 4/13 DL-7 VO 4/13 DL-7 VO 4/13 DL-7 VO 4/13 DL-7 VO 4/13 DL-7 VO 4/13 DL-7 VL 1/3-2.1 VL 1/3-2.1 VL 1/3-2.1 VL 1/3-2.1 VL 1/4-1.6 VL 1/4-1.6 VL 1/4-1.6	SET1114 SET1109 SET1114 SET1110 SET1109 SET1113 SET1108 SET1108 SET1301 SET1110 SET1301 SET1079 SET1301 SET1301 2789/2720 SET226 SET1097 33205 32208 SET1072 2789/2720				 - 1390839 - 1390839 1390840- 1390840- - 1390839   - 1278313 - 1278313 1278314- 1278314- - 1278313 1278314 -  -Ch.48630 -Ch.48630 Ch.48631- Ch.48631- -Ch.17768 Diesel, -Ch.1288 Petrol -Ch.17768 Diesel, -Ch.1288 Petrol Ch.17769-Ch.17814 Diesel, Ch.1289-Ch.4706 Petrol	













 		  			
<b>MERCEDES-BENZ</b>					
<b>O 303 ...</b>					
	VL 1/4-1.6 VL 1/4-1.6 VL 1/4-1.6 VL 1/5-2.3 VL 1/5-2.3 VL 1/6-2.3 VL 1/6-2.3 VL 1/7-2.6 VL 1/7-2.6 VL 2/11 D-3.8 VL 2/11 D-3.8 HO 4/01 DL-10 HO 4/01 DL-10 HO 4/10 DL-10 HO 4/10 DL-10 HO 4/10 DL-10 HO 4/10 DL-10 HO 4/10 L-10 HO 4/10 L-10 HO 4/18 DL-7.7 HO 4/18 DL-7.7 HO 4/18 DL-7.7 HO 4/18 L-7.7 HO 4/18 L-7.7 HO 5/8 DL-10 HO 5/8 DL-10 HO 5/8 DL-10 HO 5/8 L-10 HO 5/8 L-10 HL 1/2-3.3 HL 1/2-3.3 HL 1/3-4.5 HL 1/3-4.5 HL 2/5-4.5 HL 2/5-4.5 HL 2/9-4.7 HL 2/9-4.7	SET226  SET1097 33205 SET1097 33205 SET1097 33205 SET1097 33205 SET1111 EK50029		                              	Ch.17769-Ch.17814 Diesel, Ch.1289-Ch.4706 Petrol Ch.17815- Diesel, Ch.4707- Petrol Ch.17815- Diesel, Ch.4707- Petrol
<b>O 305/307</b>					
	VO 4/11 DL-7 VO 4/11 DL-7 VO 4/11 DL-7 VO 4/11 DL-7 HO 7/8 DL-10 HO 7/8 DL-10 NR 7/4 DL-10 NR 7/4 DL-10 NR 7/5 DL-10 NR 7/5 DL-10	SET1301 SET1110 SET1301 SET1079		        	 - 1278313  - 1278313  1278314-  1278314-
<b>O 309/309 D</b>					
	VO 3/9 DL-5 VO 3/9 DL-5 VL 1/3-2.1	SET1113 SET1108 2789/2720		  	-Ch.48630



A

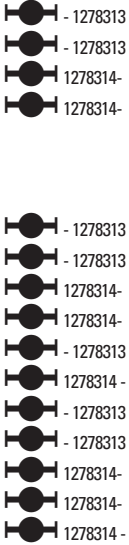





























						
<b>MERCEDES-BENZ</b>						
<b>O 309/309 D ...</b>						
VL 1/3-2.1		<b>SET226</b>				-Ch.48630
VL 1/3-2.1		<b>SET1097</b>				Ch.48631-
VL 1/3-2.1		<b>33205</b>				Ch.48631-
VL 1/4-1.6		<b>32208</b>				-Ch.17768 Diesel, -Ch.1288 Petrol
VL 1/4-1.6		<b>SET1072</b>				-Ch.17768 Diesel, -Ch.1288 Petrol
VL 1/4-1.6		<b>2789/2720</b>				Ch.17769-Ch.17814 Diesel,
						Ch.1289-Ch.4706 Petrol
VL 1/4-1.6		<b>SET226</b>				Ch.17769-Ch.17814 Diesel,
						Ch.1289-Ch.4706 Petrol
VL 1/4-1.6		<b>SET1097</b>				Ch.17815- Diesel, Ch.4707- Petrol
VL 1/4-1.6		<b>33205</b>				Ch.17815- Diesel, Ch.4707- Petrol
VL 1/5-2.3		<b>SET1097</b>				
VL 1/5-2.3		<b>33205</b>				
VL 1/6-2.3		<b>SET1097</b>				
VL 1/6-2.3		<b>33205</b>				
VL 1/7-2.6		<b>SET1097</b>				
VL 1/7-2.6		<b>33205</b>				
VL 2/11 D-3.8		<b>SET1111</b>				
VL 2/11 D-3.8		<b>EK50029</b>				
HL 1/2-3.3			<b>SET1060</b>			
HL 1/2-3.3			<b>32210</b>			
HL 1/3-4.5			<b>SET98</b>			
HL 1/3-4.5			<b>SET272</b>			
HL 2/5-4.5			<b>SET98</b>			
HL 2/5-4.5			<b>SET272</b>			
HL 2/9-4.7			<b>SET98</b>			
HL 2/9-4.7			<b>SET272</b>			
<b>O 402</b>						
VL 2/11 D-3.8		<b>SET1111</b>				
VL 2/11 D-3.8		<b>EK50029</b>				
VO 4/18 DL-7			<b>SET1301</b>			
VO 4/18 DL-7			<b>SET1079</b>			
VO 4/22 DLE-6.6			<b>SET1301</b>			
VO 4/22 DLE-6.6			<b>SET1079</b>			
<b>O 404</b>						
VO 4/21 CLE-6.6		<b>SET1307</b>				 - 1278313
VO 4/21 CLE-6.6		<b>SET1110</b>				 - 1278313
VO 4/21 CLE-6.6		<b>SET1307</b>				 1278314-
VO 4/21 CLE-6.6		<b>SET1079</b>				 1278314-
VO 4/22 DLE-6.6		<b>SET1301</b>				 - 1278313
VO 4/22 DLE-6.6		<b>SET1110</b>				 - 1278313
VO 4/22 DLE-6.6		<b>SET1301</b>				 1278314-
VO 4/22 DLE-6.6		<b>SET1079</b>				 1278314-
VO 4/22 DLE-6.6		<b>SET1301</b>				 - 1465149
VO 4/22 DLE-6.6		<b>SET1301</b>				 - 1465150
VO 4/35 CLE-7.5		<b>SET1307</b>				 - 1278313
VO 4/35 CLE-7.5		<b>SET1110</b>				 - 1278313
VO 4/35 CLE-7.5		<b>SET1307</b>				 1278314-
VO 4/35 CLE-7.5		<b>SET1079</b>				 1278314-
VL 2/11 D-3.8		<b>SET1111</b>				
VL 2/11 D-3.8		<b>EK50029</b>				
HO 4/01 DL-11.5			<b>SET1092</b>			

					
<b>MERCEDES-BENZ</b>					
<b>O 404 ...</b>					
	HO 4/01 DL-11.5 HO 4/02 CL-11.5 HO 4/02 CL-11.5 HO 4/04 DCL-11.5 HO 4/04 DCL-11.5		SET1103 SET1092 SET1103 SET1092 SET1103		
<b>O 405</b>					
	VO 4/18 DL-7 VO 4/18 DL-7 VO 4/18 DL-7 VO 4/18 DL-7 VO 4/18 DL-7 VO 4/22 DLE-6.6 VO 4/22 DLE-6.6 VO 4/33 DL-6.6 VO 4/33 DL-6.6 VO 4/33 DL-6.6 VO 4/33 DL-6.6 VO 4/33 DL-6.6 VO 4/33 DL-6.6 VO 4/33 DL-6.6 VO 4/34 DL-7 VO 4/34 DL-7 VO 4/34 DL-7 VO 4/34 DL-7 VO 4/34 DL-7 VL 2/11 D-3.8 VL 2/11 D-3.8 HO 7/02 DLM-10 HO 7/02 DLM-10 HO 7/09 DL-10 HO 7/09 DL-10 HO 7/10 DL-11.5 HO 7/10 DL-11.5 NR 7/4 DL-10 NR 7/4 DL-10 NR 7/5 DL-10 NR 7/5 DL-10	SET1301 SET1110 SET1301 SET1110 SET1301 SET1301 SET1079 SET1301 SET1110 SET1301 SET1110 SET1301 SET1301 SET1301 SET1110 SET1301 SET1110 SET1301 SET1111 EK50029	SET1093 SET1049 SET1093 SET1049 SET1093 SET1049 SET1093 SET1049 SET1093 SET1049 SET1093 SET1049		 - 1278313 - 1278313 1278314- 1278314-  - 1278313 - 1278313 1278314- 1278314- - 1278313 1278314 - - 1278313 - 1278313 1278314- 1278314 - 1278313 -
<b>O 407/408</b>					
	VO 4/18 DL-7 VO 4/18 DL-7 VO 4/18 DL-7 VO 4/18 DL-7 VO 4/22 DLE-6.6 VO 4/22 DLE-6.6 VL 2/11 D-3.8 VL 2/11 D-3.8 VL 4/18 DL-7 VL 4/18 DL-7 HO 7/02 DLM-10 HO 7/02 DLM-10 HO 7/09 DL-10 HO 7/09 DL-10 HO 7/10 DL-11.5 HO 7/10 DL-11.5	SET1301 SET1110 SET1301 SET1079 SET1301 SET1079 SET1111 EK50029 SET1301 SET1301	SET1093 SET1049 SET1093 SET1049 SET1093 SET1049		 - 1278313 - 1278313 1278314- 1278314-  - 1278313 1278314 -



























						
<b>MERCEDES-BENZ</b>						
<b>O 1114/1117/1120 ...</b>						
	HL 4/28 D-7.8 HL 4/29 D-9.2 HL 4/29 D-9.2 HL 4/35 D-78 HL 4/35 D-92 HL 4/35 D-92		39586/39528 SET1103 EK50037 SET401 SET1091 EK50037			
<b>O 1317</b>						
	HL 5/1 Z-10 HL 5/1 Z-10		598/592A SET1064			
<b>O 1417</b>						
	HL 4/04 D-12 HL 4/04 D-12		SET1092 SET1103			
<b>O 1617/1625/1628</b>						
	VL 4/2 D-7 VL 4/2 D-7 VO 4/18 DL-7 VO 4/18 DL-7	30314 SET1079 SET1301 SET1079				
<b>OH 1622/1625/1627</b>						
	VO 4/10 D-7 VO 4/10 D-7 VO 4/18 DL-7 VO 4/18 DL-7 VO 4/18 DL-7 VO 4/18 DL-7 VO 4/18 DL-7 HL 4/01 DL-10 HL 4/01 DL-10	SET1301 SET1079 SET1301 SET1079 SET1301 SET1079		SET1092 SET1103		 1278314-  1278314-  - 1278313  - 1278313  1278314-  1278314-
<b>OH 1628/1634</b>						
	VO 4/10 D-7 VO 4/10 D-7 VO 4/18 DL-7 VO 4/18 DL-7 VO 4/18 DL-7 VO 4/18 DL-7 VO 4/18 DL-7 HL 4/01 DL-10 HL 4/01 DL-10	SET1301 SET1079 SET1301 SET1079 SET1301 SET1079		SET1092 SET1103		 1278314-  1278314-  - 1278313  - 1278313  1278314-  1278314-
<b>TOURISMO MBT [O 340]</b>						
	VO 4/13 DL-7 VO 4/13 DL-7 VO 4/13 DL-7 VO 4/13 DL-7 HO 6/4 DCL[S]-13 HO 4/01 DL-10 HO 4/01 DL-10	SET1301 SET1110 SET1301 SET1079		SET1094 SET1092 SET1103		 - 1465149  - 1465149  1465150 -  1465150 -















A



# APPLICATION LISTINGS - BUS

A

















									
<b>MERCEDES-BENZ</b>									
<b>TOURO</b>									
	ZF-RL-75-E HO 6/6 DCL [S]-13 HO 6/6 DCL [S]-13 HO 6/DCL-13	SET1081		SET1094 SET1094 SET1094		 - M053279,N287999  M053280,N288000 -			
<b>TRAVEGO [O 580]</b>									
	HO 6/1 DCL [S]-13 HO 6/1 DCL [S]-13 HO 6/4 DCL [S]-13 HO 6/4 DCL [S]-13 HO 8/1 DCL [S]-13 HO 8/1 DCL [S]-13 ZF-RL-75-E HO 6/1 DCL [S]-13 HO 6/4 DCL [S]-13 HO 8/1 DCL [S]-13 ZF-RL 75/A	SET1094 SET1094 SET1094 SET1094 SET1094 SET1094 SET1081		SET1094 SET1094 SET1094 SET1081		 - M053279,N287999  M053280,N288000 -  - M053279,N287999  M053280,N288000 -  - M053279,N287999  M053280,N288000 -			
<b>VU 4 - 23</b>									
	VO 3/10 DL-6 VO 3/10 DL-6 HO 7/01 DLS-10 HO 7/01 DLS-10	SET1114 SET1110		SET1093 SET1049					
<b>RENAULT RVI</b>									
<b>AGORA CITYBUS</b>									
				SET1166 SET1116					
<b>ER 100 - 2</b>									
	R1 6A R1 6A	SET1113 SET1109		52375/52618 SET109					
<b>FRH</b>									
	R1 65 R R1 65 R PX 1141 PX 1141	SET1114 32309B		SET1166 SET1116		12/92 - 12/92 - 12/92 - 12/92 -			
<b>FRI</b>									
	R1 65 R R1 65 R R1 65 R R1 65 R PX 1141 PX 1141 PX 1141 PX 1141	SET1114 SET1078 SET1114 32309B		SET1166 SET1116 SET1166 SET1116		- 12/85 - 12/85 01/86 - 01/86 - - 12/83 - 12/83 01/84 - 01/84 -			













									
<b>RENAULT RVI</b>									
<b>G 45 / S</b>									
	E6A E6A E6A P 1321 B P 1321 B	SET1114 SET1078 SET1114		52375/52618 SET109		- 14/03/84 - 14/03/84 15/03/84 -			
<b>G 105 / S</b>									
	E6A E6A E6A P 1321 B P 1321 B	SET1114 SET1078 SET1114		52375/52618 SET109		- 14/03/84 - 14/03/84 15/03/84 -			
<b>GX 187</b>									
	R1 6A R1 6A PX 1021/ PX SAR 1021 PX 1021/ PX SAR 1021	SET1113 SET1109		52375/52618 SET109					
<b>GX 317</b>									
				SET1166 SET1116					
<b>MEGABUS</b>									
	R1 6A R1 6A PX 1021/ PX SAR 1021 PX 1021/ PX SAR 1021	SET1113 SET1109		52375/52618 SET109					
<b>PER 180</b>									
	PX 1021/ PX SAR 1021 PX 1021/ PX SAR 1021			52375/52618 SET109					
<b>PG 60 / S</b>									
	E6A E6A E6A P 1321 B P 1321 B	SET1078 SET1114 SET1114		52375/52618 SET109		- 14/03/84 - 14/03/84 15/03/84 -			
<b>PGC 191 / 231</b>									
	E5A E5A P 1021 J P 1021 J	SET1113 SET1109		52375/52618 SET109					
<b>PR 8 C</b>									
	E5A E5A E5A E5A E5A E5A	SET1113 SET1109 SET1113 SET1109 SET1113 SET1110				- 05/91 - 05/91 06/91 - 03/93 06/91 - 03/93 04/93 - 04/93 -			



# APPLICATION LISTINGS - BUS

A

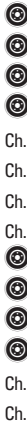





						
<b>RENAULT RVI</b>						
<b>PR 8 C ...</b>						
	P 1140 P 1140		SET1049 SET1103			
<b>PR 10 / 12</b>						
	E5A E5A PX 821 G PX 821 G	SET1113 SET1109		594/593X 594/593X		
<b>PR 14</b>						
	E5A E5A P 1021 / PX 1021 P 1021 / PX 1021	SET1113 SET1109		52375/52618 SET109		
<b>PR 100</b>						
	R1 6A R1 6A R1 6A R1 6A PX 1021/ PX SAR 1021 PX 1021/ PX SAR 1021	JH211749/JH211710 SET1097 JH211749/JH211710 SET1109		52375/52618 SET109		- 08/84 MOT. 62030 - N1539 - 08/84 MOT. 62030 - N1539 - 08/84 MOT. 62030 - N1540 - 08/84 MOT. 62030 - N1540 - 08/84 MOT. 62030 - 08/84 MOT. 62030
<b>PR 100 - 2</b>						
		SET1113 SET1109		52375/52618 SET109		
<b>PR 100 - 3 / 112 / 118</b>						
	PU 04 / PS 08 PU 04 / PS 08		SET1166 SET1116			
<b>PR 180</b>						
	R1 6A R1 6A R1 6A R1 6A PX 1021/ PX SAR 1021 PX 1021/ PX SAR 1021	SET1113 SET1109 JH211749/JH211710 SET1109		52375/52618 SET109		- 08/84 MOT. 62030 - 08/84 MOT. 62030
<b>TRACER</b>						
			SET1166 SET1103 SET1166 SET1116			
<b>SCANIA</b>						
<b>B/BF 86</b>						
	AM 55 AM 55 AM 55	SET1076 SET1080 SET1076				⊕ - Ch.1850412 ⊕ Ch.1850413 - ⊕ Ch.1850413 -











































































































									
<b>SCANIA</b>									
<b>B/BF 86 ...</b>									
	AM 60 AM 60 R 640 R 640 R 640 R 640 R 653 R 653	SET1081 SET1078		SET1065 SET1064 SET1065 SET1115 SET1067 SET1067				- Ch.1850412 - Ch.1850412 Ch.1850413 - Ch.1850413 - - Ch.1850412 - Ch.1850412	
<b>B 111</b>									
	R 640 R 640 R 640 R 640 R 640 R 640 R 653 R 653 R 653 R 653 R 653 R 653	SET1076		SET1065 SET1064 SET1065 SET1115 SET1065 SET1115 SET1067 SET1067 SET1067 SET1067 HM218248Z/HM218210 HM218248Z/HM218210				- Ch.1871409 - Ch.1871409 - Ch.1871409 Ch.1871410 - Ch.1871595 Ch.1871410 - Ch.1871595 Ch.1871596 - Ch.1871596 - - Ch.1871409 - Ch.1871409 - Ch.1871409 - Ch.1871409 Ch.1871410 - Ch.1871410 -	
<b>BF 111/CKD</b>									
	R 640 R 640 R 640 R 640 R 640 R 653 R 653 R 653 R 653 R 653 R 653 R 653	SET1081 SET1078		SET1065 SET1064 SET1065 SET1115 SET1065 SET1115 SET1067 SET1067 SET1067 SET1067 HM218248Z/HM218210 HM218248Z/HM218210				- Ch.1871409 - Ch.1871409 Ch.1871410 - Ch.1871595 Ch.1871410 - Ch.1871595 Ch.1871596 - Ch.1871596 - - Ch.1871409 - Ch.1871409 - Ch.1871409 - Ch.1871409 Ch.1871410 - Ch.1871410 -	
<b>BR 86</b>									
	R 640 R 640 R 640 R 640 R 653 R 653	SET1081 SET1078 SET1081 SET1078 SET1076 SET1080 SET1076		SET1065 SET1064 SET1065 SET1115 SET1067 SET1067				Ch.1802873 - Ch.1802873 - - Ch.1801229 Ch.1801230 - Ch.1801230 - - Ch.1801229 - Ch.1801229 Ch.1801230 - Ch.1801230 -	



# APPLICATION LISTINGS - BUS

A

     	
<b>SCANIA</b>	
<b>BR 86 ...</b>	
R 653 R 653 R 653 R 653	<b>SET1067</b> <b>SET1067</b> <b>HM218248Z/HM218210</b> <b>HM218248Z/HM218210</b>
<b>BR/N 112</b>	
R 653 R 653 R 653 R 653 TRAILING AXLE TRAILING AXLE	<b>SET1081</b> <b>SET1078</b> <b>SET1081</b> <b>SET1078</b>  <b>SET1067</b> <b>SET1067</b> <b>HM218248Z/HM218210</b> <b>HM218248Z/HM218210</b> <b>HM218248Z/HM218210</b> <b>HM218248Z/HM218210</b>
<b>BR 116</b>	
R 653 / R 750 R 653 / R 750 R 653 / R 750 R 653 / R 750	<b>SET1081</b> <b>SET1078</b> <b>SET1081</b> <b>SET1078</b> <b>SET1081</b> <b>SET1078</b> <b>SET1076</b> <b>SET1080</b> <b>SET1076</b>  <b>HM218248Z/HM218210</b> <b>HM218248Z/HM218210</b> <b>SET1067</b> <b>SET1067</b>
<b>F/S 82 CL</b>	
AM 60 AM 60 R 642 / R 653 R 642 / R 653	<b>SET1081</b> <b>SET1078</b>  <b>HM218248Z/HM218210</b> <b>HM218248Z/HM218210</b>
<b>F/S 112 CL</b>	
AM 55 AM 55 AM 55 AM 55 AM 60 AM 60 R 642 / R 653 / R 750 R 642 / R 653 / R 750	<b>SET1080</b> <b>SET1076</b> <b>SET1080</b> <b>SET1076</b> <b>SET1081</b> <b>SET1078</b>  <b>HM218248Z/HM218210</b> <b>HM218248Z/HM218210</b>
<b>K 82</b>	
AM 60 AM 60 R 750 R 750 R 642 / R 653	<b>SET1081</b> <b>SET1078</b>  <b>HM218248Z/HM218210</b> <b>HM218248Z/HM218210</b> <b>HM218248Z/HM218210</b>



































































					
<b>SCANIA</b>					
<b>K 82 ...</b>					
	R 642 / R 653		HM218248Z/HM218210		
<b>K 112 CLB</b>					
	R 653 / R 750 R 653 / R 750	SET1081 SET1078	HM218248Z/HM218210 HM218248Z/HM218210	   	
<b>K 113 CLB</b>					
	AM 56 AM 56 AM 61 / AMA 61 AM 61 / AMA 61 AM 61 / AMA 61 AMA 56 AMA 56 AMA 56 AMA 56 AD 90 / ADA 90 AD 90 / ADA 90	SET1163 SET1078 SET1081 SET1078 SET1081 SET1078 SET1163 SET1078 SET1163 SET1078	HM218248Z/HM218210 HM218248Z/HM218210	                 	 22.5"   22.5"     22.5"   22.5"   22.5"   22.5"  -Ch.1801229 -Ch.1801229
<b>K 113 TLA/TLB</b>					
	AMA 56 AMA 56 AMA 56 AMA 56 AMA 61 AMA 61 AMA 61 AMA 61 ADA 90 ADA 90 TRAILING AXLE TRAILING AXLE	SET1163 SET1078 SET1163 SET1078 SET1081 SET1078 SET1081 SET1078 SET1081 SET1078 SET1081 SET1078	HM218248Z/HM218210 HM218248Z/HM218210 SET1081 SET1078	                 	 8.25x22.5"   8.25x22.5"   8.25x22.5"   8.25x22.5"   8.25x22.5"   8.25x22.5"   8.25x22.5"   9x22.5"   9x22.5"   9x22.5"   9x22.5"  -Ch.1801229 -Ch.1801229 -Ch.1801229 -Ch.1801229
<b>K 92 CL/CR</b>					
		SET1081 SET1078	HM218248Z/HM218210 HM218248Z/HM218210	   	  -Ch.1801229 -Ch.1801229
<b>K 93 CRB</b>					
	AM 56 AM 56 AM 56 AM 56 AM 61 / AMA 61 AM 61 / AMA 61 AM 61 / AMA 61	SET1163 SET1078 SET1163 SET1078 SET1081 SET1078 SET1081		      	   8   8   8   8 

A



































# APPLICATION LISTINGS - BUS

A

						
<b>SCANIA</b>						
<b>K 93 CRB ...</b>						
	AM 61 / AMA 61 AD 90 / ADA 90 AD 90 / ADA 90	SET1078		HM218248Z/HM218210 HM218248Z/HM218210	  	 8 -Ch.1801229 -Ch.1801229
<b>L 113 B</b>						
	AM 61 / AMA 61 AM 61 / AMA 61 AM 61 / AMA 61 AM 61 / AMA 61 AMA 56 AMA 56 AMA 56 AMA 56 AD 90 / ADA 90 AD 90 / ADA 90	SET1081 SET1078 SET1081 SET1078 SET1163 SET1078 SET1163 SET1078		HM218248Z/HM218210 HM218248Z/HM218210	         	        -Ch.1801229 -Ch.1801229
<b>N 111 AL</b>						
	R 653 R 653	SET1081 SET1078		HM218248Z/HM218210 HM218248Z/HM218210 HM218248Z/HM218210 HM218248Z/HM218210	     	-Ch.1808901, Ch.1808902 - -Ch.1808901, Ch.1808902 - - Ch.1806768, Ch.1806769 - - Ch.1806768, Ch.1806769 -
<b>N 112 CLB</b>						
	R 653 / R 750 R 653 / R 750	SET1081 SET1078		HM218248Z/HM218210 HM218248Z/HM218210	   	 -Ch.1808901, Ch.1808902 -  -Ch.1808901, Ch.1808902 - - Ch.1806768, Ch.1806769 - - Ch.1806768, Ch.1806769 -
<b>N 113 ALB</b>						
	AMA 56 AMA 56 AMA 56 AMA 56 AMA 56 AMA 56 AMA 56 ADA 90 ADA 90 ASA 90 ASA 90	SET1163 SET1078 SET1163 SET1078 SET1081 SET1078 SET1081 SET1078		HM218248Z/HM218210 HM218248Z/HM218210 HM218248Z/HM218210 HM218248Z/HM218210	          	6.5 T 6.5 T  6.5 T  6.5 T 7.1 T 7.1 T 6.5 T - Ch.1820117 6.5 T - Ch.1820117  ABS  ABS -Ch.1801229 -Ch.1801229
<b>N 113 CLB/CRB</b>						
	AMA 56 AMA 56 AMA 56 AMA 56 AMA 56 AMA 56 AMA 56 AMA 56 AMA 56	SET1163 SET1078 SET1163 SET1078 SET1163 SET1078 SET1081 SET1078 SET1081			       	6.5 T - Ch.1820117 6.5 T - Ch.1820117 6.5 T - Ch.1820117  6.5 T - Ch.1820117   7.1 T - Ch.1820117 7.1 T - Ch.1820117 7.1 T - Ch.1820117 















































									
<b>SCANIA</b>									
<b>N 113 CLB/CRB ...</b>									
	AMA 56 AMA 61 AMA 61 AMA 61 AMA 61 ADA 90 ADA 90	SET1078 SET1081 SET1078 SET1081 SET1078		HM218248Z/HM218210 HM218248Z/HM218210		7.1 T - Ch.1820117  Ch.1820118 -  Ch.1820118 -  Ch.1820118 - ABS  Ch.1820118 - ABS  - Ch.1820117 - Ch.1820117			
<b>S 82 HR</b>									
	AM 55 AM 55 R 653 R 653	SET1080 SET1076		HM218248Z/HM218210 HM218248Z/HM218210		   			
<b>VOLVO</b>									
<b>B 6</b>									
		SET1165 SET276 32210 32207				Ch.865 [exc.873-875]  Ch.865 [exc.873-875] 			
<b>B 6 F</b>									
		SET1165 SET276 32210 32207		SET1089 33013		Ch.865 [exc.873-875]  Ch.865 [exc.873-875] 			
<b>B 6 FA</b>									
		SET1176 32208 SET1108		SET1090 SET1089 SET1090 SET1089 SET1094 SET1128 SET276		Ch.5000 - -Ch.404  6772232 -Ch.404  6772232 -Ch.404  6010088 -Ch.404  6010088 Ch.405 - Ch.5000 - Ch.5000 -			
<b>B 7</b>									
		SET1165 SET276		SET216 SET401		Ch.20000 - Ch.20000 - Ch.20000 - Ch.20000 -			
<b>B 7 F/FA</b>									
		6386/6320 SET212 SET1165 SET276				- Ch.10521  - Ch.10521  Ch.10522 -  Ch.10522 - 			



# APPLICATION LISTINGS - BUS

A

						
<b>VOLVO</b>						
<b>B 7 F/FA ...</b>						
				SET109 SET405		
<b>B 7 R</b>						
		SET1165 SET276		SET109 SET405		 
<b>B 9 M/10 M</b>						
	TRAILING AXLE TRAILING AXLE TRAILING AXLE TRAILING AXLE TRAILING AXLE TRAILING AXLE TRAILING AXLE TRAILING AXLE	SET1165 SET276 6386/6320 SET212		SET1165 SET276 SET1165 SET276 6386/6320 SET212 SET109 SET405		 Rear Steer  Rear Steer  Rear Steer  Rear Steer  Rear Steer  Rear Steer   Rear Steer  Rear Steer
<b>B 10 B/BL/L</b>						
	TRAILING AXLE TRAILING AXLE TRAILING AXLE TRAILING AXLE TRAILING AXLE TRAILING AXLE TRAILING AXLE TRAILING AXLE	SET1165 SET276 6386/6320 SET212		SET1165 SET276 SET1165 SET276 6386/6320 SET212 SET109 SET405		 Rear Steer  Rear Steer  Rear Steer  Rear Steer  Rear Steer  Rear Steer   Rear Steer  Rear Steer
<b>B 10 R</b>						
		SET1165 SET276 SET1165 SET276 6386/6320 SET212		SET109 SET405		Ch.3906 - Ch.3906 - Ch.4308 -  Ch.4308 -  - Ch.3906 - Ch.3906
<b>B 12</b>						
	TRAILING AXLE TRAILING AXLE	SET1165 SET276		SET1165 SET276 SET109 SET405		

									
<b>VOLVO</b>									
<b>B/BB 57</b>									
		6386/6320 SET212 6386/6320 SET212		SET216 SET401 SET216 SET401 SET216 SET401		- Ch.7980 - Ch.7980 Ch.7981 - Ch.7981 - Ch.7981 - Ch.7981 - - Ch.3404 - Ch.3404 Ch.3405 - Ch.7980 Ch.3405 - Ch.7980			
<b>B 58</b>									
		6386/6320 SET212		SET216 SET401 SET216 SET401 SET216 SET401		Ch.5257 - Ch.5257 -   - Ch.5256 - Ch.5256			
<b>B 59</b>									
		6386/6320 SET212		SET109 SET405					
<b>B 609/610</b>									
				SET1089 33013					

A





APPLICATION LISTINGS - LIGHT COMMERCIAL VEHICLE

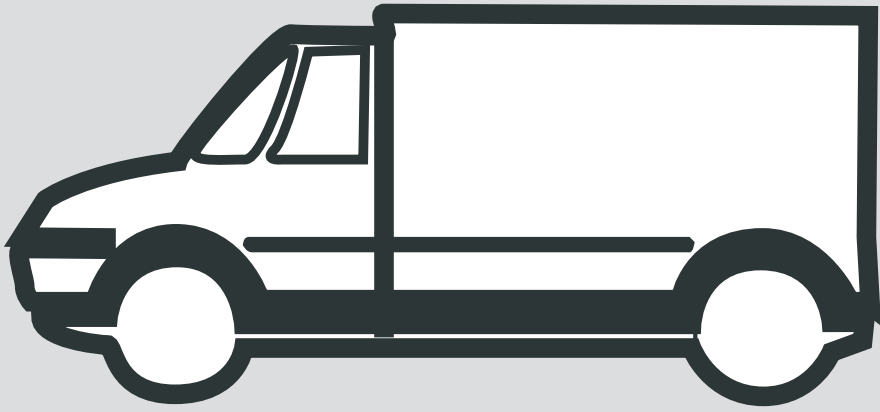







A



APPLICATION LISTINGS - LIGHT COMMERCIAL VEHICLE



# APPLICATION LISTINGS - LIGHT COMMERCIAL VEHICLE













									
									
<b>CITROEN</b>									
<b>C25</b>									
	1000	XAA32010X							- Ch. 604496
	1000	XAA32010X							- Ch. 604496
	1000	XAA32010X							Ch. 604497 -
	1000	XAA32010X							Ch. 604497 -
	1300	XAA32010X							- Ch. 604496
	1300	XAA32010X							- Ch. 604496
	1400	XAA32010X							- Ch. 604496
	1400	XAA32010X							- Ch. 604496
	1400	XAA32010X							Ch. 604497 -
	1400	XAA32010X							Ch. 604497 -
	1800	XAA32010X							- Ch. 604496
	1800	XAA32010X							- Ch. 604496
	1800	XAA32010X							Ch. 604497 -
	1800	XAA32010X							Ch. 604497 -
	1000		XAA32008X						- Ch. 289710
	1000		32006X						- Ch. 289710
	1000		XAA32008X						Ch. 289711 -
	1000		32006X						Ch. 289711 -
	1300		XAA32008X						- Ch. 289710
	1300		32006X						- Ch. 289710
	1300		XAA32008X						Ch. 289711 -
	1300		32006X						Ch. 289711 -
	1400		XAA32008X						
	1400		32006X						
	1800		XAA33108						
	1800		32206						
<b>JUMPER</b>									
	1000 / 1400KG	XAA32010X							
	1000 / 1400KG	XAA32010X							
	1800KG	JXC25678CA/Y32011X							
	1800KG	JXC25678CA/Y32011X							
	1000 / 1400KG		XAA32008X						
	1000 / 1400KG		32006X						
	1800KG		XAA33108						
	1800KG		32206						
<b>DAF</b>									
<b>F400 SERIES</b>									
	28 N	L68149/L68110							
	28 N	07087X/07210X							
	206		U497/U460L						
	206		U497/U460L						
	306		18790/18720						
	306		18690/18620						
<b>FORD</b>									
<b>CARGO</b>									
	30	SET54							
	30	LM48548/LM48510							

A









# APPLICATION LISTINGS - LIGHT COMMERCIAL VEHICLE

A

									
									
<b>FORD</b>									
<b>CARGO ...</b>									
	50 N		SET278						
	50 N		SET102						
	50 W		SET278						
	50 W		SET102						
	65		H212749/H212710						
	65		SET123						
	71		H212749/H212710						
	71		SET123						
	130				SET105				
	130				SET98				
	150				SET105				
	150				SET98				
	165				495A/493				
	165				SET98				
	168				495A/493				
	168				SET98				
	195				SET411				
	195				SET408				
	225				SET216				
	225				SET401				
<b>TRANSIT FT 130 - 150</b>									
	51				NP958644-9X048		I		1992 - 1999
	51				NP958644-9X048		O		1992 - 1999
<b>TRANSIT FT 190 - L</b>									
	51				NP958644-9X048		I		1992 - 1999
	51				NP958644-9X048		O		1992 - 1999
<b>TRANSIT 2000 VAN [FA--,FAA--,FAB--,FAC--]</b>									
					XAA32011XM-90NM5		I		01/00-07/06 [+Rear 
					XAA32011XM-90NM5		O		01/00-07/06 [+Rear 
<b>TRANSIT 2000 FLATBED/CHASSIS [FM-,FN-,F_A_,F_B_,F_C_,F_D_]</b>									
					XAA32011XM-90NM5		I		01/00-07/06 [+Rear 
					XAA32011XM-90NM5		O		01/00-07/06 [+Rear 
<b>TRANSIT 2000 BUS</b>									
					XAA32011XM-90NM5		I		01/00-07/06 [+Rear 
<b>IVECO</b>									
<b>DAILY 28 - 8</b>									
			SET1011				I		10/77 - 05/79
			30305				O		10/77 - 05/79
			32208				I		06/79 - 06/81
			30305				O		06/79 - 06/81
	SALISBURY				18790/18720		I		10/77 - 06/81
	SALISBURY				18690/18620		O		10/77 - 06/81
<b>DAILY 30 - 8</b>									
			SET1011				I		10/77 - 05/79
			30305				O		10/77 - 05/79



# APPLICATION LISTINGS - LIGHT COMMERCIAL VEHICLE















					
<b>IVECO</b>					
<b>DAILY 30 - 8 ...</b>					
	IVECO	32208		I	06/79 - 01/97
	IVECO	30305		O	06/79 - 01/97
	SALISBURY	SET201		I	06/81 - 09/84
	SALISBURY	18690/18620		O	06/81 - 09/84
	IVECO		SET1041	I	06/81 - 01/97
	IVECO		SET1041	O	06/81 - 01/97
	SALISBURY 1 AXLE		SET201	I	10/77 - 06/81
	SALISBURY 1 AXLE		18690/18620	O	10/77 - 06/81
<b>DAILY 30 - 9</b>					
	IVECO	32208		I	06/81 - 1988
	IVECO	30305		O	06/81 - 1988
	SALISBURY	SET201		I	06/81 - 09/84
	SALISBURY	18690/18620		O	06/81 - 09/84
	IVECO		SET1041	I	10/84 - 1988
	IVECO		SET1041	O	10/84 - 1988
	SALISBURY 1 AXLE		18790/18720	I	06/81 - 09/84
	SALISBURY 1 AXLE		18690/18620	O	06/81 - 09/84
<b>DAILY 32 - 8</b>					
		SET1011		I	10/77 - 05/79
		30305		O	10/77 - 05/79
		32208		I	06/79 - 06/81
		30305		O	06/79 - 06/81
	SALISBURY 1 AXLE		SET201	I	10/77 - 06/81
	SALISBURY 1 AXLE		18690/18620	O	10/77 - 06/81
<b>DAILY 35 - 8</b>					
		SET1011		I	10/77 - 05/79
		30305		O	10/77 - 05/79
	IVECO	32208		I	06/79 - 02/96
	IVECO	30305		O	06/79 - 02/96
	SALISBURY	SET201		I	06/81 - 09/84
	SALISBURY	18690/18620		O	06/81 - 09/84
	IVECO		SET1041	I	Exc. Ratio 5.22/1, -02/96
	IVECO		SET1041	O	Exc. Ratio 5.22/1, -02/96
	IVECO		SET1098	I	Ratio 5.22/1, -02/96
	IVECO		SET1041	O	Ratio 5.22/1, -02/96
	IVECO		SET1041	I	03/96 - <del>ABS</del>
	IVECO		SET1041	O	03/96 - <del>ABS</del>
	SALISBURY 1 AXLE		18790/18720	I	10/77 - 09/84
	SALISBURY 1 AXLE		18690/18620	O	10/77 - 09/84
	SALISBURY 2 AXLE		387A/382	I	10/77 - 06/81
	SALISBURY 2 AXLE		SET201	O	10/77 - 06/81
<b>DAILY 35 - 8 HEAVY DUTY</b>					
	IVECO	32208		I	
	IVECO	30305		O	
	IVECO		SET1041	I	
	IVECO		SET1041	O	
<b>DAILY 35 - 9</b>					
	IVECO	32208		I	06/81 - 09/84
	IVECO	30305		O	06/81 - 09/84

A

















# APPLICATION LISTINGS - LIGHT COMMERCIAL VEHICLE

A

						
<b>IVECO</b>						
<b>DAILY 35 - 9 ...</b>						
	IVECO IVECO SALISBURY 1 AXLE SALISBURY 1 AXLE		SET1041 SET1041 18790/18720 18690/18620			06/81 - 09/84 06/81 - 09/84 06/81 - 09/84 06/81 - 09/84
<b>DAILY 35 - 10</b>						
		32208 30305	SET1041 SET1041 SET1098 SET1041			Exc. Iveco check control Exc. Iveco check control Iveco check control Iveco check control
<b>DAILY 35 - 10 TURBODAILY</b>						
			SET1041 SET1041			9 01/96-12/99 9 01/96-12/99
<b>DAILY 35 - 12 TURBODAILY</b>						
		SET1108 SET1106	SET1041 SET1041			- 02/96 - 02/96 [03/96 - ] ABS [-12/99] [03/96 - ] ABS [-12/99]
<b>DAILY 40 - 8</b>						
	IVECO IVECO SALISBURY SALISBURY SALISBURY 1 AXLE SALISBURY 1 AXLE SALISBURY 2 AXLE SALISBURY 2 AXLE IVECO IVECO	SET1011 30305 32208 30305 SET201 18690/18620	18790/18720 18690/18620 387A/382 SET201 SET1041 SET1041			10/77 - 05/79 10/77 - 05/79 06/79 - 02/96 06/79 - 02/96 06/81 - 09/84 06/81 - 09/84 06/81 - 09/84 06/81 - 09/84 10/77 - 06/81 10/77 - 06/81 - 02/96 - 02/96
<b>DAILY 40 - 8 HEAVY DUTY</b>						
		32208 30305	SET1041 SET1041			
<b>DAILY 45 - 10</b>						
		SET1108 SET1106	SET1041 SET1041 SET1098 SET1041			Ratio 5.62/1 Ratio 5.62/1 Exc. Ratio 5.62/1 Exc. Ratio 5.62/1
<b>DAILY 49 - 10</b>						
		SET1108 SET1106				

●●●●●●●●●● APPLICATION LISTINGS - LIGHT COMMERCIAL VEHICLE















					
<b>IVECO</b>					
<b>DAILY 49 - 10 ...</b>					
			SET1041 SET1041 SET1098 SET1041		
<b>DAILY 49 - 12 TURBODAILY</b>					
		SET1108 SET1106	SET1098 SET1041		- 02/96 - 02/96 - 02/96 - 02/96
<b>DAILY 59 - 12 TURBODAILY</b>					
			SET1293 SET1293		
<b>DUCATO I 10</b>					
		XAA32010X XAA32010X XAA32010X XAA32010X	XAA32008X 32006X XAA32008X 32006X		- Ch. 604496 [1982 - 1989] - Ch. 604496 [1982 - 1989] Ch. 604497 - [1989 - 1993] Ch. 604497 - [1989 - 1993] - Ch. 278757 [1982 - 1986] - Ch. 278757 [1982 - 1986] Ch. 278758 - [1986 - 1993] Ch. 278758 - [1986 - 1993]
<b>DUCATO 13</b>					
		XAA32010X XAA32010X	XAA32008X 32006X XAA32008X 32006X		1982 - 1986 1982 - 1986 - Ch. 278757 [1982 - 1986] - Ch. 278757 [1982 - 1986] Ch. 278758 - [1986 - 1993] Ch. 278758 - [1986 - 1993]
<b>DUCATO I 14</b>					
		XAA32010X XAA32010X XAA32010X XAA32010X	XAA32008X 32006X		- Ch. 604496 [1986 - 1989] - Ch. 604496 [1986 - 1989] Ch. 604497 - [1989 - 1993] Ch. 604497 - [1989 - 1993] 1986 - 1993 1986 - 1993
<b>DUCATO I MAXI 18</b>					
		XAA32010X XAA32010X XAA32010X XAA32010X	XAA33108 32206		- Ch. 604496 [1986 - 1989] - Ch. 604496 [1986 - 1989] Ch. 604497 - [1989 - 1993] Ch. 604497 - [1989 - 1993]
<b>DUCATO II 10 [4X2]</b>					
		XAA32010X XAA32010X	XAA32008X 32006X		

A









# APPLICATION LISTINGS - LIGHT COMMERCIAL VEHICLE ●●●●●●●●●●

A

						
<b>IVECO</b>						
<b>DUCATO II 10 [4X4]</b>						
		XAA32010X XAA32010X		XAA32010X XAA32010X		
<b>DUCATO II 14 [4X2]</b>						
		XAA32010X XAA32010X		XAA32008X 32006X		
<b>DUCATO II 14 [4X4]</b>						
		XAA32010X XAA32010X		XAA32010X XAA32010X		
<b>DUCATO II 18 [4X2]</b>						
		JXC25678CA/Y32011X JXC25678CA/Y32011X		XAA33108 32206		
<b>DUCATO II 18 [4X4]</b>						
		JXC25678CA/Y32011X JXC25678CA/Y32011X		XAA32010X XAA32010X		
<b>GRINTA 28 - 8</b>						
	SALISBURY AXLE 1 SALISBURY AXLE 1	SET1011 30305 32208 30305		18790/18720 18690/18620		10/77 - 05/79 10/77 - 05/79 06/79 - 06/81 06/79 - 06/81 10/77 - 06/81 10/77 - 06/81
<b>GRINTA 30 - 8</b>						
	IVECO IVECO SALISBURY SALISBURY SALISBURY AXLE 1 SALISBURY AXLE 1 IVECO IVECO	SET1011 30305 32208 30305 32208 30305 SET201 18690/18620		SET201 18690/18620 SET1041 SET1041		10/77 - 05/79 10/77 - 05/79 06/79 - 06/81 06/79 - 06/81 06/81 - 09/84 06/81 - 09/84 06/81 - 09/84 06/81 - 09/84 10/77 - 06/81 10/77 - 06/81 06/81 - 09/84 06/81 - 09/84
<b>GRINTA 30 - 9</b>						
	IVECO IVECO	32208 30305				06/81 - 09/84 06/81 - 09/84

# APPLICATION LISTINGS - LIGHT COMMERCIAL VEHICLE













					
<b>IVECO</b>					
<b>GRINTA 30 - 9 ...</b>					
	SALISBURY SALISBURY SALISBURY AXLE 1 SALISBURY AXLE 1	SET201 18690/18620	18790/18720 18690/18620	I O I O	06/81 - 09/84 06/81 - 09/84 06/81 - 09/84 06/81 - 09/84
<b>GRINTA 32 - 8</b>					
	IVECO IVECO SALISBURY AXLE 1 SALISBURY AXLE 1	SET1011 30305 32208 30305	SET201 18690/18620	I O I O I O	10/77 - 05/79 10/77 - 05/79 06/79 - 06/81 06/79 - 06/81 10/77 - 06/81 10/77 - 06/81
<b>GRINTA 35 - 8</b>					
	IVECO IVECO SALISBURY SALISBURY SALISBURY AXLE 1 SALISBURY AXLE 1 SALISBURY AXLE 1 SALISBURY AXLE 1	SET1011 30305 32208 30305 32208 30305 SET201 18690/18620	18790/18720 18690/18620 18790/18720 18690/18620	I O I O I O I O I O	10/77 - 05/79 10/77 - 05/79 06/79 - 06/81 06/79 - 06/81 06/81 - 09/84 06/81 - 09/84 06/81 - 09/84 06/81 - 09/84 10/77 - 06/81 10/77 - 06/81 06/81 - 09/84 06/81 - 09/84
<b>GRINTA 35 - 9</b>					
	IVECO IVECO IVECO IVECO SALISBURY SALISBURY	32208 30305	SET1041 SET1041 18790/18720 18690/18620	I O I O I O	06/81 - 09/84 06/81 - 09/84 06/81 - 09/84 06/81 - 09/84 06/81 - 09/84 06/81 - 09/84
<b>GRINTA 40 - 8</b>					
	IVECO IVECO SALISBURY SALISBURY SALISBURY 2 AXLE SALISBURY 2 AXLE SALISBURY 1 AXLE SALISBURY 1 AXLE	SET1011 30305 32208 30305 32208 30305 SET201 18690/18620	387A/382 SET201 18790/18720 18690/18620	I O I O I O I O I O	10/77 - 05/79 10/77 - 05/79 06/79 - 06/81 06/79 - 06/81 06/81 - 09/84 06/81 - 09/84 06/81 - 09/84 06/81 - 09/84 10/77 - 06/81 10/77 - 06/81 06/81 - 09/84 06/81 - 09/84
<b>GRINTA SERIES S [30 - 9 / 35 - 8 / 35 - 10 / 40 - 8 / 40 - 10]</b>					
	IVECO IVECO IVECO IVECO	32208 30305	SET1041 SET1041	I O I O	10/84 - 1988 10/84 - 1988 10/84 - 1988 10/84 - 1988

A

















# APPLICATION LISTINGS - LIGHT COMMERCIAL VEHICLE

A

									
									
<b>IVECO</b>									
<b>GRINTA SERIES S TURBO [45 - 10 / 49 - 10]</b>									
			SET1108 SET1106		SET1098 SET1040			03/85 - 1988 03/85 - 1988 03/85 - 1988 03/85 - 1988	
<b>PEUGEOT</b>									
<b>BOXER</b>									
	1000 / 1400 KG 1000 / 1400 KG 1800 KG 1800 KG 1000 / 1400 KG 1000 / 1400 KG 1800 KG 1800 KG	XAA32010X XAA32010X JXC25678CA/Y32011X JXC25678CA/Y32011X		XAA32008X 32006X XAA33108 32206					
<b>J 5</b>									
	1000 / 1300 KG 1000 / 1300 KG 1000 / 1300 KG 1000 / 1300 KG 1400 KG 1400 KG 1400 KG 1400 KG 180 / 1800 KG 180 / 1800 KG 180 / 1800 KG 180 / 1800 KG 1000 / 1300 KG 1000 / 1300 KG 1000 / 1300 KG 1000 / 1300 KG 1400 KG 1400 KG 180 / 1800 KG 180 / 1800 KG	XAA32010X XAA32010X XAA32010X XAA32010X XAA32010X XAA32010X XAA32010X XAA32010X XAA32010X XAA32010X XAA32010X XAA32010X XAA32010X XAA32010X XAA32010X XAA32010X XAA32010X XAA32010X XAA32010X XAA32010X		XAA32008X 32006X XAA32008X 32006X XAA32008X 32006X XAA33108 32206			- Ch. 604496 - Ch. 604496 Ch. 604497 - Ch. 604497 - - Ch. 604496 - Ch. 604496 Ch. 604497 - Ch. 604497 - - Ch. 604496 - Ch. 604496 Ch. 604497 - Ch. 604497 - - Ch. 604496 - Ch. 604496 Ch. 604497 - Ch. 604497 - - Ch. 244300 - Ch. 244300 Ch. 244301 - Ch. 244301 -		
<b>RENAULT RVI</b>									
<b>MASCOTT 3.5 T - 5.5 T</b>									
	RIGID RIGID		SET1096 SET1106						
<b>MASCOTT 5.5 T - 6.5 T</b>									
	RIGID RIGID P669		SET1096 SET1106		SET1042				













































# APPLICATION LISTINGS - LIGHT COMMERCIAL VEHICLE

					
<b>MERCEDES - BENZ</b>					
<b>307 D</b>					
	VL 1/3 - 2.1 VL 1/3 - 2.1 VL 1/3 - 2.1 VL 1/3 - 2.1	2789/2720 SET226 SET1097 33205			- Ch. 48630 - Ch. 48630 Ch. 48631 - Ch. 48631 -
<b>308</b>					
	VL 1/3 - 2.1 VL 1/3 - 2.1 VL 1/3 - 2.1 VL 1/3 - 2.1	2789/2720 SET226 SET1097 33205			- Ch. 48630 - Ch. 48630 Ch. 48631 - Ch. 48631 -
<b>308 D</b>					
	VL 1/3 - 2.1 VL 1/3 - 2.1 VL 1/3 - 2.1 VL 1/3 - 2.1	2789/2720 SET226 SET1097 33205			- Ch. 48630 - Ch. 48630 Ch. 48631 - Ch. 48631 -
<b>309</b>					
	VL 1/3 - 2.1 VL 1/3 - 2.1 VL 1/3 - 2.1 VL 1/3 - 2.1	2789/2720 SET226 SET1097 33205			- Ch. 48630 - Ch. 48630 Ch. 48631 - Ch. 48631 -
<b>309 D</b>					
	VL 1/3 - 2.1 VL 1/3 - 2.1 VL 1/3 - 2.1 VL 1/3 - 2.1	2789/2720 SET226 SET1097 33205			- Ch. 48630 - Ch. 48630 Ch. 48631 - Ch. 48631 -
<b>310</b>					
	VL 1/3 - 2.1 VL 1/3 - 2.1 VL 1/3 - 2.1 VL 1/3 - 2.1	2789/2720 SET226 SET1097 33205			- Ch. 48630 - Ch. 48630 Ch. 48631 - Ch. 48631 -
<b>310 D</b>					
	VL 1/3 - 2.1 VL 1/3 - 2.1 VL 1/3 - 2.1 VL 1/3 - 2.1	2789/2720 SET226 SET1097 33205			- Ch. 48630 - Ch. 48630 Ch. 48631 - Ch. 48631 -
<b>312</b>					
	VL 1/3 - 2.1 VL 1/3 - 2.1 VL 1/3 - 2.1 VL 1/3 - 2.1	2789/2720 SET226 SET1097 33205			- Ch. 48630 - Ch. 48630 Ch. 48631 - Ch. 48631 -
<b>314</b>					
	VL 1/3 - 2.1 VL 1/3 - 2.1 VL 1/3 - 2.1 VL 1/3 - 2.1	2789/2720 SET226 SET1097 33205			- Ch. 48630 - Ch. 48630 Ch. 48631 - Ch. 48631 -









# APPLICATION LISTINGS - LIGHT COMMERCIAL VEHICLE

A

				 			
<b>MERCEDES - BENZ</b>							
<b>315</b>							
	VL 1/3 - 2.1	2789/2720				- Ch. 48630	
	VL 1/3 - 2.1	SET226				- Ch. 48630	
	VL 1/3 - 2.1	SET1097				Ch. 48631 -	
	VL 1/3 - 2.1	33205				Ch. 48631 -	
<b>406</b>							
	VL 1/3 - 2.1	2789/2720				- Ch. 48630	
	VL 1/3 - 2.1	SET226				- Ch. 48630	
	VL 1/3 - 2.1	SET1097				Ch. 48631 -	
	VL 1/3 - 2.1	33205				Ch. 48631 -	
	VL 1/4 - 1.6	SET1072				-Ch.17768 Diesel, -Ch.1288 Petrol	
	VL 1/4 - 1.6	32207				-Ch.17768 Diesel, -Ch.1288 Petrol	
	VL 1/4 - 1.6	2789/2720				Ch.17769 - Ch.17814 Diesel,	
	VL 1/4 - 1.6	SET226				Ch.1289 - Ch.4706 Petrol	
	VL 1/4 - 1.6	SET1097				Ch.17769 - Ch.17814 Diesel,	
	VL 1/4 - 1.6	33205				Ch.1289 - Ch.4706 Petrol	
	HL 03 - 3.3		SET1041			Ch.17815- Diesel, Ch.4707- Petrol	
	HL 03 - 3.3		32210			Ch.17815- Diesel, Ch.4707- Petrol	
	HL 1/2 - 3.3		SET1060				
	HL 1/2 - 3.3		32210				
<b>406 D</b>							
	VL 1/3 - 2.1	2789/2720				- Ch. 48630	
	VL 1/3 - 2.1	SET226				- Ch. 48630	
	VL 1/3 - 2.1	SET1097				Ch. 48631 -	
	VL 1/3 - 2.1	33205				Ch. 48631 -	
	VL 1/4 - 1.6	SET1072				-Ch.17768 Diesel, -Ch.1288 Petrol	
	VL 1/4 - 1.6	32207				-Ch.17768 Diesel, -Ch.1288 Petrol	
	VL 1/4 - 1.6	2789/2720				Ch.17769 - Ch.17814 Diesel,	
	VL 1/4 - 1.6	SET226				Ch.1289 - Ch.4706 Petrol	
	VL 1/4 - 1.6	SET1097				Ch.17769 - Ch.17814 Diesel,	
	VL 1/4 - 1.6	33205				Ch.1289 - Ch.4706 Petrol	
	HL 03 - 3.3		SET1041			Ch.17815- Diesel, Ch.4707- Petrol	
	HL 03 - 3.3		32210			Ch.17815- Diesel, Ch.4707- Petrol	
	HL 1/2 - 3.3		SET1060				
	HL 1/2 - 3.3		32210				
<b>407</b>							
	VL 1/3 - 2.1	2789/2720				- Ch. 48630	
	VL 1/3 - 2.1	SET226				- Ch. 48630	
	VL 1/3 - 2.1	SET1097				Ch. 48631 -	
	VL 1/3 - 2.1	33205				Ch. 48631 -	
	VL 1/4 - 1.6	SET1072				-Ch.17768 Diesel, -Ch.1288 Petrol	
	VL 1/4 - 1.6	32207				-Ch.17768 Diesel, -Ch.1288 Petrol	
	VL 1/4 - 1.6	2789/2720				Ch.17769 - Ch.17814 Diesel,	
	VL 1/4 - 1.6	SET226				Ch.1289 - Ch.4706 Petrol	
	VL 1/4 - 1.6	SET1097				Ch.17769 - Ch.17814 Diesel,	
	VL 1/4 - 1.6	33205				Ch.1289 - Ch.4706 Petrol	
	VL 1/4 - 1.6		SET1041			Ch.17815- Diesel, Ch.4707- Petrol	
	VL 1/4 - 1.6		32210			Ch.17815- Diesel, Ch.4707- Petrol	









# APPLICATION LISTINGS - LIGHT COMMERCIAL VEHICLE

					
<b>MERCEDES - BENZ</b>					
<b>407 ...</b>					
	HL 03 - 3.3 HL 03 - 3.3 HL 1/2 - 3.3 HL 1/2 - 3.3		SET1041 32210 SET1060 32210	I O I O	
<b>407 D</b>					
	VL 1/3 - 2.1 VL 1/3 - 2.1 VL 1/3 - 2.1 VL 1/3 - 2.1 VL 1/4 - 1.6 VL 1/4 - 1.6 VL 1/4 - 1.6  VL 1/4 - 1.6  VL 1/4 - 1.6 VL 1/4 - 1.6 HL 03 - 3.3 HL 03 - 3.3 HL 1/2 - 3.3 HL 1/2 - 3.3	2789/2720 SET226 SET1097 33205 SET1072 32207 2789/2720  SET226  SET1097 33205	SET1041 32210 SET1060 32210	I O I O I O I  O  I O I O I O	- Ch. 48630 - Ch. 48630 Ch. 48631 - Ch. 48631 - -Ch.17768 Diesel, -Ch.1288 Petrol -Ch.17768 Diesel, -Ch.1288 Petrol Ch.17769 - Ch.17814 Diesel, Ch.1289 - Ch.4706 Petrol Ch.17769 - Ch.17814 Diesel, Ch.1289 - Ch.4706 Petrol Ch.17815- Diesel, Ch.4707- Petrol Ch.17815- Diesel, Ch.4707- Petrol
<b>408</b>					
	VL 1/3 - 2.1 VL 1/3 - 2.1 VL 1/3 - 2.1 VL 1/3 - 2.1 VL 1/4 - 1.6 VL 1/4 - 1.6 VL 1/4 - 1.6  VL 1/4 - 1.6  VL 1/4 - 1.6 VL 1/4 - 1.6 HL 03 - 3.3 HL 03 - 3.3 HL 1/2 - 3.3 HL 1/2 - 3.3	2789/2720 SET226 SET1097 33205 SET1072 32207 2789/2720  SET226  SET1097 33205	SET1041 32210 SET1060 32210	I O I O I O I  O  I O I O I O	- Ch. 48630 - Ch. 48630 Ch. 48631 - Ch. 48631 - -Ch.17768 Diesel, -Ch.1288 Petrol -Ch.17768 Diesel, -Ch.1288 Petrol Ch.17769 - Ch.17814 Diesel, Ch.1289 - Ch.4706 Petrol Ch.17769 - Ch.17814 Diesel, Ch.1289 - Ch.4706 Petrol Ch.17815- Diesel, Ch.4707- Petrol Ch.17815- Diesel, Ch.4707- Petrol
<b>408 D</b>					
	VL 1/3 - 2.1 VL 1/3 - 2.1 VL 1/3 - 2.1 VL 1/3 - 2.1 VL 1/4 - 1.6 VL 1/4 - 1.6 VL 1/4 - 1.6  VL 1/4 - 1.6  VL 1/4 - 1.6 VL 1/4 - 1.6	2789/2720 SET226 SET1097 33205 SET1072 32207 2789/2720  SET226  SET1097 33205		I O I O I O I  O  I O	- Ch. 48630 - Ch. 48630 Ch. 48631 - Ch. 48631 - -Ch.17768 Diesel, -Ch.1288 Petrol -Ch.17768 Diesel, -Ch.1288 Petrol Ch.17769 - Ch.17814 Diesel, Ch.1289 - Ch.4706 Petrol Ch.17769 - Ch.17814 Diesel, Ch.1289 - Ch.4706 Petrol Ch.17815- Diesel, Ch.4707- Petrol Ch.17815- Diesel, Ch.4707- Petrol









# APPLICATION LISTINGS - LIGHT COMMERCIAL VEHICLE

A

									
									
<b>MERCEDES - BENZ</b>									
<b>408 D ...</b>									
	HL 03 - 3.3 HL 03 - 3.3 HL 1/2 - 3.3 HL 1/2 - 3.3				SET1041 32210 SET1060 32210				
<b>408 G</b>									
	VL 1/3 - 2.1 VL 1/3 - 2.1 VL 1/3 - 2.1 VL 1/3 - 2.1 VL 1/4 - 1.6 VL 1/4 - 1.6 VL 1/4 - 1.6  VL 1/4 - 1.6  VL 1/4 - 1.6 VL 1/4 - 1.6 HL 03 - 3.3 HL 03 - 3.3 HL 1/2 - 3.3 HL 1/2 - 3.3	2789/2720 SET226 SET1097 33205 SET1072 32207 2789/2720  SET226  SET1097 33205			SET1041 32210 SET1060 32210				- Ch. 48630 - Ch. 48630 Ch. 48631 - Ch. 48631 - -Ch.17768 Diesel, -Ch.1288 Petrol -Ch.17768 Diesel, -Ch.1288 Petrol Ch.17769 - Ch.17814 Diesel, Ch.1289 - Ch.4706 Petrol Ch.17769 - Ch.17814 Diesel, Ch.1289 - Ch.4706 Petrol Ch.17815- Diesel, Ch.4707- Petrol Ch.17815- Diesel, Ch.4707- Petrol
<b>409</b>									
	VL 1/3 - 2.1 VL 1/3 - 2.1 VL 1/3 - 2.1 VL 1/3 - 2.1 VL 1/4 - 1.6 VL 1/4 - 1.6 VL 1/4 - 1.6  VL 1/4 - 1.6  VL 1/4 - 1.6 VL 1/4 - 1.6 HL 03 - 3.3 HL 03 - 3.3 HL 1/2 - 3.3 HL 1/2 - 3.3	2789/2720 SET226 SET1097 33205 SET1072 32207 2789/2720  SET226  SET1097 33205			SET1041 32210 SET1060 32210				- Ch. 48630 - Ch. 48630 Ch. 48631 - Ch. 48631 - -Ch.17768 Diesel, -Ch.1288 Petrol -Ch.17768 Diesel, -Ch.1288 Petrol Ch.17769 - Ch.17814 Diesel, Ch.1289 - Ch.4706 Petrol Ch.17769 - Ch.17814 Diesel, Ch.1289 - Ch.4706 Petrol Ch.17815- Diesel, Ch.4707- Petrol Ch.17815- Diesel, Ch.4707- Petrol
<b>409 D</b>									
	VL 1/3 - 2.1 VL 1/3 - 2.1 VL 1/3 - 2.1 VL 1/3 - 2.1 VL 1/4 - 1.6 VL 1/4 - 1.6 VL 1/4 - 1.6  VL 1/4 - 1.6  VL 1/4 - 1.6 VL 1/4 - 1.6	2789/2720 SET226 SET1097 33205 SET1072 32207 2789/2720  SET226  SET1097 33205							- Ch. 48630 - Ch. 48630 Ch. 48631 - Ch. 48631 - -Ch.17768 Diesel, -Ch.1288 Petrol -Ch.17768 Diesel, -Ch.1288 Petrol Ch.17769 - Ch.17814 Diesel, Ch.1289 - Ch.4706 Petrol Ch.17769 - Ch.17814 Diesel, Ch.1289 - Ch.4706 Petrol Ch.17815- Diesel, Ch.4707- Petrol Ch.17815- Diesel, Ch.4707- Petrol

# APPLICATION LISTINGS - LIGHT COMMERCIAL VEHICLE

					
<b>MERCEDES - BENZ</b>					
<b>409 D ...</b>					
	HL 03 - 3.3 HL 03 - 3.3 HL 1/2 - 3.3 HL 1/2 - 3.3		SET1041 32210 SET1060 32210	I O I O	
<b>410</b>					
	VL 1/3 - 2.1 VL 1/3 - 2.1 VL 1/3 - 2.1 VL 1/3 - 2.1 VL 1/4 - 1.6 VL 1/4 - 1.6 VL 1/4 - 1.6  VL 1/4 - 1.6  VL 1/4 - 1.6 VL 1/4 - 1.6 HL 03 - 3.3 HL 03 - 3.3 HL 1/2 - 3.3 HL 1/2 - 3.3	2789/2720 SET226 SET1097 33205 SET1072 32207 2789/2720  SET226  SET1097 33205	SET1041 32210 SET1060 32210	I O I O I O I  O  I O I O I O	- Ch. 48630 - Ch. 48630 Ch. 48631 - Ch. 48631 - -Ch.17768 Diesel, -Ch.1288 Petrol -Ch.17768 Diesel, -Ch.1288 Petrol Ch.17769 - Ch.17814 Diesel, Ch.1289 - Ch.4706 Petrol Ch.17769 - Ch.17814 Diesel, Ch.1289 - Ch.4706 Petrol Ch.17815- Diesel, Ch.4707- Petrol Ch.17815- Diesel, Ch.4707- Petrol
<b>410 D</b>					
	VL 1/3 - 2.1 VL 1/3 - 2.1 VL 1/3 - 2.1 VL 1/3 - 2.1 VL 1/4 - 1.6 VL 1/4 - 1.6 VL 1/4 - 1.6  VL 1/4 - 1.6  VL 1/4 - 1.6 VL 1/4 - 1.6 HL 03 - 3.3 HL 03 - 3.3 HL 1/2 - 3.3 HL 1/2 - 3.3	2789/2720 SET226 SET1097 33205 SET1072 32207 2789/2720  SET226  SET1097 33205	SET1041 32210 SET1060 32210	I O I O I O I  O  I O I O I O	- Ch. 48630 - Ch. 48630 Ch. 48631 - Ch. 48631 - -Ch.17768 Diesel, -Ch.1288 Petrol -Ch.17768 Diesel, -Ch.1288 Petrol Ch.17769 - Ch.17814 Diesel, Ch.1289 - Ch.4706 Petrol Ch.17769 - Ch.17814 Diesel, Ch.1289 - Ch.4706 Petrol Ch.17815- Diesel, Ch.4707- Petrol Ch.17815- Diesel, Ch.4707- Petrol
<b>412</b>					
	VL 1/3 - 2.1 VL 1/3 - 2.1 VL 1/3 - 2.1 VL 1/3 - 2.1 VL 1/4 - 1.6 VL 1/4 - 1.6 VL 1/4 - 1.6  VL 1/4 - 1.6  VL 1/4 - 1.6 VL 1/4 - 1.6	2789/2720 SET226 SET1097 33205 SET1072 32207 2789/2720  SET226  SET1097 33205		I O I O I O I  O  I O	- Ch. 48630 - Ch. 48630 Ch. 48631 - Ch. 48631 - -Ch.17768 Diesel, -Ch.1288 Petrol -Ch.17768 Diesel, -Ch.1288 Petrol Ch.17769 - Ch.17814 Diesel, Ch.1289 - Ch.4706 Petrol Ch.17769 - Ch.17814 Diesel, Ch.1289 - Ch.4706 Petrol Ch.17815- Diesel, Ch.4707- Petrol Ch.17815- Diesel, Ch.4707- Petrol





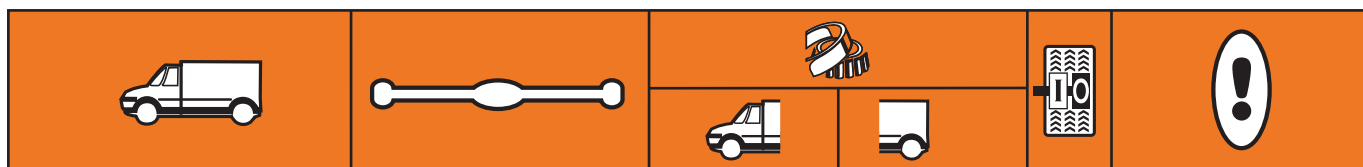

**MERCEDES - BENZ**

**500 SERIES ...**

	HL 0/7 - 3.2		SET1041	I	
	HL 0/7 - 3.2		32210	O	
	HL 1/2 - 3.3		SET1060	I	
	HL 1/2 - 3.3		32210	O	
	HL 1/3 - 4.5		SET98	I	
	HL 1/3 - 4.5		SET272	O	
	HL 2/5 - 4.5		SET98	I	
	HL 2/5 - 4.5		SET272	O	
	HL 2/9 - 4.7		SET98	I	
	HL 2/9 - 4.7		SET272	O	





B

APPLICATIONS LISTINGS - FINAL DRIVE

**B**

**APPLICATIONS LISTINGS - FINAL DRIVE**





# APPLICATION LISTINGS - FINAL DRIVE



		<b>Application</b>	
<b>DAF</b>			
<b>1132</b>			
	FORWARD AXLE FORWARD AXLE	DIFFERENTIAL-RIGHT DIFFERENTIAL-LEFT	XAA32018X-90KA1 XAA32018X-90KA1
<b>1332</b>			
	FORWARD AXLE FORWARD AXLE	DIFFERENTIAL-RIGHT DIFFERENTIAL-LEFT	XAA32018X-90KA1 XAA32018X-90KA1
<b>1354</b>			
	FORWARD AXLE FORWARD AXLE FORWARD AXLE FORWARD AXLE	PINION-TAIL PINION-HEAD DIFFERENTIAL-RIGHT DIFFERENTIAL-LEFT	3977-99401 52401-99401 497A-99401 47687-99401
<b>1:5.86 - [1305-L0387660]</b>			
	FORWARD AXLE	PINION-HEAD	H715332-99401
<b>1:5.86 - [1305-L1243591]</b>			
	FORWARD AXLE FORWARD AXLE	DIFFERENTIAL-RIGHT DIFFERENTIAL-LEFT	9278-99402 9278-99402
<b>2255 - [1305-0295214]</b>			
	FORWARD AXLE	PINION-TAIL	78214-99401
<b>2255 - [1305-88503]</b>			
	FORWARD AXLE	PINION-HEAD	78225-99401
<b>IVECO</b>			
<b>4517</b>			
	REAR AXLE REAR AXLE	PINION-TAIL PINION-HEAD	HM804848-99401 SET240
<b>4521</b>			
	REAR AXLE REAR AXLE REAR AXLE REAR AXLE	PINION-TAIL PINION-HEAD DIFFERENTIAL-RIGHT DIFFERENTIAL-LEFT	HM803149-99404 SET240 SET1207 SET1207
<b>ARM 125</b>			
	REAR AXLE REAR AXLE REAR AXLE REAR AXLE	PINION-TAIL PINION-HEAD DIFFERENTIAL-RIGHT DIFFERENTIAL-LEFT	HM804846-99401 55206C-99404 34306-99401 3994/JM511910
<b>ARM 145</b>			
	REAR AXLE REAR AXLE REAR AXLE REAR AXLE	PINION-TAIL PINION-HEAD DIFFERENTIAL-RIGHT DIFFERENTIAL-LEFT	HM804846-99401 55206C-99404 JM716649-99401 3994/JM511910

**B**

# APPLICATION LISTINGS - FINAL DRIVE

B



		<b>Application</b>	
<b>IVECO</b>			
<b>ARM 160</b>			
	REAR AXLE REAR AXLE REAR AXLE	PINION-HEAD DIFFERENTIAL-RIGHT DIFFERENTIAL-LEFT INPUT-SHAFT OUTPUT-SHAFT	H715343-99402 52400-99401 SET403 HM813843/HM813810 JLM714149/JLM714110
<b>ARM 186</b>			
	REAR AXLE REAR AXLE REAR AXLE REAR AXLE	PINION-HEAD PINION-TAIL DIFFERENTIAL-RIGHT DIFFERENTIAL-LEFT	H715334-9X021 9278-99401 64450-99401 JHM720249
<b>MS16 [ARM 167]</b>			
	REAR AXLE	PINION PAC-HEAD/TAIL	NP622975-907A5
<b>MS17 [ARM177]</b>			
	REAR AXLE REAR AXLE	PINION PAC-HEAD/TAIL DIFFERENTIAL-LEFT	SET1265 JHM720249
<b>MAN</b>			
<b>F120/3 - [RATIO:5.57]</b>			
	FORWARD AXLE FORWARD AXLE	PINION-TAIL PINION-HEAD	HM803149-99404 HM804843-99401
<b>HY-13110 [RATIO 37:7/8/9/10/11/12]</b>			
	FORWARD AXLE	DIFFERENTIAL-LEFT	32024X-9X064
<b>VW 6,8 T [RATIO:4.44,39:7,4.87,5:570]</b>			
	FORWARD AXLE	PINION-HEAD	SET1192
<b>RENAULT RVI</b>			
<b>569-10</b>			
		DIFFERENTIAL-RIGHT DIFFERENTIAL-LEFT	SET1210 SET1210
<b>669-01</b>			
		PINION-TAIL PINION-HEAD	XBA32308B-90NA1 SET240
<b>669-02</b>			
		PINION-TAIL PINION-HEAD	XBA32308B-90NA1 SET240
<b>669-04</b>			
		PINION-TAIL PINION-HEAD	XBA32308B-90NA1 SET240
<b>ARM 177</b>			
	REAR AXLE REAR AXLE REAR AXLE	PINION PAC-HEAD/TAIL DIFFERENTIAL-RIGHT DIFFERENTIAL-LEFT	SET1265 SET1244 32021X-9X026



		<b>Application</b>	
<b>RENAULT RVI</b>			
<b>C9 HR</b>			
		DIFFERENTIAL-RIGHT DIFFERENTIAL-LEFT	32019X-9X026 32021X-9X026
<b>P1332-21</b>			
		PINION-TAIL	HM813839/HM813810
<b>P1332-22</b>			
		PINION-TAIL	HM813839/HM813810
<b>P1332-52</b>			
		PINION-TAIL	HM813839/HM813810
<b>P1332-54</b>			
		PINION-TAIL	HM813839/HM813810
<b>P1332-C</b>			
		PINION-TAIL	HM813839/HM813810
<b>P1332-E51</b>			
		PINION-TAIL	HM813839/HM813810
<b>P1332-C1</b>			
		PINION-TAIL	HM813839/HM813810
<b>PMA1341</b>			
		PINION-TAIL	H715347-99402
<b>PMA1341-02</b>			
		PINION-TAIL	H715347-99402
<b>PMA1841B</b>			
		PINION-TAIL	H715347-99402
<b>PMA1845B</b>			
		PINION-TAIL DIFFERENTIAL-RIGHT DIFFERENTIAL-LEFT	H715347-99402 33212-90KA1 33212-90KA1
<b>SOMA 95</b>			
		PINION-TAIL	HM804842-99402
<b>SCANIA</b>			
<b>RETARDER - GZ TRANSMISSION [GR900/905, GRS900/905]</b>			
		MAIN-FRONT	SET238
<b>RB652</b>			
	FORWARD AXLE FORWARD AXLE	INPUT-FRONT INPUT-REAR	SET320 SET320

B

# APPLICATION LISTINGS - FINAL DRIVE

B

		<b>Application</b>	
<b>SCANIA</b>			
<b>RBP830</b>			
	FORWARD AXLE FORWARD AXLE FORWARD AXLE FORWARD AXLE	INPUT-FRONT INPUT-REAR OUTPUT-FRONT OUTPUT-REAR	SET320 SET320 SET320 SET320
<b>RBP831</b>			
	FORWARD AXLE FORWARD AXLE FORWARD AXLE FORWARD AXLE	INPUT-FRONT INPUT-REAR OUTPUT-FRONT OUTPUT-REAR	SET320 SET320 SET320 SET320
<b>RP831</b>			
		PINION-TAIL	H913842-9X021
<b>RP830</b>			
		PINION-TAIL	H913842-9X021
<b>R780</b>			
		PINION-TAIL	H913842-9X021
<b>VOLVO</b>			
<b>EV21</b>			
		DIFFERENTIAL-RIGHT DIFFERENTIAL-LEFT	33212-90KA1 33212-90KA1
<b>EV35</b>			
		PINION-TAIL PINION-HEAD	HM804843-99401 HM813840-99401
<b>EV45</b>			
		PINION-HEAD	HM911245-99401
<b>EV71</b>			
		DIFFERENTIAL-RIGHT	32017X-90KA1
<b>EV72</b>			
		DIFFERENTIAL-LEFT	32017X-90KA1
<b>EV76</b>			
		PINION-HEAD	H715332-99401
<b>EV85B</b>			
		PINION-TAIL PINION-HEAD	H913842-9X021 H913842-9X021
<b>EV82FR</b>			
		PINION-HEAD	H913842-9X021

		<b>Application</b>	
<b>VOLVO</b>			
<b>MS15 [MT150]</b>			
	FORWARD REAR	DIFFERENTIAL-RIGHT PINION PAC-HEAD/TAIL DIFFERENTIAL-RIGHT INPUT-SHAFT OUTPUT-SHAFT	SET1244 NP895655-90NA1 SET1244 SET82 SET82
<b>MS17 [ARM 177]</b>			
	REAR AXLE REAR AXLE REAR AXLE	PINION PAC-HEAD/TAIL DIFFERENTIAL-RIGHT DIFFERENTIAL-LEFT	SET1265 SET1244 32021X-9X026

B



# PRODUCT INFORMATION

# C

C

## **Product information**

<i>Numerical Listings</i> . . . . .	<i>p. C3</i>
<i>Dimensional Guide</i> . . . . .	<i>p. C15</i>
<i>Cross-Reference Guide</i> . . . . .	<i>p. C17</i>
<i>Fitting Instructions</i> . . . . .	<i>p. C27</i>
<i>Bearing Damage Analysis</i> . . . . .	<i>p. C31</i>
<i>Maintenance Tools</i> . . . . .	<i>p. C35</i>

PRODUCT INFORMATION

c



<b>397XA/394XS</b> DODGE	60.00x109.99x23.75mm	<b>665X/653X</b> RENAULT RVI	85.00x150.00x41.28mm
<b>455/453X</b> NISSAN	50.80x104.78x30.16mm	<b>681A/672</b> DAF	92.08x168.28x41.28mm
<b>478XA/473XS</b> BEDFORD	64.99x119.98x32.75mm	<b>748S/742</b> LEYLAND	76.20x150.09x44.45mm
<b>482/472</b> BEDFORD	69.85x120.00x29.79mm	<b>749A/742</b> DAF VOLVO	82.55x150.09x44.45mm
<b>482A/472</b> BEDFORD	69.85x120.00x29.79mm	<b>1988/1922</b> DODGE	28.58x57.15x19.85mm
<b>495/493</b> DAF	82.55x136.53x30.16mm	<b>2580/2520</b> BEDFORD	31.75x66.42x25.40mm
<b>495A/493</b> FORD	76.20x136.53x30.16mm	<b>2789/2720</b> MERCEDES-BENZ	39.69x76.20x23.77mm
<b>497A-99401</b> DAF	85.73x133.35x30.16mm	<b>3490/3420</b> BEDFORD BRISTOL DAF DODGE LEYLAND	38.10x79.38x29.37mm
<b>528R/522</b> BEDFORD	47.63x101.60x34.93mm	<b>3585/3525</b> DAF DODGE FORD LEYLAND	41.28x87.31x30.16mm
<b>558/552A</b> BRISTOL LEYLAND	60.33x123.83x38.10mm	<b>3778/3720</b> DODGE	47.63x93.26x30.16mm
<b>560/552A</b> AWD BEDFORD NISSAN	66.68x123.83x38.10mm	<b>3782/3720</b> DAF	44.45x93.26x30.16mm
<b>566/563</b> BRISTOL	69.85x127.00x36.51mm	<b>3880/3820</b> NISSAN	41.28x85.73x30.16mm
<b>567X/563</b> DODGE LEYLAND	73.03x127.00x36.51mm	<b>3977-99401</b> DAF	60.00x112.71x30.16mm
<b>575S/572</b> BEDFORD	76.20x139.99x36.51mm	<b>3977X/3921XA</b> BEDFORD	59.99x109.99x29.75mm
<b>578X/572</b> DODGE	79.99x139.99x36.51mm	<b>3982/3920</b> DENNIS LEYLAND	63.50x112.71x30.16mm
<b>582/572</b> VOLVO		<b>3994/JM511910</b> IVECO	
<b>594/593X</b> RENAULT RVI	95.25x150.00x35.99mm	<b>5583/5535</b> DAF	60.33x122.24x43.66mm
<b>598/592A</b> MERCEDES-BENZ	92.08x152.40x39.69mm		
<b>598X/592A</b> LEYLAND	92.08x152.40x39.69mm		

# NUMERICAL LISTINGS

**6379/6321** 65.09x131.76x53.98mm

DAF

**6386/6320** 66.68x135.76x53.98mm

IVECO  
VOLVO

**6461A/6420** 76.20x149.23x53.98mm

NISSAN

**6581X/6535** 90.00x161.93x53.98mm

IVECO

**07087X/07210X** 22.23x50.80x15.01mm

DAF

**9278-99401** 68.26x161.93x49.21mm

IVECO

**9278-99402** 68.26x161.93x49.21mm

DAF

**18690/18620** 46.04x79.38x17.46mm

DAF  
IVECO

**25580/25520** 44.45x82.93x23.81mm

DODGE

**30205** 25.00x52.00x16.25mm

NISSAN  
RENAULT RVI

**30213** 65.00x120.00x24.75mm

DODGE

**30215** 75.00x130.00x27.25mm

IVECO

**30311** 55.00x120.00x31.50mm

IVECO  
SAF

**30313** 65.00x140.00x36.00mm

SAF

**32006X** 30.00x55.00x17.00mm

CITROEN  
IVECO  
PEUGEOT

**32008X** 40.00x68.00x19.00mm

RENAULT RVI

**32017X-90KA1** 85.00x130.00x29.00mm

VOLVO

**32018X** 90.00x140.00x32.00mm

IVECO  
MAN  
MERCEDES-BENZ  
RENAULT RVI

**32019X-9X026**

RENAULT RVI

**32021X-9X026**

RENAULT RVI  
VOLVO

**32024X-9X064** 120.00x180.00x38.00mm

MAN

**32206** 30.00x62.00x21.25mm

CITROEN  
DAF  
IVECO  
MERCEDES-BENZ  
PEUGEOT  
RENAULT RVI  
VOLVO

**32207** 35.00x72.00x24.25mm

MAN  
MERCEDES-BENZ  
RENAULT RVI  
VOLVO

**32208** 40.00x80.00x24.75mm

GIGANT [SAE]  
IVECO  
MAN  
MERCEDES-BENZ  
RENAULT RVI  
VOLVO

**32210** 50.00x90.00x24.75mm

GIGANT [SAE]  
MAN  
MERCEDES-BENZ  
RENAULT RVI  
VOLVO

**32222** 110.00x200.00x56.00mm

BPW

**32305** 25.00x62.00x25.25mm

RENAULT RVI

**32309B** 45.00x100.00x38.25mm

DAF  
RENAULT RVI

**32310**

SCHMITZ CARGOBULL

**32311**

SCHMITZ CARGOBULL

**33013** 65.00x100.00x27.00mm

RENAULT RVI  
VOLVO

C

<b>33017</b> MERCEDES-BENZ	85.00x130.00x36.00mm	<b>64432/64708</b> RENAULT RVI	109.98x177.80x41.28mm
<b>33205</b> MERCEDES-BENZ RENAULT RVI	25.00x52.00x22.00mm	<b>64450-99401</b> IVECO	114.30x177.80x41.28mm
<b>33206</b> IVECO MAN RENAULT RVI	30.00x62.00x25.00mm	<b>74550/74850</b> FODEN	139.70x215.90x47.63mm
<b>33210</b> DAF MAN MERCEDES-BENZ RENAULT RVI	50.00x90.00x32.00mm	<b>78214-99401</b> DAF	53.98x140.03x36.51mm
<b>33211</b> IVECO MERCEDES-BENZ RENAULT RVI SAF	55.00x100.00x35.00mm	<b>78225-99401</b> DAF	57.15x140.03x36.51mm
<b>33212-90KA1</b> RENAULT RVI VOLVO	60.00x110.00x29.75mm	<b>EK50005</b> VOLVO	
<b>34306-99401</b> IVECO	77.79x121.44x24.61mm	<b>EK50022</b> DAF	
<b>39586/39528</b> MERCEDES-BENZ	64.99x119.99x32.75mm	<b>EK50024</b> MAN	
<b>42686/42624</b> BEDFORD	74.99x129.98x33.25mm	<b>EK50029</b> MERCEDES-BENZ	
<b>42687/42620</b> VOLVO		<b>EK50036</b> MERCEDES-BENZ	
<b>47490/47420</b> MERCEDES-BENZ	71.44x120.00x32.55mm	<b>EK50037</b> MERCEDES-BENZ	
<b>47687/47620</b> DAF	82.55x133.35x33.34mm	<b>EK50042</b> RENAULT RVI	
<b>49175/49368</b> BRISTOL	44.45x93.66x31.75mm	<b>EK50044</b> VOLVO	
<b>52400-99401</b> IVECO	101.60x157.16x36.51mm	<b>EK50045</b> ARVINMERITOR [ROR]	
<b>52401-99401</b> DAF	101.60x157.16x36.51mm	<b>EK50046</b> ARVINMERITOR [ROR]	
<b>55206C-99404</b> IVECO	53.39x111.13x30.16mm	<b>H212749/H212710</b> DODGE LEYLAND	65.99x124.00x41.50mm
<b>56426/56650</b> ERF	107.95x165.10x36.51mm	<b>H414245X/H414210</b> BEDFORD BRISTOL NISSAN	68.26x136.53x41.28mm
		<b>H414249/H414210</b> ERF	71.44x136.53x41.28mm
		<b>H715332-99401</b> DAF VOLVO	60.33x136.53x46.04mm

# NUMERICAL LISTINGS

**H715334-9X021** 61.91x136.53x46.04mm

IVECO

**H715343-99402** 68.26x136.53x46.04mm

IVECO

**H715347-99402** 69.99x136.53x46.04mm

RENAULT RVI

**H913842-9X021** 61.91x146.05x41.28mm

SCANIA  
VOLVO

**HM212044/HM212010** 60.33x122.24x38.10mm

NISSAN

**HM212044/HM212011** 60.33x122.33x38.10mm

FODEN  
LEYLAND  
VOLVO

**HM218248Z/HM218210**

SCANIA  
VOLVO

**HM220149Z/HM220110Z**

SCANIA  
VOLVO

**HM515745/HM515716** 76.20x142.14x44.45mm

DODGE

**HM801346X/HM801310** 38.10x82.55x29.37mm

DENNIS

**HM803149-99404** 44.45x88.90x30.16mm

IVECO  
MAN

**HM804842-99402** 44.45x95.25x30.16mm

RENAULT RVI

**HM804843-99401** 44.45x95.25x30.16mm

MAN  
VOLVO

**HM804846-99401** 47.63x95.25x30.16mm

IVECO

**HM804848-99401** 48.41x95.25x30.16mm

IVECO

**HM813839/HM813810** 59.99x127.00x36.51mm

RENAULT RVI

**HM813840/HM813810** 55.56x127.00x36.51mm

VOLVO

**HM813843/HM813810**

IVECO

**JH211749/JH211710** 65.00x120.00x39.00mm

RENAULT RVI  
SAURER

**JHM720249**

IVECO

**JLM714149/JLM714110**

IVECO  
RENAULT RVI

**JM718149A/JM718110** 90.00x145.00x35.00mm

TRAILOR

**JXC18439CA/439DA**

IVECO

**JXC25381CD-90UB6**

ALEXANDER DENNIS

**JXC25381CH/381DC** 70.00x130.00x43.00mm

IVECO

**JXC25678CA/Y32011X** 55.00x90.00x23.00mm

CITROEN  
IVECO  
PEUGEOT

**L68149/L68110** 34.99x59.13x15.88mm

DAF

**LM48548/LM48510** 34.93x65.09x18.03mm

FORD

**LM67048/LM67010** 31.75x59.13x15.88mm

NISSAN

**NP622975-907A5**

IVECO

**NP895655-90NA1**

VOLVO

**NP958644-9X048** 35.00x62.00x18.00mm

FORD

**SET82**

VOLVO

**SET103** 66.68x112.71x30.16mm

DAF  
DODGE  
FORD  
IVECO  
MERCEDES-BENZ

**SET105** 73.03x117.48x30.16mm

DENNIS  
FORD

<b>SET109</b>	<b>95.25x168.28x41.28mm</b>	<b>SET238</b>	<b>40.00x85.00x33.00mm</b>
BRISTOL DAF LEYLAND RENAULT RVI VOLVO		SCANIA	
<b>SET110</b>	<b>65.09x135.76x53.98mm</b>	<b>SET240</b>	<b>50.00x105.00x32.00mm</b>
ERF LEYLAND		IVECO RENAULT RVI	
<b>SET111</b>	<b>127.00mm</b>	<b>SET262</b>	<b>82.55x125.41x25.40mm</b>
TATRA		DAF NISSAN	
<b>SET113</b>	<b>75.99x132.00x39.00mm</b>	<b>SET276</b>	<b>57.15x112.71x30.16mm</b>
FODEN FORD LEYLAND SAF VOLVO		VOLVO	
<b>SET114</b>	<b>65.99x124.00x41.50mm</b>	<b>SET278</b>	<b>57.15x112.71x30.16mm</b>
BRISTOL DAF ERF FODEN SEDDON ATKINSON YORK		BEDFORD DAF DODGE FORD LEYLAND	
<b>SET115</b>	<b>75.00x145.00x51.00mm</b>	<b>SET289</b>	<b>95.25x157.16x36.51mm</b>
IVECO MERCEDES-BENZ		RENAULT RVI	
<b>SET123</b>	<b>50.80x93.26x30.16mm</b>	<b>SET315</b>	<b>50.00x90.00x28.00mm</b>
BEDFORD BRISTOL DODGE FORD		BRISTOL FODEN SAURER VOLVO	
<b>SET201</b>	<b>50.80x88.90x20.64mm</b>	<b>SET317</b>	<b>99.98x156.98x42.00mm</b>
IVECO		DODGE IVECO LEYLAND MERCEDES-BENZ SEDDON ATKINSON YORK	
<b>SET210</b>	<b>44.45x101.60x34.93mm</b>	<b>SET320</b>	<b>60.00x95.00x24.00mm</b>
DODGE ERF LEYLAND		SCANIA	
<b>SET212</b>	<b>50.80x107.95x36.51mm</b>	<b>SET323</b>	<b>110.00x180.00x47.00mm</b>
VOLVO		SAURER	
<b>SET216</b>	<b>95.25x152.40x39.69mm</b>	<b>SET325</b>	<b>75.00x120.00x31.00mm</b>
FORD LEYLAND SEDDON ATKINSON VOLVO		DAF IVECO LEYLAND MERCEDES-BENZ	
<b>SET226</b>	<b>45.62x82.93x23.81mm</b>	<b>SET339</b>	<b>VOLVO</b>
FORD MERCEDES-BENZ NISSAN			
<b>SET230</b>	<b>38.10x76.20x23.77mm</b>	<b>SET349</b>	<b>73.03x127.00x36.51mm</b>
DODGE		IVECO RENAULT RVI	
		<b>SET361</b>	<b>85.00x130.00x30.00mm</b>
		IVECO SEDDON ATKINSON	
		<b>SET365</b>	<b>66.68x110.00x22.00mm</b>
		NISSAN	

# NUMERICAL LISTINGS

**SET401** 82.55x139.99x36.51mm

AWD  
BEDFORD  
FODEN  
FORD  
LEYLAND  
MERCEDES-BENZ  
NISSAN  
RENAULT RVI  
SEDDON ATKINSON  
VOLVO

**SET403** 95.25x152.40x39.69mm

BEDFORD  
DENNIS  
DODGE  
ERF  
FODEN  
IVECO  
LEYLAND  
SEDDON ATKINSON

**SET404** 92.08x152.40x39.69mm

AWD  
DAF  
FODEN

**SET405** 82.55x146.05x41.28mm

DAF  
FODEN  
SEDDON ATKINSON  
VOLVO

**SET408** 66.68x112.71x30.16mm

FORD  
MAN  
VOLVO

**SET411** 82.55x133.35x33.34mm

FORD

**SET412** 63.50x122.24x38.10mm

DODGE  
SEDDON ATKINSON

**SET414** 89.98x146.98x40.00mm

ARVINMERITOR [ROR]  
BRISTOL  
DODGE  
LEYLAND  
RENAULT RVI  
SAF  
SCHMITZ CARGOBULL  
YORK

**SET415** 88.90x152.40x39.69mm

FRUEHAUF  
MONTENEGRO

**SET416** 57.15x104.78x30.16mm

DAF

**SET508** 101.60x168.28x41.28mm

DAF

**SET928** 69.85x120.00x32.55mm

IVECO

**SET929** 88.90x161.93x47.63mm

LEYLAND

**SET1009** 34.93x73.03x23.81mm

DODGE

**SET1011** 38.10x76.20x20.64mm

IVECO

**SET1015** 30.00x62.00x17.25mm

NISSAN

**SET1018** 45.00x85.00x20.75mm

NISSAN

**SET1019** 50.00x90.00x21.75mm

NISSAN

**SET1021** 70.00x150.00x38.00mm

MERCEDES-BENZ

**SET1022** 80.00x140.00x28.25mm

IVECO  
KÄSSBOHRER

**SET1024** 90.00x160.00x32.50mm

IVECO  
KÄSSBOHRER  
MAN  
NISSAN

**SET1025** 100.00x180.00x37.00mm

MAN  
MERCEDES-BENZ

**SET1026** 105.00x190.00x39.00mm

IVECO  
TATRA

**SET1030** 35.00x80.00x22.75mm

DODGE  
IVECO  
SAF

**SET1031** 45.00x100.00x27.25mm

IVECO  
SAF

**SET1032** 60.00x130.00x33.50mm

IVECO  
SAF

**SET1040** 50.00x80.00x20.00mm

IVECO

C

**SET1041** 55.00x90.00x23.00mm

IVECO  
MERCEDES-BENZ  
RENAULT RVI

**SET1042** 60.00x95.00x23.00mm

DODGE  
MERCEDES-BENZ  
RENAULT RVI

**SET1043** 65.00x100.00x23.00mm

RENAULT RVI

**SET1044** 70.00x110.00x25.00mm

IVECO  
MERCEDES-BENZ  
RENAULT RVI

**SET1045** 75.00x115.00x25.00mm

IVECO  
MAN  
RENAULT RVI

**SET1046** 80.00x125.00x29.00mm

DAF  
MERCEDES-BENZ

**SET1047** 85.00x130.00x29.00mm

BEDFORD  
IVECO  
MAN  
MERCEDES-BENZ  
RENAULT RVI

**SET1049** 95.00x145.00x32.00mm

DAF  
MAN  
MERCEDES-BENZ  
RENAULT RVI

**SET1050** 100.00x150.00x32.00mm

MERCEDES-BENZ

**SET1051** 105.00x160.00x35.00mm

IVECO  
KÄSSBOHRER-SETRA  
MERCEDES-BENZ

**SET1052** 110.00x170.00x38.00mm

KÄSSBOHRER-SETRA

**SET1053** 120.00x180.00x38.00mm

IVECO

**SET1058** 45.00x85.00x24.75mm

LEYLAND  
VOLVO

**SET1060** 55.00x100.00x26.75mm

GIGANT [SAE]  
IVECO  
MERCEDES-BENZ  
RENAULT RVI  
VOLVO

**SET1061** 60.00x110.00x29.75mm

BEDFORD  
GIGANT [SAE]

**SET1062** 65.00x120.00x32.75mm

SAF  
SCHMITZ CARGOBULL

**SET1063** 70.00x125.00x33.25mm

GIGANT [SAE]  
IVECO

**SET1064** 75.00x130.00x33.25mm

IVECO  
MAN  
MERCEDES-BENZ  
SCANIA

**SET1065** 80.00x140.00x35.25mm

BEDFORD  
GIGANT [SAE]  
KÄSSBOHRER  
MERCEDES-BENZ  
SCANIA

**SET1066** 85.00x150.00x38.50mm

HINO  
IVECO  
MERCEDES-BENZ  
MONTENEGRO  
RENAULT RVI  
SEDDON ATKINSON

**SET1067** 90.00x160.00x42.50mm

ARVINMERITOR [ROR]  
BEDFORD  
GIGANT [SAE]  
HINO  
KÄSSBOHRER  
SAF  
SCANIA  
SEDDON ATKINSON

**SET1068** 95.00x170.00x45.50mm

BPW  
IVECO  
NISSAN  
SCANIA  
SEDDON ATKINSON  
VOLVO

# NUMERICAL LISTINGS

**SET1069** 100.00x180.00x49.00mm

ARVINMERITOR [ROR]  
GIGANT [SAE]  
IVECO

**SET1070** 105.00x190.00x53.00mm

IVECO  
SAF

**SET1071** 120.00x215.00x61.50mm

BPW

**SET1072** 20.00x52.00x22.25mm

MERCEDES-BENZ

**SET1074** 30.00x72.00x28.75mm

MERCEDES-BENZ

**SET1075** 35.00x80.00x32.75mm

IVECO  
NISSAN

**SET1076** 40.00x90.00x35.25mm

SCANIA  
VOLVO

**SET1078** 45.00x100.00x38.25mm

DAF  
IVECO  
KÄSSBOHRER-SETRA  
MAN  
RENAULT RVI  
SCANIA

**SET1079** 50.00x110.00x42.25mm

BPW  
DAF  
GIGANT [SAE]  
HINO  
IVECO  
MAN  
MERCEDES-BENZ  
NISSAN

**SET1080** 55.00x120.00x45.50mm

DAF  
IVECO  
MERCEDES-BENZ  
MERCEDES-BENZ DISCOS  
SCANIA

**SET1081** 60.00x130.00x48.50mm

IVECO  
MERCEDES-BENZ  
SAF  
SCANIA  
VOLVO

**SET1082** 65.00x140.00x51.00mm

HINO

**SET1083** 70.00x150.00x54.00mm

BPW  
MERCEDES-BENZ  
SAF

**SET1084** 80.00x170.00x61.50mm

BPW

**SET1085** 120.00x165.00x29.00mm

SAF

**SET1086** 55.00x90.00x27.00mm

MERCEDES-BENZ

**SET1087** 60.00x100.00x30.00mm

MERCEDES-BENZ  
RENAULT RVI  
VOLVO

**SET1088** 70.00x110.00x31.00mm

MERCEDES-BENZ  
RENAULT RVI  
VOLVO

**SET1089** 75.00x115.00x31.00mm

MAN  
MERCEDES-BENZ  
NISSAN  
RENAULT RVI  
VOLVO

**SET1090** 90.00x150.00x45.00mm

BPW  
GIGANT [SAE]  
IVECO  
RENAULT RVI  
SCHMITZ CARGOBULL  
VOLVO

**SET1091** 95.00x145.00x39.00mm

BEDFORD  
DAF  
IVECO  
MAN  
MERCEDES-BENZ  
SEDDON ATKINSON

**SET1092** 100.00x150.00x39.00mm

MERCEDES-BENZ  
SCHMITZ CARGOBULL

**SET1093** 105.00x160.00x43.00mm

IVECO  
MAN  
MERCEDES-BENZ

**SET1094** 110.00x170.00x47.00mm

MAN  
MERCEDES-BENZ  
VOLVO



**SET1096** 120.00x180.00x48.00mm

GIGANT [SAE]  
RENAULT RVI

**SET1097** 45.00x80.00x26.00mm

MERCEDES-BENZ  
RENAULT RVI

**SET1098** 55.00x95.00x30.00mm

IVECO  
MERCEDES-BENZ

**SET1100** 65.00x110.00x34.00mm

IVECO  
MERCEDES-BENZ  
SAF

**SET1102** 80.00x130.00x37.00mm

BPW  
GIGANT [SAE]  
MERCEDES-BENZ  
SCHMITZ CARGOBULL

**SET1103** 85.00x140.00x41.00mm

MERCEDES-BENZ  
RENAULT RVI

**SET1107** 35.00x72.00x28.00mm

IVECO  
RENAULT RVI  
SAF  
VOLVO

**SET1108** 40.00x80.00x32.00mm

GIGANT [SAE]  
IVECO  
MERCEDES-BENZ  
RENAULT RVI  
VOLVO

**SET1109** 45.00x85.00x32.00mm

DAF  
IVECO  
LEYLAND  
MAN  
MERCEDES-BENZ  
RENAULT RVI  
SAF

**SET1112** 60.00x110.00x38.00mm

IVECO  
RENAULT RVI  
SAF

**SET1113** 65.00x120.00x41.00mm

ARVINMERITOR [ROR]  
BEDFORD  
BPW  
GIGANT [SAE]  
IVECO  
MERCEDES-BENZ  
RENAULT RVI  
SAF  
SCHMITZ CARGOBULL  
VOLVO  
YORK

**SET1114** 70.00x125.00x41.00mm

MERCEDES-BENZ  
RENAULT RVI

**SET1115** 75.00x130.00x41.00mm

BPW  
MERCEDES-BENZ  
SCANIA

**SET1116** 80.00x140.00x46.00mm

RENAULT RVI

**SET1117** 85.00x150.00x49.00mm

IVECO  
MERCEDES-BENZ  
MERCEDES-BENZ DISCOS  
SCHMITZ CARGOBULL  
VOLVO

**SET1118** 53.98x95.25x27.78mm

MERCEDES-BENZ

**SET1123** 57.15x98.43x21.00mm

IVECO

**SET1125** 66.68x110.00x22.00mm

DAF

**SET1129** 82.55x133.35x33.34mm

DAF  
VOLVO

**SET1130** 136.53x190.50x39.69mm

DAF

**SET1132** 101.60x157.16x36.51mm

ERF  
FODEN  
LEYLAND

**SET1135** 76.20x139.99x36.51mm

BEDFORD  
DENNIS  
FODEN  
SEDDON ATKINSON

# NUMERICAL LISTINGS

**SET1137** 82.55x139.70x36.51mm

BEDFORD  
BRISTOL  
ERF  
LEYLAND

**SET1138** 95.25x147.64x35.72mm

DAF

**SET1139** 57.15x120.65x41.28mm

BRISTOL  
DENNIS  
ERF  
LEYLAND

**SET1146** 66.68x136.53x41.28mm

DODGE  
LEYLAND

**SET1151** 45.99x91.00x32.00mm

ERF  
FODEN  
SEDDON ATKINSON

**SET1152** 66.68x122.24x38.10mm

IVECO

**SET1163** 40.00x85.00x33.00mm

SCANIA

**SET1165** 70.00x130.00x43.00mm

SCANIA  
VOLVO

**SET1166** 95.00x160.00x46.00mm

RENAULT RVI

**SET1169** 100.00x160.00x41.00mm

RENAULT RVI  
TATRA

**SET1176** 55.00x95.00x29.00mm

VOLVO

**SET1177**

DAF

**SET1178** 65.00x110.00x28.00mm

DAF  
LEYLAND  
RENAULT RVI

**SET1179** 80.00x130.00x35.00mm

TRAILOR

**SET1184** 110.00x165.00x35.00mm

SAURER

**SET1191** 90.00x150.00x42.00mm

RENAULT RVI

**SET1192** 55.00x115.00x34.00mm

MAN

**SET1195** 45.00x85.00x32.00mm

IVECO

**SET1199** 45.00x75.00x20.00mm

IVECO

**SET1201** 55.00x100.00x35.00mm

IVECO

**SET1207** 75.00x115.00x25.00mm

IVECO

**SET1208** 70.00x120.00x37.00mm

IVECO

**SET1210** 70.00x120.00x37.00mm

RENAULT RVI

**SET1231** 68.00x127.00x115.00mm

SCANIA

**SET1237** 82.00x140.00x110.00mm

BREDAMENARINIBUS  
IVECO

**SET1242** 90.00x160.00x125.00mm

DENNIS  
IVECO

**SET1244** 101.60x160.00x35.00mm

RENAULT RVI  
VOLVO

**SET1254**

ARVINMERITOR [ROR]

**SET1257** 90.00x160.00x125.00mm

IRISBUS

**SET1262** 78.00x130.00x90.00mm

DAF

**SET1263** 78.00x130.00x90.00mm

IVECO

**SET1265**

IVECO  
RENAULT RVI  
VOLVO

**SET1285** 90.00x140.00x32.00mm

DAF

**SET1286** 85.00x150.00x38.50mm

IVECO

**SET1287** 95.00x170.00x45.50mm

IVECO

**SET1293** 77.79x121.44x24.61mm

IVECO

**SET1299**

FRUEHAUF  
SMB

**SET1300**

DAF  
MAN

**SET1301**

KÄSSBOHRER-SETRA  
MERCEDES-BENZ

**SET1303**

DAF

**SET1306**

DAF  
MAN  
MERCEDES-BENZ

**SET1307**

MAN  
MERCEDES-BENZ

**SET1309**

MERCEDES-BENZ

**U497/U460L**

44.99x79.98x24.00mm

DAF

**XAA32008X**

40.00mm

CITROEN  
IVECO  
PEUGEOT

**XAA32010X**

50.00mm

CITROEN  
IVECO  
PEUGEOT

**XAA32011XM-90NM5** 55.00x90.00x70.00mm

FORD

**XAA33108**

40.00x75.00x26.00mm

CITROEN  
IVECO  
PEUGEOT

**XAA33212**

60.00x110.00x38.00mm

IVECO

**XBA32308B-90NA1**

40.00x90.00x35.25mm

RENAULT RVI

**XC8640CD/HM220110**

SCANIA

**XGA32021X**

106.00x160.00x35.00mm

MAN  
MERCEDES-BENZ

**NOTES**





**C**

Lined writing area consisting of multiple horizontal orange lines.





# DIMENSIONAL GUIDE

Ø INT.	Ø EXT.	width	 REF
20.00	52.00	22.25	SET1072
22.23	50.80	15.01	07087X/07210X
22.23	52.39	19.37	SET226
25.00	52.00	16.25	30205
25.00	52.00	22.00	33205
25.00	62.00	18.25	30305
25.00	62.00	25.25	32305
28.58	57.15	19.85	1988/1922
30.00	55.00	17.00	32006X
30.00	62.00	17.25	SET1015
30.00	62.00	21.25	32206
30.00	62.00	25.00	SET1106
30.00	72.00	28.75	SET1074
30.00	72.00	28.75	SET1074
31.75	59.13	15.88	LM67048/LM67010
31.75	66.42	25.40	2580/2520
34.93	65.09	18.03	LM48548/ LM48510
34.93	73.03	23.81	SET1009
34.99	59.13	15.88	L68149/L68110
35.00	62.00	18.00	NP958644-9X048
35.00	72.00	24.25	32207
35.00	72.00	28.00	SET1107
35.00	80.00	22.75	SET1030
35.00	80.00	32.75	SET1075
38.10	76.20	20.64	SET1011
38.10	76.20	23.77	SET230
38.10	79.38	29.37	SET1119
38.10	82.55	29.37	HM801346X/ HM801310
39.69	76.20	23.77	2789/2720
40.00			XAA32008X
40.00			XAA33108
40.00	68.00	18.99	32008X
40.00	75.00	26.00	SET1096
40.00	75.00	26.00	XAA33108
40.00	80.00	24.75	32208
40.00	80.00	32.00	SET1108
40.00	80.00	32.00	SET1108
40.00	80.00	32.00	SET1108
40.00	85.00	33.00	SET238
40.00	85.00	33.00	SET1163
40.00	90.00	35.25	SET1076
40.00	90.00	35.25	XBA32308B-90NA1
41.28	85.73	30.16	3880/3820
41.28	87.31	30.16	SET102
44.45	82.93	23.81	25580/25520
44.45	88.90	30.16	HM803149-99404
44.45	93.26	30.16	3782/3720
44.45	93.66	31.75	49175/49368
44.45	95.25	30.16	HM804842-99402
44.45	95.25	30.16	HM804843-99401
44.45	101.60	34.93	SET210
44.45	120.65	41.28	615/612
44.99	79.98	24.00	U497/U460L
45.00	75.00	20.00	SET1199
45.00	80.00	26.00	SET1097
45.00	85.00	20.75	SET1018
45.00	85.00	24.75	SET1058
45.00	85.00	32.00	SET1109
45.00	85.00	32.00	SET1109
45.00	85.00	32.00	SET1195
45.00	100.00	27.25	SET1031
45.00	100.00	38.25	SET1078
45.00	100.00	38.25	32309B
45.62	82.93	23.81	SET54
45.99	91.00	32.00	SET1151
46.04	79.38	17.46	18690/18620
47.63	93.26	30.16	3778/3720
47.63	95.25	30.16	HM804846-99401
47.63	101.60	34.93	528R/522

Ø INT.	Ø EXT.	width	 REF
48.42	95.25	30.16	HM804848-99401
50.00			XAA32010X
50.00	80.00	20.00	SET1040
50.00	90.00	21.75	SET1019
50.00	90.00	24.75	32210
50.00	90.00	28.00	SET315
50.00	90.00	32.00	SET1110
50.00	105.00	32.00	SET240
50.00	110.00	42.25	SET1079
50.80	82.93	21.59	LM104949-99401
50.80	85.00	17.46	18790/18720
50.80	88.90	20.64	SET201
50.80	93.27	30.16	SET123
50.80	104.78	30.16	455/453X
50.80	107.95	36.51	SET212
53.39	111.13	30.16	55206C-99404
53.98	95.25	27.78	SET272
53.98	130.18	36.51	HM911242-99401
53.98	140.03	36.51	78214-99401
55.00			JXC25678CA/ Y32011X
55.00	90.00	23.00	SET1041
55.00	90.00	23.00	JXC25678CA/ Y32011X
55.00	90.00	27.00	SET1086
55.00	90.00	70.00	XAA32011XM- 90NM5
55.00	95.00	29.00	SET1176
55.00	95.00	30.00	SET1098
55.00	95.00	30.00	SET1098
55.00	100.00	22.75	30211
55.00	100.00	22.75	30211M
55.00	100.00	26.75	SET1060
55.00	100.00	35.00	SET1111
55.00	100.00	35.00	SET1201
55.00	115.00	34.00	SET1192
55.00	120.00	31.50	30311
55.00	120.00	45.50	SET1080
55.57	127.00	36.51	HM813840/ HM813810
57.15	98.43	21.00	SET1123
57.15	104.78	30.16	SET416
57.15	112.71	30.16	SET276
57.15	112.71	30.16	SET278
57.15	120.65	41.28	SET1139
57.15	140.03	36.51	78225-99401
59.99	109.99	29.75	3977X/3921XA
59.99	127.00	36.51	HM813839/ HM813810
60.00	95.00	23.00	SET1042
60.00	95.00	24.00	SET320
60.00	95.00	27.00	SET1087
60.00	100.00	30.00	SET1099
60.00	109.99	23.75	397XA/394XS
60.00	110.00	29.75	SET1061
60.00	110.00	29.75	33212-90KA1
60.00	110.00	38.00	SET1112
60.00	110.00	38.00	XAA33212
60.00	112.712	30.16	3977-99401
60.00	130.00	33.50	SET1032
60.00	130.00	48.50	SET1081
60.00	130.00	48.50	32312M
60.33	122.24	38.10	HM212044/ HM212010
60.33	122.24	43.66	5583/5535
60.33	122.33	38.10	HM212044/ HM212011
60.33	123.83	38.10	558/552A
60.33	136.53	46.04	H715332-99401
61.92	127.00	36.51	HM813843-99401
61.92	136.53	46.04	H715334-9X021

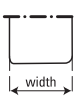
Ø INT.	Ø EXT.	width	 REF
61.92	146.05	41.28	H913842-9X021
63.50	112.71	30.16	SET103
63.50	122.24	38.10	SET412
64.99	119.99	32.75	39586/39528
64.99	119.98	32.75	478XA/473XS
65.00	100.00	23.00	SET1043
65.00	100.00	27.00	33013
65.00	110.00	28.00	SET1178
65.00	110.00	34.00	SET1100
65.00	120.00	24.75	30213
65.00	120.00	32.75	SET1062
65.00	120.00	39.00	JH211749/ JH211710
65.00	120.00	41.00	SET1113
65.00	140.00	36.00	SET1033
65.00	140.00	51.00	SET1082
65.09	131.76	53.98	6379/6321
65.09	135.76	53.98	SET110
65.99	124.00	41.50	SET114
65.99	124.00	41.50	H212749/ H212710
66.68	110.00	22.00	SET365
66.68	110.00	22.00	SET1125
66.68	110.00	29.14	3994-99406
66.68	112.71	30.16	SET98
66.68	112.71	30.16	SET408
66.68	122.24	38.10	SET1152
66.68	123.83	38.10	560/552A
66.68	135.76	53.98	6386/6320
66.68	136.53	41.28	SET1146
68.00	127.00	115.00	SET1231
68.26	136.53	41.28	H414245X/ H414210
68.26	136.53	46.04	H715343-99402
68.26	161.93	49.21	9278-99401
68.26	161.93	49.21	9278-99402
69.85	120.00	29.79	482/472
69.85	120.00	29.79	482A/472
69.85	120.00	32.55	47487/47420
69.85	127.00	36.51	566/563
69.99	136.53	46.04	H715347-99402
70.00	110.00	25.00	SET1044
70.00	110.00	31.00	SET1088
70.00	120.00	37.00	SET1208
70.00	120.00	37.00	SET1210
70.00	125.00	33.25	SET1063
70.00	125.00	41.00	SET1114
70.00	130.00	43.00	SET1165
70.00	130.00	43.00	JXC25381CH/ 381DC
70.00	150.00	38.00	SET1034
70.00	150.00	54.00	SET1083
71.44	120.00	32.55	SET928
71.44	136.53	41.28	H414249/ H414210
73.03	117.48	30.16	SET105
73.03	127.00	36.51	SET349
73.03	127.00	36.51	567X/563
74.99	129.98	33.25	42686/42624
75.00	115.00	25.00	SET1045
75.00	115.00	25.00	JLM714149- 99401
75.00	115.00	25.00	JLM714149/ JLM714110
75.00	115.00	25.00	SET1207
75.00	115.00	25.00	SET1207
75.00	115.00	31.00	SET1089
75.00	115.00	31.00	SET1089
75.00	120.00	31.00	SET325
75.00	125.00	37.00	SET1101
75.00	130.00	27.25	30215

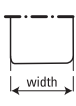
# DIMENSIONAL GUIDE

∅ INT.	∅ EXT.	 width	 REF	∅ INT.	∅ EXT.	 width	 REF
75.00	130.00	33.25	SET1064	92.08	168.28	41.28	681A/672
75.00	130.00	41.00	SET1115	95.00	145.00	32.00	SET1049
75.00	145.00	51.00	SET115	95.00	145.00	39.00	SET1091
75.99	132.00	39.00	SET113	95.00	145.00	39.00	SET1091
76.20	133.35	33.34	SET1128	95.00	160.00	46.00	SET1166
76.20	136.53	30.16	495A/493	95.00	170.00	45.50	SET1068
76.20	139.99	36.51	SET1135	95.00	170.00	45.50	SET1287
76.20	139.99	36.51	575S/572	95.25	147.64	35.72	SET1138
76.20	142.14	44.45	HM515745/ HM515716	95.25	150.00	35.99	594/593X
76.20	149.23	53.98	6461A/6420	95.25	152.40	39.69	SET216
76.20	150.09	44.45	748S/742	95.25	152.40	39.69	SET403
77.79	121.44	24.61	34306-99401	95.25	152.40	39.69	594A-99401
77.79	121.44	24.61	SET1293	95.25	157.16	36.51	52375/52618
78.00	130.00	90.00	SET1262	95.25	168.28	41.28	SET109
78.00	130.00	90.00	SET1263	99.98	156.98	42.00	SET317
79.99	139.99	36.51	578X/572	99.98	156.98	42.00	HM220149Z/ HM220110Z
80.00	125.00	29.00	SET1046	99.98	156.98	42.00	XC8640CD/ HM220110
80.00	130.00	35.00	SET1179	100.00	150.00	32.00	SET1050
80.00	130.00	37.00	SET1102	100.00	150.00	39.00	SET1092
80.00	140.00	28.25	SET1022	100.00	160.00	41.00	SET1169
80.00	140.00	35.25	SET1065	100.00	160.00	41.00	JHM720249- 9X026
80.00	140.00	35.25	SET1065	100.00	180.00	37.00	SET1025
80.00	140.00	45.99	SET1116	100.00	180.00	37.00	SET1025
80.00	170.00	61.50	SET1084	100.00	180.00	49.00	SET1069
82.00	140.00	36.51	SET1254	101.60	157.16	36.51	SET289
82.00	140.00	110.00	SET1237	101.60	157.16	36.51	52400-99401
82.55	125.41	25.40	SET262	101.60	157.16	36.51	SET1132
82.55	133.35	33.34	SET411	101.60	157.16	36.51	52401-99401
82.55	133.35	33.34	SET1129	101.60	160.00	35.00	SET1244
82.55	133.35	33.34	47687-99401	101.60	168.28	41.28	SET508
82.55	136.53	30.16	495/493	101.60	168.28	41.28	SET508
82.55	139.70	36.51	SET1137	105.00	160.00	35.00	SET1051
82.55	139.99	36.51	SET401	105.00	160.00	43.00	SET1093
82.55	146.05	41.28	SET405	105.00	190.00	39.00	SET1026
82.55	150.09	44.45	749A/742	105.00	190.00	53.00	SET1070
85.00	130.00	29.00	SET1047	106.00	160.00	35.00	XGA32021X
85.00	130.00	29.00	32017X-90KA1	106.00	160.00	35.00	XGA32021X
85.00	130.00	30.00	SET361	106.00	160.00	35.00	56426/56650
85.00	130.00	30.00	SET361	107.95	165.10	36.51	64432/64708
85.00	130.00	36.00	33017	109.98	177.80	41.28	64432/64708
85.00	140.00	41.00	SET1103	110.00	165.00	35.00	SET1184
85.00	150.00	38.50	SET1066	110.00	170.00	38.00	SET1052
85.00	150.00	38.50	SET1286	110.00	170.00	47.00	SET1094
85.00	150.00	41.28	665X/653X	110.00	180.00	47.00	SET1094
85.00	150.00	49.00	SET1117	110.00	180.00	47.00	SET323
85.00	150.00	49.00	SET1117	110.00	200.00	56.00	32222
85.73	133.35	30.16	497A-99401	114.30	177.80	41.28	64450-99401
88.90	152.40	39.69	SET415	120.00	165.00	29.00	SET1085
88.90	161.93	47.63	SET929	120.00	180.00	38.00	SET1053
89.98	146.98	40.00	SET414	120.00	180.00	38.00	32024X-9X064
89.98	146.98	40.00	HM218248Z/ HM218210	120.00	180.00	48.00	33024
90.00			SET1242	120.00	215.00	61.50	SET1071
90.00	140.00	32.00	SET1048	127.00			SET111
90.00	140.00	32.00	SET1285	136.53	190.50	39.69	SET1130
90.00	140.00	39.00	SET1090	139.70	215.90	47.63	74550/74850
90.00	145.00	35.00	JM718149A/ JM718110				SET1300
90.00	150.00	42.00	SET1191				SET1301
90.00	150.00	45.00	SET1104				SET1303
90.00	160.00	32.50	SET1024				SET1306
90.00	160.00	32.50	SET1024				SET1304
90.00	160.00	42.50	SET1067				EK50024
90.00	160.00	125.00	NP318274-90UA4				EK50029
90.00	160.00	125.00	SET1242				SET1307
90.00	160.00	125.00	SET1257				EK50036
90.00	161.93	53.98	6581X/6535				EK50042
92.08	152.40	39.69	598/592A				EK50045
92.08	152.40	39.69	SET404				EK50046
92.08	152.40	39.69	598X/592A				SET1299
							SET1309

**ARVINMERITOR**

99041022	SET405
99041025	641/632
99041034	665A/653
99041035B	SET414
99041035S	SET414
99041045B	SET1113
99041045S	SET1113
99041057	SET1067
99041058	SET1069
99041067	EK50045
99041067B	SET1102
99041068	EK50046
99041068B	EK50046
99041075	SET1254
99041076	NP727209-90KA1
99049413	HM212044/HM212011
A1228A599	SET418
A1228G605.M	72212C/72487
A1228Q1317	SET401
A1228Q1499	SET1237
A1228R1006	SET1181
A1228R642	34306/34478
A1228S1033.M	65237/65500
A1228V594.M	SET1143
A1228X1480	SET1242
A1228Z650	HM813843/HM813810
A11228A1535	NP553050/JW7010
A11228B1666	NP707669/H914811
A11228L636	3920

**B.P.W.**

02.6401.20.00	30204
02.6401.25.00	30205
02.6401.30.00	SET1015
02.6401.35.00	SET1016
02.6401.45.00	SET1018
02.6401.50.00	SET1019
02.6401.60.00	SET1020
02.6404.35.00	32007X
02.6405.60.00	SET1061
02.6405.95.00	SET1068
02.6406.45.00	SET1078
02.6406.50.00	SET1079
02.6406.70.00	SET1083
02.6407.45.00	SET1109
02.6407.65.00	SET1113
02.6407.75.00	SET1115
02.6407.85.00	SET1117
02.6408.29.00	SET1115
02.6408.80.00	SET1102
02.6408.90.00	SET1104
02.6410.22.00	SET1113
02.6410.23.00	SET1104
02.6410.24.00	SET1102
02.6410.25.00	SET1079
02.6410.26.00	32222
02.6410.28.00	SET1068
09.02.6407.65.00	SET414

**BEDFORD**

410707	SET1067
1041617	3977X/3921XA
2690284	SET1135
2702062	SET403
6311391	42686/42624
6311750	575S/572
6314106	482A/472
6371978	SET216
7058557	SET1125
7088587	SET1119
7119513	2580/2520
7132203	SET401
7133236	495A/493
7139286	478XA/473XS

**BEDFORD...**

7174004	SET278
7174007	SET1119
7181959	SET123
7182008	H414245X/H414210
8824111	LM67048/LM67010
8845471	18790/18720
8845472	18690/18620
8849611	528R/522
11054489	LM11749/LM11710
BT7084095	SET1015

**BMC**

7M52913	30205M
---------	--------

**BRISTOL**

10871003/4	SET109
10902762/63	H212749/H212710
10902764/65	SET315
B71092	SET361
B71093	SET325

**DAF**

13H6552	SET1178
77060	SET1048
140896	SET1078
174589	SET404
174592	SET405
174595	681A/672
174597	SET109
202824	SET278
202825	SET102
221664	XAA33115
254912	SET325
260204	SET1300
260724	SET508
260725	SET1130
266488	SET1306
275823	SET1080
275828	XAA32311
283684	SET1078
283686	SET1078
325333	SET1128
325402	3782/3720
325405	5583/5535
491899	32206
491966	SET1119
494535	18690/18620
495520	SET416
541123	6379/6321
542137	SET262
556289	SET1079
556290	SET1304
575168	SET1138
614943	SET1110
622102	SET361
626875	SET1079
631442	SET1090
636819	XAA33212-90KA1
636820	SET1109
640618	SET1046
655407	SET1049
676987	SET1091
676988	SET1303
682375	681A/672
692180	EK50046
699117	SET1050
1400081	SET1177
10271961	495/493
10890343	SET98
10901093	SET325

**DAF...**

10901094	H212749/H212710
RTC3412	18690/18620
RTC3427	L68149/L68110
UKC4805	07087X/07210X

**E R F**

49666	SET408
SL84/107	567X/563
SL84/115	HM515745/HM515716
SL84/116	SET403
SL84/171	SET1139
SL84/217	SET105
SL84/220	SET1137
SL84/283	SET403
SL84/298	56426/56650
SL84/315	SET1151
SL84/316	H212749/H212710
SL84/72	615/612
SL84/73	SET110

**EVOBUS**

9805002	SET226
9805402	SET226
9805502	SET226
9806802	SET272
9807202	SET928
9807402	SET928
9807502	SET1098
9808202	LM503349A/LM503310
9808302	SET1176
9809602	SET1091
9809702	SET1093
9810205	SET1022
9810305	SET1065
9812005	SET1079
9812105	SET1068
9812205	SET1066
9812401	SET1065
9813305	SET1060
9813605	32210
9814518	SET1100
9815605	SET401
9815705	47487/47420
9816105	497/492A
9817205	SET1065
9817405	SET1064
9817505	598/592A
9817905	598/592A
9818302	SET1098
9818405	SET1064
9818905	SET1032
9819002	32011XM
9819005	SET1060
9819405	SET1065
9819505	SET1074
9819605	SET1075
19801002	SET1114
19802502	XGA32021X
19802602	SET1049
19802702	SET1115
19802902	LM48548/LM48510
19806202	LM501349/LM501310
19806602	SET1092
19806702	SET1103
19810405	SET98
19810505	SET272
19811405	497/492A
19811505	32206
19812905	SET1079
19813705	SET1031
19813805	SET272
19813905	SET98
19814505	598X/592A
19814805	SET1064



# CROSS REFERENCE GUIDE

## EOBUS...

19815605	SET1075
19816105	32206
19816205	30211
19816405	SET1050
19816505	SET1015
19816505	32206
19817005	SET1075
19817205	SET1050
19817405	SET1079
19817605	SET1079
19818202	SET1079
19818305	SET1074
19818405	SET1060
19818505	SET1022
19818605	SET1060
19818705	SET1074
19818905	32210
19819005	SET1072
19819505	SET1074
19819705	SET1032
29810005	SET401
29810605	SET98
29811205	SET1040
29811305	32011XM
29811605	47487/47420
29811705	SET1066
29811805	SET1066
29811905	32210
29812005	SET1072
29812205	32210
29812405	SET1060
29812805	2789/2720
29815005	SET1052
29815405	SET1049
29816605	32011XM
29817905	SET1110
29818205	SET1098
29818605	SET1115
29818905	SET1115
29819005	SET1091
29819202	SET928
29819305	SET1086
39811005	33205
39811105	SET1097
39811505	33205
39811605	SET1097
39812505	SET1051
39812605	SET1093
39812705	SET1051
39812805	SET1093
39813205	SET1101
39813705	SET1113
39813905	SET1108
39814105	SET1100
39814305	SET1086
39814705	SET325
39815105	SET1049
39815205	SET1114
39815305	SET1109
39815605	SET1114
39815705	SET1109
39816405	SET1075
39817205	SET1108
39817405	SET1113
39818305	SET1110
39818505	SET1114
39818605	SET1091
39819505	33205
39819605	SET1097
49810705	SET1094
49810905	SET1094
49811305	SET1078
49811705	SET1048
49812105	SET1025
49813405	EK50029
49813805	EK50029
49814205	SET1110
49814605	SET401

## EOBUS...

49814705	SET401
49814805	SET401
49814905	SET1025
49816405	SET1111
49816505	SET1111
49816705	SET1111
49816805	SET1108
49817205	SET1109
49817305	SET1063
49817405	SET1050
49819805	SET1083
49819905	SET1083
59810005	SET1083
59812105	SET1094
59812205	33205
59813105	SET1301
59814005	SET1110
59814105	SET1109
59814405	SET1086
59814905	SET1093
59815305	32210
59815605	SET1048
59816605	SET1044
59816905	SET1088
59818305	SET1103
59818405	SET1092
59818505	SET1092
59818605	SET1103
59819005	SET1052
59819505	SET1044
59819805	SET1044
59819905	SET1103
69810105	SET1092
69810605	SET1065
69810705	SET1075
69810805	SET1080
69814705	SET1049
69815205	SET1114
69815605	32011XM
69815905	SET1074
69816905	SET1080
69817005	33013
69817405	SET1080
69818205	SET1098
69819905	SET1079
79810405	32011XM
79814505	32008X
79815705	SET1086
79817605	32206
79819005	SET1046
89817505	SET1108
99810805	SET1307
99814105	SET1040
99814305	SET317
99818105	SET115
99819305	SET1086
109819305	SET1080
119816805	SET1081
119816905	SET1081
129814005	SET1102
129819205	SET1032
129819705	SET1019
139813905	SET1307
139814205	SET1307
159817505	SET1081
720032013	SET1043
720032014	SET1044
720032016	SET1046
720032018	SET1048
720032206	32206
720032211	SET1060
720032216	SET1065
720032306	SET1074
720032307	SET1075
1249810305	SET226
1409810005	33205
3129810501	SET1074
3199810205	SET1060
3199810405	32210

## EOBUS...

3199810605	SET1072
3279810305	SET1064
3279810405	SET1066
3279812205	SET1066
6319810005	SET1018
72003202480	SET1053

## FODEN

FL110/17	SET289
FL110/18	SET405
FL110/29	SET113
FL110/30	SET315
FL110/31	SET408
FL110/33	SET323

## FORD

A790X 1200BA	SET278
TAJAA 1238 A	SET401

## FRUEHAUF

AJA0813.001	SET415
M003168	SET1299

## GIGANT

10500474	32208
10500496	32210
10500505	SET1069
10500558	SET1113
10500572	SET1102
10500574	SET1103
10500582	SET1104
10500787	SET1071
10500799	SET1108
10500858	SET1115
10500859	SET1068
10500872	32222
10500873	SET1083
M003168	SET1299

## IVECO

354821	SET349
521125	SET123
521194	SET98
521195	SET123
564707	SET1067
626153	SET1115
634049	SET74
712166	SET1116
819015	30211
914220	SET1117
1101597	SET1041
1102042	SET1045
1102857	30215
1102858	SET1024
1102859	SET1032
1102860	SET1053
1102864	SET1026
1103141	SET1045
1103142	SET1063
1103228	SET1048
1103360	SET1053
1103771	SET1064
1104922	SET1051
1104923	SET1091
1109968	SET1023
1109981	SET1031



IVECO...

1110000	32206	7166346
1110002	32208	7166349
1110003	32210	7169935
1110016	SET1075	7172776
1110018	SET1078	7174945
1110019	SET1078	7174946
1110020	SET1079	7177004
1125573	SET1061	7181852
1125929	SET1060	7182915
1126121	SET1022	7183074
1126887	SET1076	7184079
1133049	SET1089	7189050
1307560	HM813841/HM813811	7982089
1382911	HM807046/HM807010	7984896
1384728	47487/47420	8190538
1384729	SET262	8194950
1516177	SET278	8194951
1516190	SET123	8194953
1525734	SET105	8194957
1525744	SET98	8194958
1905000	SET403	8194959
1905018	18690/18620	8194960
1905019	18790/18720	8197270
1905027	SET1050	8582739
1905079	LM48548/LM48510	8582740
1905171	SET1286	8835016
1905172	SET1286	8850842
1905214	SET1157	8857787
1905215	SET240	9920193
1905216	SET1044	9980734
1905217	SET83	9980735
1905219	SET1207	9980739
1905220	SET1293	9980740
1905221	SET1199	9985454
1905222	SET1195	24903810
1905236	SET1111	26799980
1905236	SET1201	26800040
1905249	594/593X	26800130
1905252	SET1096	26800140
1905261	SET1108	26800160
1905273	SET1208	26800170
1905296	SET1114	26800230
1905349	594/593X	26800240
1905350	SET1068	26800250
1905351	SET1069	26800270
1905356	JP14049/JP14010	26800330
1905389	SET1178	26800350
1905391	72212C/72487	26800370
1905392	SET361	26800380
1905474	SET1255	26800390
1905492	SET1110	26800580
4021567	29590/29521	26800600
4023140	2789/2720	26800610
4096587	LM48548/LM48510	26800620
4330647	XAA32010X	26800640
4330648	XAA32008X	38540711
4470124	32006X	38981836
4540025	6386/6320	41800341
4573681	6581X/6535	41800342
4690299	SET1100	42101665
4711928	SET115	42103253
5996248	32206	42471026
6077541	LM67048/LM67010	42471035
7074945	SET1104	42492259
7160360	SET1098	42538863
7160361	SET1112	60115335
7160953	SET1179	60141947
7162191	SET1041	93161536
7162243	SET1042	93803934
7162944	SET1048	93803935
7164196	SET1103	93806250
7164410	SET1044	99041057
7164487	SET1043	99041067
7164502	32208	3612949000
7164503	32308B	5000392236
7164543	SET1287	
7164544	SET1066	
7164705	SET349	
7165686	SET1111	

IVECO...

SET325	6.691.128.000
SET98	6.691.130.000
SET1107	6.691.159.000
SET240	6.691.161.000
SET1104	6.691.168.000
SET1113	6.691.169.000
SET1070	6.691.299.000
NP347723/NP414027	6.691.383.000
SET1263	6.691.383.000E
SET1242	6.691.450.000
SET1237	6.691.453.000
SET1242	
EK50046	
SET1050	
SET1051	
SET1178	
34306/34478	
SET1148	
SET1143	
SET418	
SET1169	
64450/64700	
SET1015	
SET1108	
SET1106	
SET1015	
SET1030	
SET1015	
SET1015	
18790/18720	
18690/18620	
387/382	
SET1121	
EK50045	
32008X	
SET1019	
SET1022	
32207	
32208	
32210	
SET1060	
SET1066	
SET1067	
SET1068	
SET1070	
30305	
SET1030	
SET1031	
30310	
SET1081	
SET1076	
SET1079	
SET1080	
30311	
SET1083	
30211	
SET1053	
SET1093	
SET1117	
HM212044/HM212011	
SET1104	
HM801346X/HM801310	
18790/18720	
SET1111	
SET325	
SET1047	
SET1043	
SET1050	
30305	
32305	
30305	
SET1067	
EK50045	
SET1067	
SET1040	

KÄSSBOHRER

SET1022	6.691.128.000
SET1024	6.691.130.000
SET1065	6.691.159.000
SET1067	6.691.161.000
SET1078	6.691.168.000
SET1079	6.691.169.000
SET1115	6.691.299.000
SET1301	6.691.383.000
SET1301	6.691.383.000E
SET1052	6.691.450.000
SET1051	6.691.453.000

LEYLAND

83H0205-204	SET325
83H0205-83H0204	SET325
5539Z106	SET401
5539Z285	SET123
5539Z385	748S/742
5539Z391	SET98
24857	SET401
69092	SET110
132177	SET109
182434	SET210
271961	495/493
274960	495A/493
527505	SET216
540131	SET1137
553448	SET508
563185	SET103
563186	HM212044/HM212011
563187	495/493
824439	H212749/H212710
824482	SET123
824483	SET408
824484	25580/25520
825439	H212749/H212710
861724	SET289
863750	SET102
2481134	SET98
10870997/98	H212749/H212710
10871001/2	SET401
10871003/4	SET109
10871009/10	566/563
10871016/17	SET216
10871018/19	SET103
10871021/22	HM212044/HM212011
10871023/24	495/493
10901093	SET325
10901094	H212749/H212710
10902762/63	H212749/H212710
10902764/65	SET315
ABL5781	SET317
ABU8700	SET317
AJU1914	H212749/H212710
AJU1918	SET1109
AKU2250-SC15641	SET278
AKX2509-AKV4438	SET103
APX2870-APV5008	567X/563
APX3259-APV5508	SET1137
APX3259-APX5508	SET1137
AWX3759-AWV6008	SET403
B71092	SET361
B71093	SET325
B71094	H212749/H212710
C140991	SET113
C140992	SET98
CAL1908	SET113
CAL2034	SET210
CHM3	SET278
CHM4	SET1119
CHM7	SET103
CHM8	567X/563
EAW3109-EAW3009	SET210
EAW3146-EAW3046	H212749/H212710
EAW3149-EAW3049	SET102
GHB105	LM67048/LM67010



# CROSS REFERENCE GUIDE

## LEYLAND...

GHB191	07087X/07210X
NAK 9186	32206
NAK9185	SET1109
NAK9186	32206
RAK1852	SET1125
RF16197	SET216
RTC3427	07087X/07210X

## MAN

06.32480.1000	SET1045
06.32480.1200	SET1047
06.32481.1200	SET1047
06.32489.0002	SET1108
06.32489.0003	SET1109
06.32489.0004	SET1110
06.32489.0006	SET1113
06.32489.0009	XGA32021X
06.32489.0011	SET1048
06.32489.0012	SET1049
06.32489.0019	30215
06.32489.0021	SET1024
06.32489.0032	SET1025
06.32489.0041	SET1110
06.32489.0044	SET1109
06.32489.0045	SET1112
06.32489.0046	SET1113
06.32489.0048	SET1019
06.32489.0051	SET1048
06.32489.0060	SET1047
06.32489.0063	SET1053
06.32489.0070	SET1051
06.32489.0071	SET1051
06.32489.0072	EK50024
06.32489.0073	EK50024
06.32489.0080	32208M
06.32489.0091	SET1047
06.32489.0114	SET1049
06.32489.0115	SET1049
06.32489.0116	SET1051
06.32489.1800	SET1053
06.32490.3200	SET1079
06.32499.0005	SET1064
06.32499.0013	SET1078
06.32499.0016	SET1079
06.32499.0020	SET1083
06.32499.0034	SET1079
06.32499.0036	SET1091
06.32499.0039	SET1100
06.32499.0040	SET1101
06.32499.0043	SET1300
06.32499.0044	SET1094
06.32499.0058	SET1089
06.32499.006	32206
06.32499.0062	32208M
06.32499.0063	32208
06.32499.0065	SET1106
06.32499.0068	32207
06.32499.0073	SET1100
06.32499.0079	32207M
06.32499.0080	32206
06.32499.0081	SET1300
06.32499.0096	SET1093
06.32499.0098	3984/3927X
06.32499.0099	3984/3927X
06.32499.0100	3984/3927X
06.32499.0101	39585/39520
06.32499.0102	39585/39520
06.32499.0103	SET325
06.32499.0108	SET1100
06.32499.0109	SET1088
06.32499.0116	SET1100
06.32499.0126	SET1306
06.32499.0127	SET1306
06.32499.0131	SET1101

## MAN...

06.32499.0137
06.32499.0138
06.32499.0151
06.32499.0155
06.32499.0175
06.32499.0176
06.32499.0183
06.32499.0188
06.32499.0189
06.34299.0066
81.44050.0070
81.44050.0075
81.93420.0055
81.93420.0056
81.93420.0072
81.93420.0074
81.93420.0077
81.93420.0078
81.93420.0080
81.93420.0106
81.93420.0131
81.93420.0157
81.93420.0163
81.93420.0205
81.93420.0246
81.93420.0270
81.93420.6001
81.93420.6016
81.93420.6059
81.93420.617
81.93501.0028
87.52330.0600
773220600
6324890042
81934200089

## MERCEDES - BENZ

000 980 97 02
001 980 09 02
003 981 26 05
003 981 28 05
003 981 37 05
003 981 74 05
004 981 19 05
004 981 20 05
005 981 49 05
011.981.0805
00698161 05
01198123 05
01198136 05
9801402
9804202
9805002
9805402
9805502
9806802
9807202
9807402
9807502
9808202
9808302
9809002
9809602
9809702
9810205
9810305
9812005
9812105
9812205
9812401
9813305
9813605
9814005
9814105
9814518

## MERCEDES - BENZ...

9814605	39586/39528
9815402	SET226
9815605	SET401
9815705	47487/47420
9815805	LM67048/LM67010
9816105	497/492A
9817205	SET1065
9817405	SET1064
9818302	SET1098
9818405	SET1064
9818905	SET1032
9819002	32011XM
9819005	SET1060
9819405	SET1065
9819505	SET1074
9819605	SET1075
19800902	SET1113
19801002	SET1114
19802502	XGA32021X
19802602	SET1049
19802702	SET1115
19802902	LM48548/LM48510
19806202	LM501349/LM501310
19806602	SET1092
19806702	SET1103
19810405	SET98
19810505	SET272
19811405	497/492A
19811505	32206
19812905	SET1079
19813705	SET1031
19813805	SET272
19813905	SET98
19814505	598X/592A
19814805	SET1064
19815605	SET1075
19816105	32206
19816205	30211
19816405	SET1050
19816505	32206
19817005	SET1075
19817205	SET1050
19817405	SET1079
19817505	SET1034
19817605	SET1079
19817705	SET1034
19818202	SET1079
19818305	SET1074
19818405	SET1060
19818505	SET1022
19818605	SET1060
19818705	SET1074
19818905	32210
19819005	SET1072
19819505	SET1074
19819705	SET1032
29810005	SET401
29810505	SET272
29810605	SET98
29811205	SET1040
29811305	SET1041
29811605	47487/47420
29811705	SET1066
29811805	SET1066
29811905	32210
29812005	SET1072
29812205	32210
29812405	SET1060
29812705	2789/2720
29812805	2789/2720
29815005	SET1052
29815405	SET1049
29816405	SET1076
29816605	32011XM
29817905	SET1110
29818205	SET1098
29818405	SET1091
29818605	SET1115
29818905	SET1115

**MERCEDES - BENZ...**

29819005 SET1091  
 29819202 SET928  
 29819305 SET1086  
 39811005 33205  
 39811105 SET1097  
 39811505 33205  
 39811605 SET1097  
 39812505 SET1051  
 39812605 SET1093  
 39812705 SET1051  
 39812805 SET1093  
 39813205 SET1101  
 39813705 SET1113  
 39813905 SET1108  
 39814105 SET1100  
 39814305 SET1086  
 39814705 SET325  
 39815105 SET1049  
 39815205 SET1114  
 39815305 SET1109  
 39815405 SET1049  
 39815605 SET1114  
 39815705 SET1109  
 39816405 SET1075  
 39817205 SET1108  
 39817405 SET1113  
 39818305 SET1110  
 39818505 SET1114  
 39818605 SET1091  
 39819505 33205  
 39819605 SET1097  
 49810705 SET1094  
 49810905 SET1094  
 49811305 SET1078  
 49811705 SET1048  
 49812005 XGA32021X  
 49812105 SET1025  
 49812105 SET1025  
 49812305 SET1300  
 49812405 SET1300  
 49813405 EK50036  
 49813805 EK50036  
 49813905 SET1300  
 49814205 SET1110  
 49814305 SET1048  
 49814605 SET401  
 49814705 SET401  
 49814805 SET401  
 49814905 SET1025  
 49814905 SET1025  
 49816405 SET1111  
 49816505 SET1111  
 49816705 SET1111  
 49816805 SET1108  
 49817205 SET1109  
 49817305 SET1063  
 49817405 SET1050  
 49819805 SET1083  
 49819905 SET1083  
 59810005 SET1083  
 59811405 SET1047  
 59811505 SET1047  
 59812105 SET1094  
 59812205 33205  
 59813005 SET1301  
 59813105 SET1301  
 59814005 SET1110  
 59814105 SET1109  
 59814405 SET1086  
 59814905 SET1093  
 59815305 32210  
 59815605 SET1048  
 59816605 SET1044  
 59816905 SET1088  
 59818305 SET1103  
 59818405 SET1092  
 59818505 SET1092  
 59818605 SET1103

**MERCEDES - BENZ...**

59818805 SET1301  
 59819005 SET1052  
 59819505 SET1044  
 59819805 SET1044  
 59819905 SET1103  
 69810005 SET1048  
 69810105 SET1092  
 69810405 SET1050  
 69810605 SET1065  
 69810705 SET1075  
 69810805 SET1080  
 69814205 SET1031  
 69814505 SET1040  
 69814705 SET1049  
 69815205 SET1114  
 69815605 32011XM  
 69815905 SET1074  
 69816005 SET1111  
 69816105 EK50036  
 69816305 SET1113  
 69816905 SET1080  
 69817005 33013  
 69817405 SET1080  
 69818205 SET1098  
 69819905 SET1079  
 79810005 SET1025  
 79810405 32011XM  
 79811405 SET1042  
 79814505 32008X  
 79815705 SET1086  
 79817605 32206  
 79817605 32206  
 79819005 SET1046  
 79819405 SET1046  
 89813605 SET1098  
 89815305 SET325  
 89817505 SET1108  
 99810805 SET1307  
 99814105 SET1040  
 99814305 SET317  
 99816005 SET1040  
 99818105 SET1115  
 99819305 SET1086  
 99819401 SET1051  
 109819305 SET1080  
 119816805 SET1081  
 119816905 SET1081  
 129813205 SET1083  
 129814005 SET1102  
 129814105 SET1102  
 129819205 SET1032  
 129819705 SET1019  
 139813905 SET1307  
 139814205 SET1307  
 139814305 SET1307  
 149810605 SET1107  
 159810005 SET1047  
 159810805 SET1047  
 159817505 SET1081  
 179814905 SET1102  
 20030220 SET1025  
 220032013 SET1043  
 220032014 SET1044  
 220032016 SET1046  
 220032018 SET1048  
 220032019 SET1049  
 220032206 32206  
 220032211 32210  
 220032216 SET1060  
 220032217 SET1065  
 220032304 SET1066  
 220032306 SET1072  
 220032307 SET1074  
 220032310 SET1075  
 220432210 SET1079  
 220432210 32210  
 1249810305 SET226  
 1409810005 SET1103

**MERCEDES - BENZ...**

3129810501 SET1074  
 3199810005 32207  
 3199810205 SET1060  
 3199810405 32210  
 3199810605 SET1072  
 3279810305 SET1064  
 3279810405 SET1066  
 3279812205 SET1066  
 6319810005 SET1018  
 72003202480 SET1053  
 A6319800002 SET1040  
 A6319810005 SET1018

**MERCEDES - DISCOS**

79817005 SET1117

**NISSAN - EBRO**

40210A0100 LM67048/LM67010  
 40210G9500 SET1018  
 062179-0 SET1068  
 062180-0 SET1024  
 300142-X1 SET1072  
 339440 SET1018  
 390503-X1 SET1019  
 390876-X1 SET1075  
 1422111-M1 32006X  
 1440637-X1 32207M  
 1831311-M91 30310  
 1833568-M1 30205  
 2723259-X SET1040  
 04305054-0 32207  
 SS09-0018A SET1078  
 SS09-0050A SET1115  
 SS09-0054A SET1090  
 SS09-0055A SET1089  
 SS09-0064A 30205

**RENAULT RVI**

366.010.4500 SET1018  
 366.100.4200 SET401  
 366.100.5700 SET98  
 366.101.0300 SET123  
 366.101.3800 H212749/H212710  
 785895 SET1166  
 1928925 SET1042  
 23336006 SET109  
 23336033 SET1045  
 23336042 JH211749/JH211710  
 23336044 SET1051  
 23336046 SET1169  
 23336061 SET1114  
 23336074 64432/64708  
 23336078 SET1097  
 23336081 SET1112  
 23336084 SET110  
 23336094 SET1087  
 23336102 SET1075  
 23336103 SET315  
 23336108 SET414  
 23336111 SET1114  
 23336123 SET1169  
 23336124 64432/64708  
 23336131 SET1109  
 23336246 SET1047  
 23336266 SET1097  
 23336288 SET411  
 23336853 SET361  
 23336859 52375/52618  
 23336864 SET1178  
 23336874 SET361  
 23336956



# CROSS REFERENCE GUIDE

## RENAULT RVI...

23356131 SET1109  
 23431209 SET1018  
 23431210 SET1019  
 23431211 30211  
 23432213 SET1062  
 23432218 SET1067  
 23432307 SET1075  
 23874099 42687/42620  
 23874324 SET411  
 773021100 30211  
 773030900 SET1031  
 773220800 32208  
 773220800 32208M  
 773220900 SET1058  
 773221500 SET1064  
 773230500 32305  
 773230700 SET1075  
 959032210 32210  
 0959130220M SET1025  
 959232206 32206  
 0959232206M 32206  
 959232207 32207  
 959232208 32208  
 959232208 32208M  
 959232209 SET1058  
 959232211 SET1060  
 959232214 SET1063  
 959232215 SET1064  
 959232217 SET1066  
 959232218 SET1067  
 959232219 SET1068  
 959232220 SET1069  
 959443021 SET1093  
 959532207 32207M  
 959532212 SET1061  
 959532216 SET1065  
 959532218 SET1067  
 959532309 SET1078  
 959532310 SET1079  
 959532311 SET1080  
 959532312 SET1081  
 959532313 SET1082  
 959532314 SET1083  
 959901065 SET110  
 959901082 SET401  
 959901092 598/592A  
 959901208 SET98  
 959902085 665X/653X  
 959904216 594/593X  
 5000020631 SET1026  
 5000021842 SET1067  
 5000021895 SET1052  
 5000254793 SET1048  
 5000350020 SET1090  
 5000350029 SET1089  
 5000350189 33013  
 5000350270 SET1087  
 5000388284 32207  
 5000389250 32011XM  
 5000391585 SET1040  
 5000392236 SET1040  
 5000392237 32011XM  
 5000434273 SET1109  
 5000437785 SET1109  
 5000437786 SET1113  
 5000437791 SET1113  
 5000442185 SET1110  
 5000442186 SET1110  
 5000442189 SET1110  
 5000443519 SET1111  
 5000470672 SET1110  
 5000470673 SET1114  
 5000470861 SET1110  
 5000470862 SET1114  
 5000546524 SET1108  
 5000598486 SET1111  
 5000609898 SET1114  
 5000609900 SET1022  
 5000669957 SET1110

## RENAULT RVI...

5000671939 SET361  
 5000673467 SET1107  
 5000675133 SET1049  
 5000675250 SET1103  
 5000675627 SET1116  
 5000682543 SET1069  
 5000682544 SET323  
 5000682662 SET1049  
 5000682886 JM718149A/JM718110  
 5000685691 SET1043  
 5000685835 SET1087  
 5000685836 33013  
 5000685837 SET1088  
 5000685838 SET1089  
 5000685839 SET1090  
 5000685959 SET1042  
 5000690018 SET1107  
 5000785895 SET1166  
 5000785898 SET1116  
 5000785909 SET1116  
 5000785910 SET1166  
 5000786292 SET1046  
 5000786298 SET1111  
 5000788406 SET1101  
 5000788712 SET1107  
 5000873122 SET1113  
 5001014916 SET1052  
 5003090068 SET1106  
 5003090069 SET1109  
 5003090900 SET1109  
 5003090901 SET1106  
 5003090902 SET1096  
 5010067672 SET1113  
 5010136663 SET1114  
 5010136759 SET1096  
 5010136762 SET1108  
 5010136766 SET1106  
 5010136767 SET1109  
 5010136769 SET1113  
 5010241096 SET1049  
 5010241918 32207M  
 5010368899 SET1113  
 5010368900 SET1113  
 5010439054 SET1106  
 5010439055 SET1107  
 5010439057 SET1110  
 5010439061 SET1111  
 5010439064 SET1114  
 5010439065 SET1113  
 5010439224 SET1049  
 5010439301 SET1048  
 5010439570 SET1103  
 5010439571 SET1166  
 5010443768 SET324  
 5010443903 SET1047  
 5010587007 SET1103  
 5010587008 SET1116  
 5010587009 JT9049/10  
 5010587010 SET1166  
 5516010033 SET1087  
 5516010506 32206  
 5516010507 32210  
 5516010573 32207  
 5516010573 32207M  
 5516010574 SET1060  
 5516010587 SET1109  
 5516011446 33013  
 5516014042 32208  
 5516014518 32208  
 5516014518 32208M  
 5516014519 SET1060  
 5516014554 32208  
 5516014554 32208M  
 5516015839 SET1088  
 5516016467 SET1058  
 5516016468 SET1058  
 5516016469 SET1058  
 5516016470 32206  
 5516016470 32206

## RENAULT RVI...

5516016471 SET1058  
 5516016472 32206  
 5516016472 32206  
 5516016784 SET1087  
 5516016786 SET1087  
 5516016788 SET1088  
 7701014445 42687/42620  
 7703090034 32008X  
 7703090085 32206  
 7703090098 30205

## SAF

4200000300 SET1015  
 4200001100 SET1030  
 4200001100 32206  
 4200001200 SET1031  
 4200001300 30310  
 4200001400 30311  
 4200001500 SET1032  
 4200001600 SET1033  
 4200002200 SET1058  
 4200002300 SET1062  
 4200002500 SET1066  
 4200002600 SET1068  
 4200002700 SET1067  
 4200002800 SET1070  
 4200003100 SET1078  
 4200003200 SET1080  
 4200003300 SET1081  
 4200003400 SET1083  
 4200005500 SET1100  
 4200005700 SET1107  
 4200005800 SET1111  
 4200006000 SET1113  
 4200006300 SET1109  
 4200006400 SET1112  
 4200007000 SET1115  
 4200100600 SET414  
 4200100700 SET113  
 4200100900 SET1104  
 4200101000 32924M

## SAURER

8102 SET315  
 81361 SET1178  
 81363 JH211749/JH211710  
 81560 SET325  
 82260 SET1184  
 82261 SET323  
 16080640 SET315  
 16380640 JH211749/JH211710  
 8064000810 SET315  
 8064000813 SET1178  
 8064000822 SET1184

## SCANIA

14102 SET1064  
 14103 SET1065  
 14146 SET1066  
 14611 SET1022  
 14614 SET1074  
 14623 SET1078  
 14698 SET1076  
 14735 SET1079  
 14736 SET1082  
 14764 SET1080  
 14835 SET1067  
 14836 SET1081  
 33948 SET1068  
 77192 SET1075  
 123263 SET1034

SCANIA...

123631	32206
123631	32206
143746	SET289
174717	SET1023
177801	SET1030
177802	SET1031
177892	SET1062
177893	SET1064
178427	SET1080
202635	32207
214104	32208
214104	32208M
214478	SET365
234171	SET361
244347	SET320
260998	SET1115
264700	SET340
264960	SET1052
264961	33017
272716	HM220149Z/HM220110Z
274114	SET1050
284843	SET1108
284992	482/472
315288	SET1106
317350	SET315
322748	SET1165
326826	SET1046
345835	SET1112
351715	SET1052
362226	SET1052
363318	SET1107
366305	SET1032
369624	SET1081
373784	SET1081
391289	SET1034
392039	SET1163
392996	SET243
397314	SET1078
871629	32008X
1109767	SET1096
1121538	SET215
1301682	SET1046
1301683	H913849/H913810
1301694	SET1102
1305878	SET1061
1309568	SET323
1309570	SET1090
1357711	SET1032
1362149	SET1078
1382900	SET1231
1415140	SET1051
1431057	SET1184
1439070	SET1231
1524625	SET414

SCHMITZ CARGOBULL

10277	SET414
10278	SET1113
12547	SET1102
14440	SET1104
15052	SET1113
17062	SET1102
17174	SET1117

SEDDON ATKINSON

5694	SET109
6736	HM515745/HM515716
15884	495A/493
16595	SET278
17397	HM212044/HM212011
22368	H212749/H212710
22369	SET414
22370	SET317
25840	SET1137

SEDDON ATKINSON...

32885	497/492A
41632	LM67048/LM67010
52828	SET317
63265	SET403
63265N	SET403
202007	615/612
202115	SET110
204702	SET105
204707	567X/563
206974	SET216
209240	56426/56650
209970	SET403
210506	SET411
913768	566/563
A10830	SET1139

TRAILOR

6502196Z	SET1113
M003168	SET1299
T6014000T000	JM718149A/JM718110
T6015000T000	SET1179

VOLVO

11044	SET1018
11062	SET1079
11063	SET1075
11064	SET1078
11066	SET1064
11067	SET1065
11073	SET1074
11074	SET1076
11075	SET1061
11076	SET1062
11095	SET1080
11097	30211
11099	32210
11137	SET1058
11148	SET98
18412	30215
18424-18414	SET98
18500-18501	SET1123
18599-18414	SET103
19273-19272	SET1125
19468	SET1067
181001-181002	42687/42620
181077-19276	495A/493
181086	SET1068
181087	SET1065
181124-181125	SET1135
181127-181128	598/592A
181133-183356	SET54
181154/181155	5583/5535
181278-181279	SET109
181280/181281	SET405
181298-181128	SET216
181299-181125	SET401
181337-181346	6386/6320
181338-181402	SET212
181338E-181402	SET212
181348-181125	582/572
181433-181323	HM212044/HM212011
181433-181411	HM212044/HM212011
181434-181008	3782/3720
181546-181352	621-612
181546-181356	621-612
181585-181584	LM11949/LM11910
181588-181587	LM67048/LM67010
181596-181279	SET508
181664-181340	749A/742
181668	SET1076
181669	SET1076
183245	SET408
183326	HM220149Z/HM220110Z
183338	SET1080

VOLVO...

183348	SET113
183424	SET325
183583	32206
183648	SET1107
183667	SET1089
183684	32207
183704	SET216
183763	32208
183763	32208M
183764	SET1058
183765	32210
183766	33013
183767	SET1089
183768	SET1090
183769	SET1060
183777	SET1087
183778	SET1088
184068	SET1045
184088	SET276
184593	SET1058
184623	SET1048
184625	SET1050
184637	SET508
184672	SET1113
184678	SET1101
184679	SET1108
184794	SET405
184795	SET109
190100-181024	SET349
191298-181128	SET216
815816	SET1165
815820	SET276
1194652	SET1078
1584340	SET1165
1652099	SET1061
1652119	SET1023
1652127	SET1108
1652563	SET1112
1654320	SET1163
1654326	SET1114
1656100	SET1034
1656129	JXC25663CA/663DA
1698580	SET414
1699173	SET1048
1699339	SET1117
1699340	SET1081
6770270	EK50044
7011137	SET1058
20428192	SET276





**⚠ WARNING** Failure to follow these warnings could create a risk of serious injury.

Proper maintenance and handling procedures are critical. Always follow installation instructions and maintain proper lubrication.  
Do not attempt to disassemble and reassemble unitized wheel-end hubs and bearing assemblies. Improper reassembly could lead to failure.

**⚠ CAUTION** Failure to follow these cautions could create a risk of injury.

*If a hammer and bar are used for installation or removal of a part, use a mild steel bar (e.g., 1010 or 1020 grade). Mild steel bars are less likely to cause release of high speed fragments from the hammer or bar or the part being removed.*

Please note: Tech Tips is not intended to substitute for the specific recommendations of your vehicle manufacturer. Depending on the application, type of hub assembly and location, processes may vary. Please review the vehicle manufacturer's recommendations before removing or installing components.

### 01 CLEAN WHEEL END COMPONENTS



Remove all residual lubricant and thoroughly clean. Protect against corrosion if bearings are not to be replaced straight away. Fully inspect bearings and, if damage is observed refer to the Timken Bearing Damage Analysis wall chart for identification of damage and take appropriate action to correct - Replace all doubtful bearings.

---

### 02 BEARING CUP REMOVAL



Using a mild steel bar as a driver, remove both bearing cups, alternate strike to ensure cup does not cock and damage hub. Do not use brass, copper or aluminum as drivers as these could result in damage to the bearings.  
Use scallops in shoulder where present.  
Ensure driver does not contact cup seat/hub bore.

---

### 03 SPINDLE CLEANING AND INSPECTION



Remove all residual lubricant and inspect spindle, shoulder, threads and keyway for damage and wear.  
Remove all high spots and burrs with a file, polish with emery cloth.  
Check bearing seats for excessive wear.  
Repair or replace spindles if damaged or worn excessively against the manufacturer s service manual.

---

### 04 CUP SEAT CLEANING AND INSPECTION



Remove all residual lubricant and inspect cup seats and shoulders for damage or wear - Remove all high spots and burrs with a file or emery cloth.  
Wear in hubs will reduce interference fit of cups.  
Repair or replace as required in line with the manufacturer s service manual.



# Maximising Truck Wheel Bearing Performance

## 05 CUP INSTALLATION



Using appropriate specified driver tool or mild steel bar ensure the cups progress squarely into their respective seats.

Listen for the change in strike pitch that indicates that cup is seated correctly. Correct seating against shoulder can be checked with 0.051mm (0.002 ) feeler gauge.

---

## 06-A GREASE LUBRICATION (CONES)



Completely fill bearing cones in area under cage, between all rollers by forcing through from roller large end until grease protrudes from small end.

Coat outside of cage and rollers with grease.

---

## 06-A GREASE LUBRICATION (HUB)



Grease hub cavity to manufacturer s recommendations (normally level with and not exceeding cup race level).

Smear grease or fretting corrosion inhibitor on spindle to prevent fretting corrosion.

---

## 06-B OIL LUBRICATION



Coat bearing cones with clean oil.

Place outboard cone back in packaging to prevent contamination.

### 07 HUB SEAL INSTALLATION



Ensure you select the correct seal for the lubricant being used.  
Place inboard cone squarely into its mating cup in the hub.  
Install hub seal following seal manufacturer's procedure using proper installation tool.  
Listen for change in strike pitch that indicates seal is seated correctly.  
Check seal is squarely in position and undamaged.

---

### 08 HUB ASSEMBLY INSTALLATION ON SPINDLE



Use appropriate wheel dolly to align and present hub assembly to spindle squarely without cocking.

---

### 09 ADJUSTMENT – DOUBLE NUT SYSTEM



Inspect adjusting nut threads and overall condition and install hand tight.  
While rotating wheel, use an appropriate torque wrench and socket(s), follow the torque procedure outlined in Table 1 Wheel Bearing Adjustment Procedure .  
Don't forget to back off the adjusting nut the appropriate amount to suit the specific application prior to installing lock washer(s) and jam nut. Note - For single nut self-locking systems consult manufacturer's instructions.

---

### 10 ENDPLAY MEASUREMENT



The adjustment procedure allows the wheel to rotate freely with 0.025 to 0.125mm (0.001 to 0.005 ) end play Attach dial indicator via magnetic base to hub or drum Adjust indicator so plunger contacts spindle face and its line of action is parallel to centerline of spindle (Aluminum hubs - attach the magnetic base to spindle end with the plunger contacting the hub or drum) Grasp wheel assembly at 3 and 9 o'clock and push while oscillating to seat the bearings. Zero the indicator. Repeat the process only this time pull the wheel while oscillating. The indicator movement is the end play in the hub. Make fine adjustments until endplay is within the range specified above Apply any final retention mechanisms.

# Maximising Truck Wheel Bearing Performance

## 11 INSTALL HUB CAP



Install hub cap using new gasket being careful not to over-tighten bolts as per the manufacturer s instructions.

**Oil lubrication :**

**Add clean oil to hub through provision in hub cap to manufacturer s recommended level.**

**Rotate wheel assembly and recheck.**

**Top up if required.**

### TABLE 1 : WHEEL BEARING ADJUSTMENT PROCEDURE

STEP 1	STEP 2	STEP 3	STEP 4	STEP 5			STEP 6		STEP 7	
Lubricate	Initial Adjusting Nut Torque	Initial Back Off	Final Adjusting Nut Torque	Back Off			Jam Nut Torque	Acceptable End Play		
Lubricate the wheel bearing with clean axle lubricant of the same type used in the axle sump or hub assembly.  NOTE: Never use an impact wrench when tightening or loosening lug nuts or bolts during the procedure.	271 Nm (200 lb-ft) while rotating wheels.	One full turn.	68 Nm (50 lb-ft) while rotating wheels.	<b>Axle Type</b>	<b>Threads per inch</b>	<b>Final Back-off</b>	<b>Nut Size</b>	<b>Torque Specifications</b>	0.025 - 0.125mm (0.001" - 0.005"). As measured per procedure with dial indicator.	
				Steer (Front) Non-drive	12	1/6 turn*				Install Cotter Pin to lock axle nut in position.
					18	1/4 turn*				
					Drive	14	1/2 turn	Less than 66.7mm (2 5/8")		271-407Nm (200-300 lbft)
						18				
				Trailer	12	1/4 turn	66.7mm (2 5/8") and over	Dowel type washer		407-542Nm (300-400 lbft)
					16			Tang type washer**		271-373Nm (200-275 lbft)

\* If dowel pin and washer (or washer tang and nut flat) are not aligned, remove the washer, turn it over, and re-install. If required, loosen the inner (adjusting) nut just enough for alignment.  
 \*\* Bendable type washer lock only: Secure nuts by bending one wheel nut washer tang over the inner and outer nut. Bend the tangs over the closest flat perpendicular to the tang.

**The following service procedures apply to steer, drive and trailer axle assemblies using conventional double nut or single nut systems. If you have a system that differs from what is indicated in this procedure, consult the vehicle manufacturer s procedure.**

### FOREIGN MATERIAL



**Abrasive wear**  
Fine abrasive particle contamination.



**Grooving**  
Large particle contamination imbedding into soft cage material.



**Bruising**  
Debris from other fatigued parts, inadequate sealing or poor maintenance.

### CORROSION/ETCHING

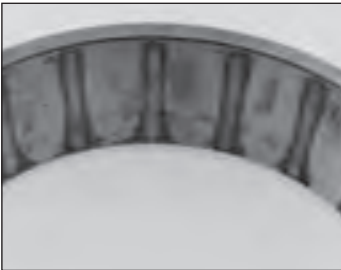

**Staining**  
Surface stain with no significant corrosion from moisture exposure.



**Etching**  
Rusting with pitting and corrosion from moisture/water exposure.



**Line spalling**  
Roller-spaced spalling from bearings operating after etching damage.

### INADEQUATE LUBRICATION\*

*\* Excessive preload can cause damage similar to inadequate lubrication damage.*



**Roller end scoring**  
Metal-to-metal contact from breakdown of lubricant film.



**Cone large rib face scoring**  
Welding and heat damage from metal-to-metal contact.



**Total bearing lock-up**  
Rollers skew, slide sideways and lock-up bearing.



**Cone large rib face deformation**  
Metal flow from excessive heat generation.

# Bearing Damage Analysis

## FATIGUE SPALLING



### Point surface origin

Spalling from debris or raised metal exceeding the lubricant film thickness.

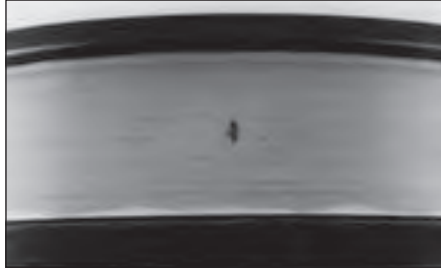

### Inclusion origin

Spalling from oxides or other hard inclusions in bearing steel.



### Geometric stress concentration

Spalling from misalignment, deflections or heavy loading.

## EXCESSIVE PRELOAD OR OVERLOAD



Rapid and deep spalling caused by unusually high stresses. Full race width fatigue spalling is caused by heavy loads creating a thin lubricant film and possible elevated temperatures.

## MISALIGNMENT



Irregular roller path from deflection, inaccurate machining or wear of bearing seats.

## HIGH SPOTS IN CUP SEATS



Localized spalling on the cup race from stress riser created by split housing pinch point.

### HANDLING DAMAGE



**Roller nicking/denting**  
Rough handling or installation damage.

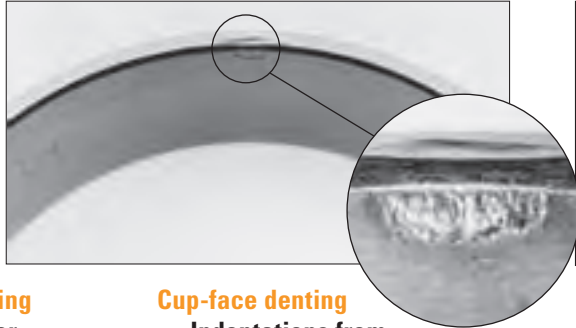

**Cup-face denting**  
Indentations from hardened driver.

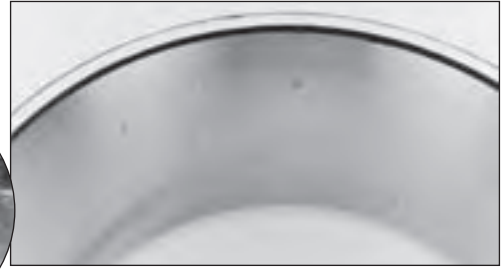

**Roller spaced nicking**  
Raised metal on races from contact with roller edges.

---

### CAGE DAMAGE



**Rollers binding and skewing**  
Cage ring compressed during installation or interference during service.



**Cage deformation**  
Improperly installed or dropped bearing.

---

### IMPROPER FIT



**Cone bore damage**  
Fractured cone due to out-of-round or oversized shaft .



**Cup spinning**  
Loose cup fit in a rotating wheel hub.

# Bearing Damage Analysis

## FALSE BRINELLING

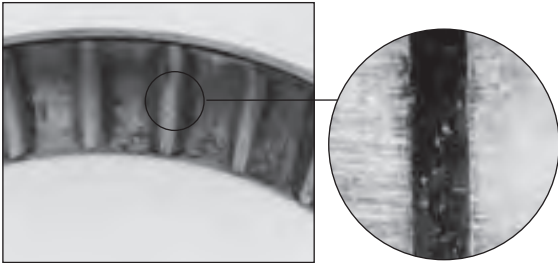

Wear caused by vibration or relative axial movement between rollers and races.

## TRUE BRINELLING

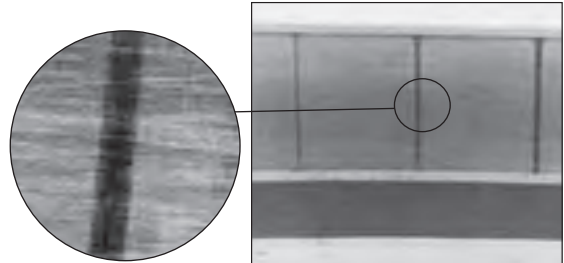

Damage from shock or impact.

## ELECTRIC CURRENT

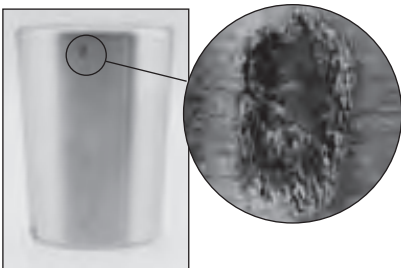

**Electric arc pitting**  
Small burns created by arcs from improper electric grounding while the bearing is stationary.

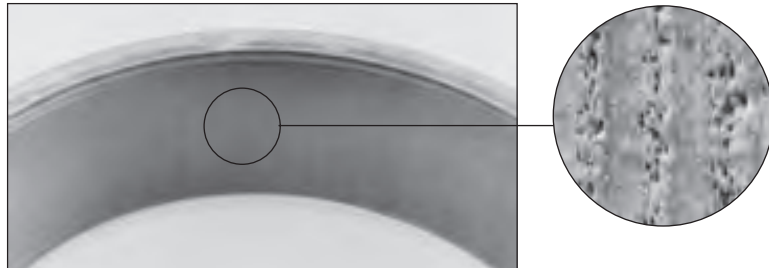

**Fluting**  
Series of small axial burns caused by electric current passing through the bearing while it is rotating.

## PEELING

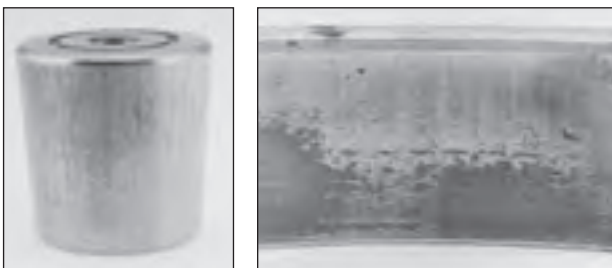

Micro-spalling due to thin lubricant film from high loads/low RPM or elevated temperatures.

## EXCESSIVE END PLAY

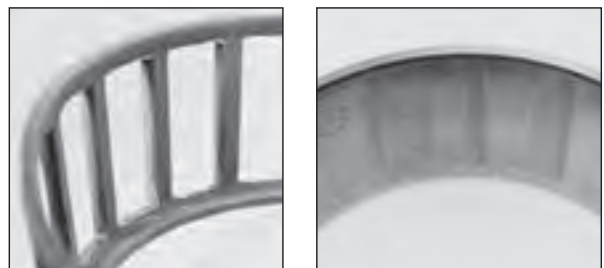

**Cage pocket wear**  
Heavy contact between the rollers and cage pocket surfaces caused by bearing operating too loose.

**Scalloping**  
Uneven localized wear resulting from excessive end play.





## BEARING INSTALLATION TOOLS

# Induction Heater VHIN 10

With more than 100 years of experience in bearing technology, Timken understands the importance of proper maintenance procedures in maximizing product and equipment life. High-quality Timken maintenance products help to decrease down-time and lower operating costs.

Our line of maintenance tools are an example of how we extend beyond bearings with friction management solutions to keep your business running smoothly. These value-added products are grounded in our knowledge of motion, lubrication, friction and metallurgy. Induction Heaters are designed to help you extend bearing life in your applications through proper installation, removal and service.

For more than 100 years, Timken has provided quality products to the industrial marketplace. Induction Heaters are made to the same exacting quality standards you've come to expect from Timken® bearings. Our field support team is available to help you use the tools appropriately, as well as identify other Timken solutions that may boost your productivity and save you money.

Timken offers a large assortment of high-quality induction heaters designed for demanding applications. They can heat and radially expand a wide variety of gears, rings, couplings, bearings and other components.

All heaters are produced in accordance with International (IEC) and European (CE) health and safety requirements. They feature a microprocessor-controlled power supply, automated time and temperature control and automatic demagnetization.

Portable design,  
easy to use,  
ideal for on-site jobs.  
Includes four yokes

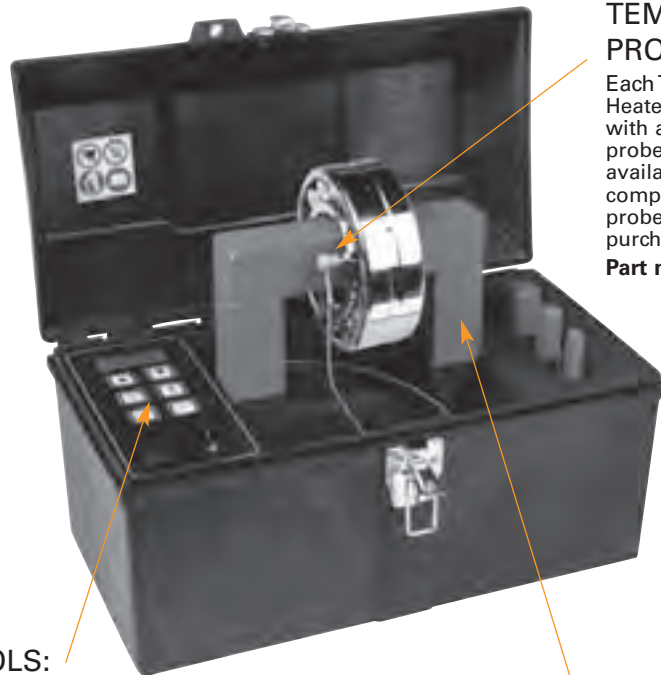

### TEMPERATURE PROBE:

Each Timken Induction Heater model is supplied with a magnetic temperature probe. A clamp is also available for nonferrous components. Replacement probes are also available for purchase.

**Part number: VHIA 100001**

### DIGITAL CONTROLS:

All digital controls operate by time or temperature in °C or °F

### HORIZONTAL SUPPORT:

Support for heating in horizontal position.

## VHIN 10 Model

Min. Bore 15 mm (0.6")  
Max. O.D. 210 mm (8.3")  
Max. Width 120 mm (4.8")  
Max. Weight 15 kg (33 lbs.)

VHIN 10	230V, Yoke set: 10/14/20/40
VHIN 101	120V, Yoke set: 10/14/20/40



<b>Type</b>	<b>VHIN 10</b>
<b>ELECTRICITY</b>	
<b>Power Rating</b>	3.6 k VA
<b>Voltage/Current</b>	120V/20A 230V/16A
<b>Different Voltage Option</b>	—
<b>Frequency</b>	50/60 Hz
<b>Swing Arm</b>	No
<b>Plug</b>	Yes
<b>WORK PIECE</b>	
<b>Max. Weight</b>	
- Bearings	15 kg (33.1 lbs.)
- Other Parts	10 kg (22.1 lbs.)
<b>Min. Bore Diameter</b>	15 mm (0.6")
<b>Max O.D.</b>	210 mm (8.3")
<b>Vertical/Horizontal</b>	
<b>Max. Work Piece Width</b>	120 mm (4.7")
<b>POLE DIMENSIONS</b>	
<b>Area between the poles</b>	120 x 130 mm
<b>Width x Height</b>	(4.7" x 5.1")
<b>Pole Section</b>	40 mm (1.6")
<b>Pole Height</b>	130 mm (5.1")
<b>CONTROLS</b>	
<b>Temperature Control</b>	
<b>Max. Temp</b>	150° C (302° F)
<b>Time Control</b>	
<b>Max. Time</b>	0 – 30 Min.
<b>Auto Power Reduction</b>	—
<b>OPTIONS</b>	
<b>Yokes, Standard</b>	10,14, 20, 40 mm (0.4", 0.6", 0.8", 1.6")
<b>Support for Horizontal Heating</b>	(in case) —
<b>Mobile</b>	—
<b>Temperature Control</b>	—
<b>DIMENSIONS</b>	
<b>Dimensions</b>	435 x 225 x 275 mm (17.1" x 8.9" x 10.8")
<b>Package Size</b>	500 x 250 x 350 mm (19.7" x 9.8" x 13.8")
<b>Mass Heater Body (excludes yokes)</b>	21 kg (46.3 lbs.) (includes yokes)
<b>MISCELLANEOUS</b>	
<b>Sound Signal</b>	yes
<b>Temperature Hold</b>	yes
<b>Demagnetizing &lt;math&gt;\leq 2 A/cm&lt;/math&gt;</b>	yes
<b>Thermal Safety Guard</b>	yes
<b>Magnetic Temperature Probe</b>	yes
<b>DIGITAL DISPLAY</b>	
<b>Temperature</b>	yes
<b>Time</b>	yes
<b>Error Report</b>	yes

### Why choose an induction heater?

Induction heating is a superior, fast and controlled heating method. It is a safe and environmentally friendly alternative for traditional heating methods such as ovens, oil baths or blow torches. These methods cause smoke, fumes or oil waste and are hazardous for personal health and safety.

Timken induction heaters use the principle of induction, similar to a transformer. The heater and yokes remain cool; only the work piece is heated. During the induction heating cycle, a certain degree of magnetism occurs. All Timken heaters demagnetize automatically after each heating cycle.

### Versatility, safety and quality

Timken induction heaters can be used for heating gear wheels, bushings, couplings and other components. Proper mounting lengthens the life span of your equipment, and controlled induction heating helps prevent unnecessary damage.

Digital electronics provide optimal control during the heating process and automatically select the most efficient power supply to ensure balanced and fast heating.

Timken induction heaters are dependable. The robust and easy-to-use designs offer you reliable heaters that are suitable for continuous operation in industrial environments.

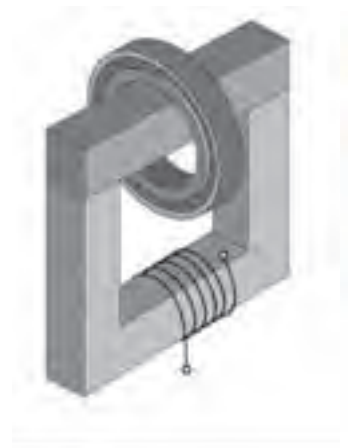

Plug & Heat Models - please add the following suffix to the appropriate part number to identify your plug:

Suffix	Plug type	
-	European plug	
GB	UK 3-pin plug	
US	US 2-flat pin plug	
EN	3-round pin plug	

## BEARING INSTALLATION TOOLS

# Impact Fitting Tool

THIS METRIC MOUNTING SET CONSISTS OF:



- 33 Collets
- 3 Sleeves
- 1 Impact hammer weighing 0.7 kg (1.5 lbs.) absorbs shock and vibration
- Case dimensions:  
430 x 320 x 100 mm  
(16.9" x 12.6" x 4.0")



**Part Number: VIFT 3300**

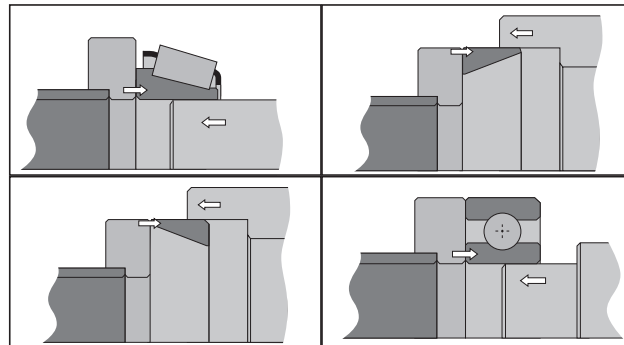

◀ Proper mounting allows the load to be transmitted to the ring experiencing the interference fit. This way, mounting forces are not transmitted via the rolling elements, avoiding damage to the raceways.

Proper mounting is essential to ensure long bearing life. Designed to permit the safe, precise and quick mounting of bearings, bushings, sealing rings, cam wheels and pulleys, the Timken Impact Fitting Tool Set features impact-resistant plastic collets, which help to avoid metal-to-metal contact and the resulting shaft damage.

During the mounting of bearings, such as ball and spherical roller bearings, where the faces lie in the same plane, the collets enable the load to be transmitted to the ring experiencing the interference fit. In this way, mounting forces are not transmitted via the rolling elements and hence damage to the raceways is avoided.

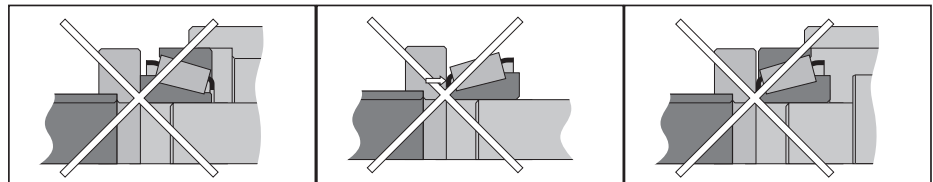

Sleeve	Ring	All ISO bearings codes ending with:	60,62, 63,64	12,22, 13,23	70, 72B, 73B	32, 33	222,213, 223	NU,NJ,N 2 3 4	302, 322, 303, 330	320, 313, 323, 332	
<b>A1</b>	10-26	000	6000	129	7000						
	10-30	200	6200	1200		3200					
				2200							
	10-35	300	6300	1300	7300						
	12-28	001	6001								
	12-32	201	6201	1201		3201					
				2201							
	12-37	301	6301	1301	7301						
				2301							
	15-32	002	6002								
	15-35	202	6202	1202	7202B	3202					
				2202							
	15-42	302	6302	1302		3302			30302		
				2302							
	17-35	003	6003								
				16003							
	17-40	203	6203	1203	7203B	3203			30203		
			2203								
17-47	303	6303	1303	7303B	3303			30303	32303		
			2303								
<b>B2</b>	20-42	004	6004		7004					32004	
	20-47	204	6204	1204	7204B	3204		204	30204		
				2204							
	20-52	304	6304	1304	7304B	3304	21304	304	30304	32304	
			403	6403	2304						
	25-47	005	6005		7005					32005	
	25-52	205	6205	1205	7205B	3205	22205	205	30205	33205	
				2205				32205			
	25-62	305	6305	1305	7305B	3305	21305	305	30305	31305	
			404	6404	2305					32305	
	30-55	006	6006							32006	
	30-62	206	6206	1206	7206B	3206	22206	206	30206	33206	
				2206				32206			
	30-72	306	6306	1306	7306B	3306	21306	306	30306	31306	
			405	6405	2206			405		32306	
	<b>C3</b>	35-62	007	6007		7007					32007
		35-72	207	6207	1207	7207B	3207	22207	207	30207	33207
				2207				32207			
35-80		307	6307	1307	7307B	3307	21307	307	30307	31307	
			406	6406	2307			406		32307	
40-68		008	6006							32008	
40-80		208	6208	1208	7208B	3208	22208	208	30208	33208	
								32208			
40-90		308	6308	1308	7308B	3308	21308	308	30308	31308	
			407	6407	2308		22308	407		32308	
45-75		009	6009							32009	
45-85		209	6209	1209	7209B	3209	22209	209	30209	33209	
				2209				32209			
45-100		309	6309	1309	7309B	3309	21309	309	30309	31309	
			408	6408	2309		22309	408		32309	
50-80		010	6010							33010	
50-90		210	6210	1210	7210B	3210	22210	210	30210	33210	
			2210				32210				
50-110	310	6310	1310	7310B	3310	21310	310	30310	31310		
		409	6409	2310		22310	409		32310		

Impact rings 50-90, 45-100, 50-110 also fit the following bearing where only the outer ring is to be fitted (e.g. shaft is not installed)

<b>C3</b>	50-90		6011						
			6012						
	45-100		6013	1211	7211B	3211	22211	211	
			6211	2211	7212B				
	50-110		6014	1212	7213B	3212	22212	212	
			6015	1213		3213	22213	213	
			6212	2213		3211	21311	311	
			6213	2213			22311	410	
			6311	1311					
			6410	2311					

For tapered bearings, impact rings fit outer ring and also inner ring if driving is from larger diameter side. The numbers on each impact ring (e.g. 25-62) are clearly marked on the ring. The first figure refers to shaft diameter, the second to bearing outer diameter

## Mechanical Pullers



After the required type of puller has been identified, it is easy to choose the most suitable model from the series listed in the catalog.

Please note: Understanding the work space and possibility of gripping will ensure proper fit of grip.

Compare size and measurement of the part to be removed to the values indicated in the tables to choose the suitable puller. The choice of mechanical puller depends also on required pulling force.

The most important factor is safety. If you're not sure which size puller to use, always choose the larger or stronger one. Three-arm pullers better distribute the pulling force than two-arm devices. Therefore, if there is enough space, three-arm pullers should be the first choice.

**NEW**

### Mechanical 3-Jaw Pullers

For economical-minded maintenance professionals, Timken offers a simple to use mechanical line of pullers. Several of our mechanical pullers have a self-centering feature – making life easier for you.

## Mechanical Pullers



Model	Max. Withdrawal Force	Arm Length	Width of Grip	Stroke Width	A	B	C	D	E	F	G	Mass
<b>VMPS2</b>	2 t	80 mm (3.1 in.)	120 mm (4.7 in.)	-	8.3 mm (0.3 in.)	6 mm (0.2 in.)	15 mm (0.6 in.)	-	-	-	16 mm (0.625 in.)	1.6 kg (3.5 lbs.)
<b>VMPS3</b>	3	120 mm (4.7 in.)	180 mm (7.1 in.)	-	6 mm (0.2 in.)	7 mm (0.3 in.)	15 mm (0.6 in.)	-	-	-	16 mm (0.625 in.)	2.3 kg (5.1 lbs.)
<b>VMPS5</b>	5 t	160 mm (6.3 in.)	270 mm (10.6 in.)	-	11 mm (0.4 in.)	10 mm (0.4 in.)	25 mm (1 in.)	-	-	-	19 mm (0.75 in.)	4.3 kg (9.5 lbs.)
<b>VMPS8</b>	8	210 mm (8.3 in.)	300 mm (11.8 in.)	-	13 mm (0.5 in.)	14 mm (0.6 in.)	27 mm (1.1 in.)	-	-	-	19 mm (0.75 in.)	6.1 kg (13.4 lbs.)

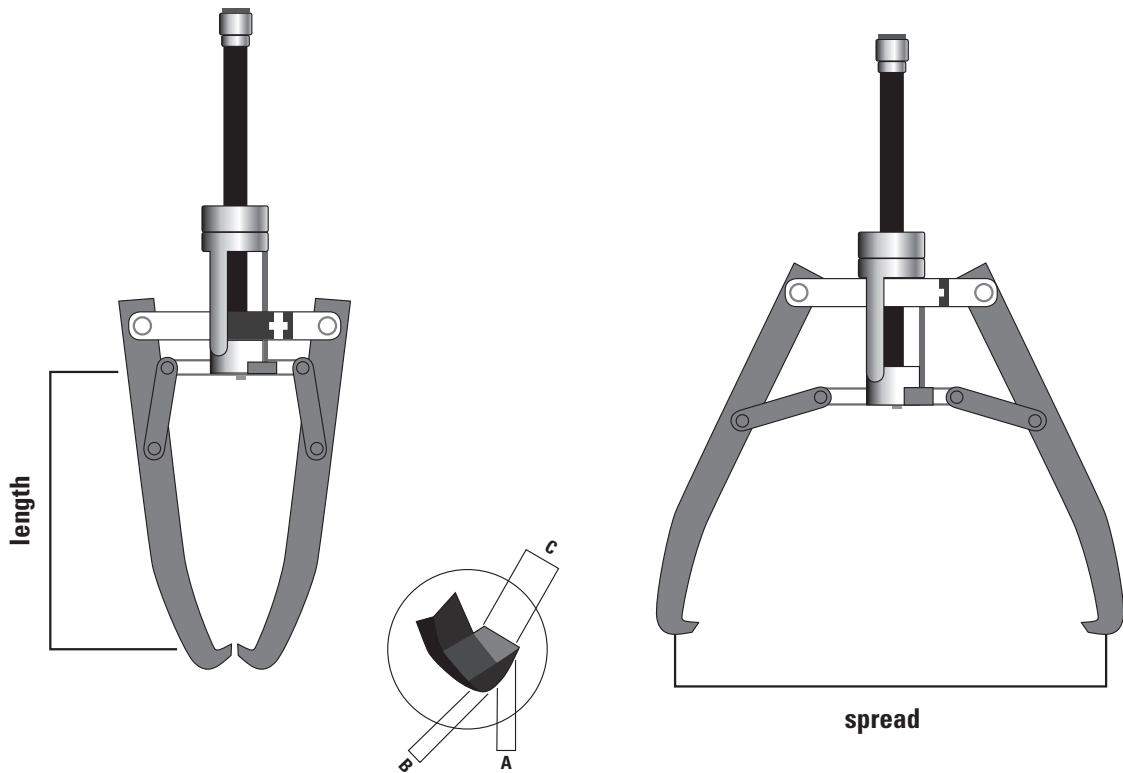

# NOTES



Lined writing area consisting of multiple horizontal orange lines.







**⚠ UWAGA! Nie zastosowanie się do poniższych ostrzeżeń może skutkować powstaniem ryzyka poważnych uszkodzeń ciała.**

Bardzo ważna jest odpowiednia konserwacja i obsługa łożysk. Nieprzestrzeganie przygotowanej przez producenta instrukcji montażu i brak właściwego smarowania może doprowadzić do awarii urządzeń.

Nigdy nie należy wprawiać łożyska w ruch przy użyciu sprężonego powietrza. Może to doprowadzić do wypadnięcia wałeczków z kosza z dużą siłą.

**Note**

Firma Timken z ogromną starannością przygotowała i wydała ten katalog, lecz w żadnym wypadku nie ponosi odpowiedzialności za jakiegokolwiek błąd lub pominięcia. Timken zastrzega sobie prawo do wprowadzania zmian w treści tego katalogu bez uprzedzenia. Treść tego katalogu jest własnością The Timken Company i nie wolno jej powielać, w żadnej formie, w całości lub częściowo, bez pisemnej zgody The Timken Company. Wszelkie dane o przeznaczeniu łożysk obejmują tylko okres do daty podanej na okładce katalogu.

**⚠ POZOR! Přehlédnutí následujícího varování může zapříčinit nebezpečí vážného zranění.**

Řádné postupy údržby a manipulace jsou nezbytnými předpoklady. Nedodržení instrukcí výrobce vozidla na instalaci a zanedbání řádného mazání může způsobit selhání zařízení s následkem rizika vážného zranění.

Nikdy neroztácejte ložisko stlačeným vzduchem. Valivé prvky mohou být prudce vymrštnuty a mohou způsobit vážné zranění.

**POZNÁMKA**

Společnost Timken mimořádně dbá na vývoj a výrobu tohoto katalogu, ale nemůže být za žádných okolností odpovědná za jakékoli chyby či opomenutí. Timken si vyhrazuje právo upravit obsah tohoto katalogu bez předchozího oznámení. Obsah tohoto katalogu je majetkem The Timken Company a nesmí být reprodukován v žádné formě, celý či částečně, bez písemného povolení The Timken Company. Údaje o použitelnosti dílů jsou uvedeny k datu vydání katalogu, které je uvedeno na přebalu.

**⚠ AVERTISMENT! Nerespectarea următoarelor avertismente poate provoca accidente grave.**

Mentenanța potrivită și practicile de manipulare sunt esențiale. Nerespectarea instrucțiunilor de instalare ale producătorului vehiculului și de mentinere a ungerii corespunzătoare pot determina pana echipamentului, existând riscuri de rănire gravă.

Nu curățați niciodată un rulment cu aer comprimat. Rolele pot fi expulzate cu putere, existând riscuri de rănire gravă.

**Notă**

Timken a acordat o grijă deosebită în cercetarea și crearea acestui catalog, dar nu își asumă responsabilitatea pentru orice eroare sau omisiune. Timken își rezervă dreptul să modifice conținutul acestui catalog fără notificare prealabilă. Conținutul acestui catalog este proprietatea Companiei Timken și nu poate fi reproduș, sub nici o formă, integral sau parțial, fără aprobarea în scris din partea Companiei Timken. Catalogul conține detalii ale aplicațiilor apărute până la data publicării acestuia, dată înscrisă pe copertă.

**⚠ FIGYELMEZTETÉS! A következő utasítások be nem tartása akár súlyos testi sérülést is okozhat.**

A megfelelő karbantartási és kezelési gyakorlat döntő jelentőségű. A gépjárműgyártó beépítési utasításainak be nem tartása és a megfelelő kenés elmulasztása a berendezés meghibásodását okozhatja, akár súlyos testi sérülés kockázatát okozva ezzel.

Soha ne forgasson csapágyat sűrített levegővel. A görgők elszabadulhatnak, ami következtében fennállhat a sérülés veszélye.

**Nota**

A Timken rendkívüli gondossággal járt el jelen katalógus vizsgálatában és előállításában, azonban semmilyen körülmények között sem lehet felelős bármely hibáért vagy hiányosságért. A Timken fenntartja a jogot jelen katalógus tartalmának előzetes értesítés nélküli módosítására. Jelen katalógus tartalma a The Timken Company tulajdonát képezi, és a The Timken Company írásos engedélye nélkül semmilyen formában nem reprodukálható, egészében vagy részben sem. Az alkalmazási adatok csak a katalógus gyártási dátumát megelőző évjáratú járművekre érvényesek.

**⚠ ВНИМАНИЕ! Несоблюдение следующих предупреждений может привести к серьезным травмам и повреждениям.**

















Важно соблюдать правильные методы технического обслуживания и обращения с подшипниками. Несоблюдение указаний компании-изготовителя автомобиля по монтажу и надлежащему поддержанию подшипников в смазанном состоянии может привести к отказу оборудования, сопряженному с риском получения тяжелой травмы.

Никогда не вращайте подшипник при помощи сжатого воздуха. Это может привести к вы抛су из него роликов.

**ПРИМЕЧАНИЕ**

Компания Timken приняла все возможные меры при проведении исследований и подготовке этого каталога, однако ни при каких обстоятельствах не может нести никакой ответственности за любые ошибки или пропуски. Компания Timken оставляет за собой право внесения изменений в этот каталог без предварительного уведомления. Содержание этого каталога является собственностью The Timken Company и не может воспроизводиться в любой форме, полностью или частично, без письменного разрешения The Timken Company. Актуальность всей технической информации соответствует дате, указанной на титульном листе каталога.

Symbol	P	PL	CZ	HU	RO	RU
	Eixo	Oś	náprava	Futómű	Osie	Мост
	Eixo rígido	Oś sztywna	Tuhá osa	Merev tengely	Osie rigidă	Зависимая подвеска
	Eixo semi-rígido	Oś półsztywna			Osie semirigidă	Полузависимая подвеска
	Eixo direccional	Oś kierowana	Hřídel řízení	Kormányzott futómű	Ax de direcție	Управляемый мост
	Manga de eixo	Zwrotnica (osi przedniej)		Tengelycsukló	Fuzetă	Поворотный кулак
	Eixo duplo	Układ dwóch osi posobnych	Tandemová hřídel	Kettős tengely	Osie în tandem	Спаренный мост
	Roda	Koła jezdne pojedyncze	Jedno kolo	Szimpla kerék	Roată simplă	Односкатное колесо
	Rodas gémeas	Koła jezdne bliźniacze	Zdvojená kola	Dupla kerék	Roți pereche	Двухскатное колесо
	Rodas de disco	Koła tarczowe		Keréktárcsa	Roată plină	Дисковое колесо
	Rodas de raio	Koła szprychowe		Kerékküllő	Roată cu spițe	Спичевое колесо
	Cubo de roda	Piasta	Náboj	Kerékagy	Butuc de roată	Ступица
	ABS	ABS	ABS	ABS	ABS	АБС
	Sem ABS	bez ABS-u	Bez ABS	nincs ABS	Fără ABS	без АБС
	Travões de disco	Hamulce tarczowe	kotoučová brzda	Tárcsafék	Frână cu disc	Дисковые тормоза
	Travões de tambor	Hamulce bębnowe	bubnová brzda	Dobfék	Frână cu tambur	Барабанные тормоза
	Mola de lâminas	Resor Piórowy	Listová pružina	Laprugó	Arc cu foi	Рессорная подвеска
	Suspensão pneumática	Zawieszenie pneumatyczne	Vzduchové pérování	Légrugó	Pernă de aer	Пневматическая подвеска
	Trilex	Koła jezdne typu Trilex	Trilex	Trilex kerék	Trilex	Обод «трилекс»
	Sem Trilex	Bez kół jezdnych typu Trilex	Bez trilexu	Trilex nélkül	Fără Trilex	Обычный обод
	Lubrificado a óleo	Smarowany olejem	Mazaný olejem	Olajkenés	Lubrificate cu ulei	Смазывание жидкой смазкой
	Lubrificado a massa	Smarowany smarem stałym	Mazaný tukem	Zsírkénés	Lubrificate cu vaselină	Смазывание густой смазкой
	Com cubo centrado	Z centrowaniem na piaście			Cu centrare pe butuc	С центрированием по ступице
	Sem cubo centrado	Bez centrowania na piaście			Fără centrare pe butuc	Без центрирования по ступице
	Com redução do cubo	Z redukcją na piaście	S redukcí v náboji		Cu reducție pe butuc	Со ступичным редуктором
	Sem redução do cubo	Bez redukcji na piaście	Bez redukcje v náboji		Fără reducție pe butuc	Без понижающего редуктора
	Roda de ligação de montagem dupla	Podwójnie mocowane koło zestawu tocznego			Roată conducătoare dublă	Сдвоенное свободное колесо
	Porca de bloqueio	Śruba zaciskowa		Biztosító anya	Piuliță de blocare	Контрольная гайка
	Roda de ligação de montagem simples	Pojedyńczo mocowane koło zestawu tocznego			Roată conducătoare simplă	Одинарное свободное колесо
	Suspensão de trapézio	Zawieszenie trapezowe		Trapéz felfüggesztés	Suspensie trapezoidală	Трапецидальная балка
	Fila única de rolamentos de roletes cônicos	Jednorzędowe łożysko stożkowe	Jednořadé kuželkové ložisko	Egyszeres kúpörgős csapágy	Rulment conic pe un singur rând	Конический однорядный подшипник
	Com redução simples	Z pojedynczą redukcją			Cu transmisie simplă	С одноступенчатым понижением
	Com vedante preto	Z czarnym uszczelnieniem	S černým těsněním	Fekete tömítéssel	Cu etanșare neagră	С черным уплотнением
	Com vedante azul	Z nebieskim uszczelnieniem	S modrým těsněním	Kék tömítéssel	Cu etanșare albastră	С синим уплотнением
	Com molas suaves	Z miękkimi resorami	S měkkou pružinou	Lágyrugóval	Cu arcuri moi	С мягкими пружинами
	Com molas rígidas	Ze sztywnymi resorami	S tvrdou pružinou	Merev rugóval	Cu arcuri rigide	С жесткими пружинами
	Ch. SCANIA Sodertälje 1242205 - - Ch. SCANIA Zwolle 4397541 - - Ch. SCANIA Angers 9034654 - - Ch. SCANIA Katrineholm 1833391					

Symbol	GB	E	F	D	I
	Axle	Eje	Essieu	Achse	Asse
	Rigid Axle	Eje Rígido	Essieu rigide	Starrachse	Assale rígido
	Semi Rigid Axle	Eje semi-rígido	Essieu semi-rigide	Schräglenkerachse	Assale semi rigido
	Steering Axle	Eje de dirección	Essieu de direction	Lenkachse	Assale sterzante
	Stub Axle	Mangueta	Essieu fusée	Achsschenkel	Assale fuso
	Tandem Axle	Eje tandem	Essieu double	Tandemachse	Assale tandem
	Single Wheel	Rueda simple	Roue simple	Einzelrad	Ruota singola
	Twin Wheels	Ruedas gemelas	Roue jumelée	Zwillingsrad	Ruote gemellate
	Disc Wheels	Ruedas de disco	Moyeu disque	Radscheiben	Ruote a disco
	Spoke Wheels	Ruedas de disco perforado	Moyeu étoile	Zackenscheiben	Ruote a razze
	Hub	Buje	Moyeu	Radnabe	Mozzo
	With ABS	Con ABS	ABS	ABS	ABS
	Without ABS	Sin ABS	Sans ABS	Kein ABS	senza ABS
	Disc Brake	Frenos de disco	Freins à disques	Scheibenbremsen	Freni a disco
	Drum Brake	Frenos de tambor	Freins à tambour	Trommelbremsen	Freni a tamburo
	Leaf Spring	Ballesta	Ressort à lames	Blattfeder	Balestra a lame
	Air Suspension	Suspensión neumática	Suspension pneumatique	Lufffederung	Sospensioni ad aria
	Trilex	Trilex	Trilex	Trilex	Trilex
	Without Trilex	Sin Trilex	Sans Trilex	Ausser Trilex	Eccetto Trilex
	Oil Lubricated	Lubricado con aceite	Lubrification à l'huile	Ölgeschmiert	Lubrificato ad olio
	Grease Lubricated	Lubricado con grasa	Lubrification à la graisse	Fettgeschmiert	Lubrificato a grasso
	With Hub Centration	Con cubo centrado	Avec centrage de moyeu	Mit Nabenzentrierung	Con mozzo centrale
	Without Hub Centration	Sin centrado del cubo	Sans centrage de moyeu	Ohne Nabenzentrierung	Senza mozzo centrale
	With Hub Reduction	Con reducción en cubo	Avec réducteur dans le moyeu	Mit Nabenverkleinerung	Con riduzione mozzo
	Without Hub Reduction	Sin reducción en cubo	Sans réducteur dans le moyeu	Ohne Nabenverkleinerung	Senza riduzione mozzo
	Double Mounted Trailing Wheel	Rueda gemela portante	Essieu suiveur roues jumelées	Nicht angetriebenes Zwillingsrad	Ruote folle doppia
	Locking Nut	Tuerca de cierre	Ecrou	Sechskantmutter	Dado di bloccaggio
	Single Mounted Trailing Wheel	Rueda sencilla portante	Essieu suiveur roues simples	Nicht angetriebenes Einzelrad	Ruote folle singola
	Trapeze Suspension	Suspensión trapeze	Suspension trapeze	Trapezfederung	Sospensioni a trapezio
	Single Row Tapered Roller Bearing	Rodamiento de rodillos cónicos	Roulement à rouleaux coniques	Einreihiges Kegelrollenlager	Cuscinetto a rulli conici a singola file
	With Single Reduction	Con reducción simple	Sans réducteur dans le moyeu	Mit einfacher Untersetzung	Con sigola riduzione
	With Black Seal	Con retén de aceite negro	Avec joint noir	Mit schwarzer Dichtung	Con guarnizione nera
	With Blue Seal	Con retén de aceite azul	Avec joint bleu	Mit blauer Dichtung	Con guarnizione blu
	With Soft Springs	Ballestas blandas	Suspension souple	Mit weicher Feder	Con molle morbide
	With Stiff Springs	Ballestas duras	Suspension renforcée	Mit starrer Feder	Con molle rigide
	Ch. SCANIA Sodertajle 1242205 - - Ch. SCANIA Zwolle 4397541 - - Ch. SCANIA Angers 9034654 - - Ch. SCANIA Katrineholm 1833391				



# TIMKEN

Where You Turn

Bearings • Specialty Steel •  
Precision Components • Lubrication •  
Seals • Remanufacture and Repair •  
Engineering Services

[www.timken.com](http://www.timken.com)

Timken® is a registered trademark of  
The Timken Company

© 2011 The Timken Company  
Printed in Europe.  
Order No. E0374

